

# MAX8831

## High-Efficiency, White LED Step-Up Converter with I<sup>2</sup>C Interface in 2mm x 2mm WLP

### General Description

The MAX8831 integrates a 60mA, 28V PWM DC-DC step-up converter with five low-dropout LED current regulators for display and keypad backlighting in cell phones, PDAs, and other portable devices. The IC provides up to 90% efficiency over the entire input voltage range of 2.7V to 5.5V. The step-up converter operates at a fixed 2MHz switching frequency, enabling the use of very small external components to achieve a compact circuit area. For improved efficiency, the step-up converter automatically transitions to pulse-skipping mode at light loads.

Each of the five current regulators accommodates up to 9 series LEDs (depending on LED string forward voltage), and is independently programmed using an I<sup>2</sup>C interface. Two of the current regulators (LED1, LED2) are intended to support display backlight functions and are programmable up to 25mA using a 128-step logarithmic dimming scheme. The other three regulators (LED3, LED4, LED5) are suitable for keyboard backlight functions or for driving signal indicators, and are programmable up to 5mA using a 32-step logarithmic dimming scheme. The low-current regulators (LED3, LED4, LED5) can be operated from the step-up converter or from a separate low-voltage source.

The I<sup>2</sup>C interface controls all operational aspects of the current regulators, including: on/off state, LED current, ramp-up/ramp-down timers, and blink rate timers (LED3, LED4, LED5). The MAX8831 write/read addresses are factory programmed at 0x9A/0x9B (contact the factory for other address options).

The MAX8831 features open/short LED fault detection, output overvoltage protection, thermal shutdown, and open-circuit Schottky diode detection, with the status of each fault monitored continually for readback through the I<sup>2</sup>C interface.

The MAX8831 is available in a tiny 2mm x 2mm, 16-bump WLP package.

### Applications

- Cell Phones
- PDAs
- Smartphones

### Benefits and Features

- Highly Integrated 28V Step-Up DC-DC Converter with Programmable Functionality Lowers System Cost
  - Integrated NMOS Power Switch
- Two 25mA Regulators for Display Backlighting
  - I<sup>2</sup>C-Programmable 50µA to 25.25mA Output Current
  - 128-Step Logarithmic Dimming
  - Individually Programmable Ramp (Up/Down) Timers
  - Low Dropout (200mV max)
- Three 5mA Current Regulators for Keypad Lighting with I<sup>2</sup>C-Programmable 50µA to 5.0mA Output Current
  - 32-Step Logarithmic Dimming
  - Individually Programmable Ramp (Up/Down) Timers
  - Individual Blink Rate and Duty Cycle Timers
  - Low Dropout (150mV max)
  - I<sup>2</sup>C Programmable Compatible with 1.8V Logic
- Protection Features Increase Reliability
  - Open/Short LED and Open-Circuit Diode Detection
  - Thermal-Shutdown and Output Overvoltage Protection
- High Efficiency and Low Shutdown Current Extend Battery Life
  - > 90% Efficiency
  - Pulse Skipping for Improved Light-Load Efficiency
  - Ultra-Low 0.1µA Shutdown Current
- Small Solution Size Saves Board Space
  - Tiny 2mm x 2mm, 16-Bump WLP Package
  - 2MHz Switching Frequency Allows Use of Tiny External Components

### Ordering Information

PART	TEMP RANGE	PIN-PACKAGE
MAX8831EWE+T	-40°C to +85°C	16 WLP 2mm x 2mm

+Denotes a lead(Pb)-free/RoHS-compliant package.

T = Tape and reel.

## Absolute Maximum Ratings

IN to GND .....	-0.3V to +6.0V
V <sub>DD</sub> , COMP to GND .....	-0.3V to (V <sub>IN</sub> + 0.3V)
SDA, SCL to GND .....	-0.3V to (V <sub>DD</sub> + 0.3V)
OUT, LX, LED1–LED5 to GND .....	-0.3V to +30V
I <sub>LX</sub> (Note 1) .....	1.2A <sub>RMS</sub>
PGND to GND .....	-0.3V to +0.3V
Operating Temperature Range .....	-40°C to +85°C

Continuous Power Dissipation (T <sub>A</sub> = +70°C) 16-Bump, 2mm x 2mm WLP (derate 8.2mW/°C above +70°C ambient) .....	660mW
Junction Temperature .....	+150°C
Storage Temperature Range .....	-65°C to +150°C
Bump Temperature (soldering, reflow) .....	+260°C

**Note 1:** LX has an internal clamp diode to PGND. Applications that forward bias this diode should take care not to exceed the power dissipation limits of the device.

Stresses beyond those listed under “Absolute Maximum Ratings” may cause permanent damage to the device. These are stress ratings only, and functional operation of the device at these or any other conditions beyond those indicated in the operational sections of the specifications is not implied. Exposure to absolute maximum rating conditions for extended periods may affect device reliability.

## Electrical Characteristics

(V<sub>IN</sub> = 3.6V, V<sub>GND</sub> = V<sub>PGND</sub> = 0V, V<sub>DD</sub> = 1.8V, T<sub>A</sub> = -40°C to +85°C, unless otherwise noted. Typical values are at T<sub>A</sub> = +25°C.) (Note 1)

PARAMETER	CONDITIONS		MIN	TYP	MAX	UNITS
IN Supply Voltage			2.7		5.5	V
V <sub>DD</sub> Supply Voltage			1.6		5.5	V
IN Undervoltage Lockout Threshold			2.4		2.6	V
IN Quiescent Current	No load, 2MHz switching			1.5		mA
IN Shutdown Current	V <sub>DD</sub> = GND	T <sub>A</sub> = +25°C		0.1	1	μA
		T <sub>A</sub> = +85°C		0.1		
V <sub>DD</sub> Standby Current	V <sub>SDA</sub> = V <sub>SCL</sub> = V <sub>DD</sub>	T <sub>A</sub> = +25°C		0.1	1	μA
		T <sub>A</sub> = +85°C		0.1		
IN Standby Current	V <sub>SDA</sub> = V <sub>SCL</sub> = V <sub>DD</sub>	T <sub>A</sub> = +25°C		2	5	μA
		T <sub>A</sub> = +85°C		2		
OUT Leakage Current	V <sub>IN</sub> = V <sub>OUT</sub> = 5.5V, V <sub>DD</sub> = GND	T <sub>A</sub> = +25°C		0.01	1	μA
		T <sub>A</sub> = +85°C		0.1		
<b>LED_ CURRENT REGULATORS</b>						
LED_ Current Regulator Dropout Voltage (Note 2)	I <sub>LED1</sub> or I <sub>LED2</sub> = 25mA setting				200	mV
	I <sub>LED3</sub> or I <sub>LED4</sub> or I <sub>LED5</sub> = 5.0mA setting				150	mV
LED_ Current Accuracy	I <sub>LED1</sub> or I <sub>LED2</sub> = 25.25mA setting	T <sub>A</sub> = +25°C		-2	+2	%
		T <sub>A</sub> = -40°C to +85°C		-5	+5	
	I <sub>LED3</sub> or I <sub>LED4</sub> or I <sub>LED5</sub> = 5.0mA setting	T <sub>A</sub> = +25°C		-2	+2	%
		T <sub>A</sub> = -40°C to +85°C		-5	+5	
LED_ Leakage Current	V <sub>LED_</sub> = 5.5V, V <sub>DD</sub> = GND	T <sub>A</sub> = +25°C		0.01	1	μA
		T <sub>A</sub> = +85°C		0.1		
LED_ Regulation Voltage				0.35		V
<b>N-CHANNEL SWITCH</b>						
LX Current Limit			780	860		mA
LX On-Resistance	I <sub>LX</sub> = 200mA			0.3		Ω

**Electrical Characteristics (continued)**(V<sub>IN</sub> = 3.6V, V<sub>GND</sub> = V<sub>PGND</sub> = 0V, V<sub>DD</sub> = 1.8V, T<sub>A</sub> = -40°C to +85°C, unless otherwise noted. Typical values are at T<sub>A</sub> = +25°C.) (Note 1)

PARAMETER	CONDITIONS	MIN	TYP	MAX	UNITS
LX Leakage Current	V <sub>IN</sub> = V <sub>LX</sub> = 5.5V, V <sub>DD</sub> = GND	T <sub>A</sub> = +25°C	0.01	1	μA
		T <sub>A</sub> = +85°C	0.1		
<b>OSCILLATOR</b>					
Operating Frequency		1.8	2	2.2	MHz
Maximum Duty Cycle	V <sub>LED1</sub> or V <sub>LED2</sub> = 0.2V	87	92	100	%
Minimum On-Time	Skip mode		30		ns
<b>COMP</b>					
Soft-Start Charge Current			-20		μA
COMP Input Resistance to GND	Step-up converter off		20		kΩ
<b>I<sup>2</sup>C INTERFACE</b>					
SDA, SCL Logic Input High Voltage	V <sub>DD</sub> = 1.6V to 5.5V	0.7 x V <sub>DD</sub>			V
SDA, SCL Logic Input Low Voltage	V <sub>DD</sub> = 1.6V to 5.5V			0.3 x V <sub>DD</sub>	V
SDA Output Low Voltage	I <sub>SDA</sub> = 3mA		0.03	0.4	V
SDA, SCL Logic Input Current	V <sub>IL</sub> = 0V or V <sub>IH</sub> = 5.5V	T <sub>A</sub> = +25°C	0.01	1	μA
		T <sub>A</sub> = +85°C	0.1		
<b>FAULT PROTECTION</b>					
Thermal Shutdown	Temperature rising		+160		°C
Thermal-Shutdown Hysteresis			20		°C
Output Overvoltage Threshold	V <sub>OUT</sub> rising	28		30	V
Output Overvoltage Hysteresis			4		V
Open LED_ Sense Voltage	LED_ enabled, measured at LED_		100	120	mV
Shorted LED_ Sense Voltage	LED_ enabled, measured at LED_, V <sub>OUT</sub> = 10V	V <sub>OUT</sub> - 2.2V		V <sub>OUT</sub> - 0.7V	V
Open/Short LED Debounce Timer			16		ms

## I<sup>2</sup>C Interface Timing Characteristics

(V<sub>DD</sub> = 1.6V to 5.5V, T<sub>A</sub> = -40°C to +85°C, unless otherwise noted.) (Note 1)

PARAMETER	SYMBOL	CONDITIONS	MIN	TYP	MAX	UNITS
I <sup>2</sup> C Clock Frequency	f <sub>SCL</sub>				400	kHz
Bus-Free Time Between STOP and START	t <sub>BUF</sub>		1.3			μs
Repeated START Condition Hold Time	t <sub>HD_STA</sub>		0.6	0.1		μs
Repeated START Condition Setup Time	t <sub>SU_STA</sub>		0.6	0.1		μs
STOP Condition Setup Time	t <sub>SU_STO</sub>		0.6	0.1		μs
SCL Clock Low Period	t <sub>LOW</sub>		1.3	0.2		μs
SCL Clock High Period	t <sub>HIGH</sub>		0.6	0.2		μs
SDA Hold Time	t <sub>HD_DAT</sub>		0	0.01		μs
SDA Setup Time	t <sub>SU_DAT</sub>		100	50		ns

**Note 1:** All devices are 100% production tested at T<sub>A</sub> = +25°C. Limits over the operating temperature range are guaranteed by design.

**Note 2:** LED dropout voltage is defined as the LED<sub>-</sub> to GND voltage when current into LED<sub>-</sub> drops 10% from the value at V<sub>LED<sub>-</sub></sub> = 0.5V.

Typical Operating Characteristics

( $V_{IN} = 3.6V$ ,  $V_{DD} = 1.8V$ ,  $C_{IN} = 1\mu F$ ,  $C_{OUT} = 1\mu F$ ,  $C_{VDD} = 0.1\mu F$ ,  $C_{COMP} = 0.22\mu F$ ,  $L = TOKO 1098AS-100M$ ,  $I_{LED1} = I_{LED2} = 25.25mA$ ,  $I_{LED3} = I_{LED4} = I_{LED5} = 5mA$ , unless otherwise noted.)

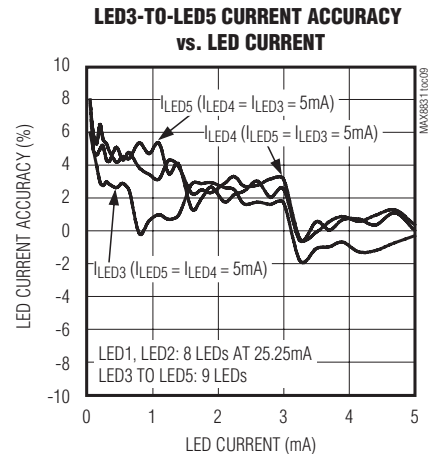
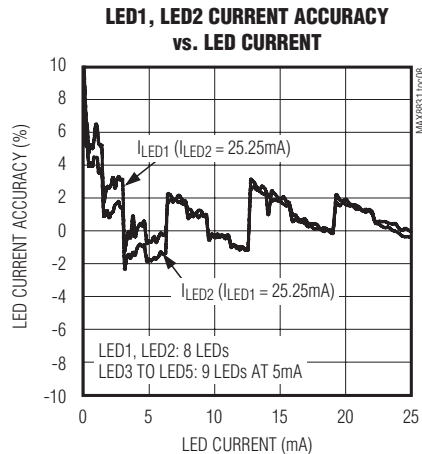
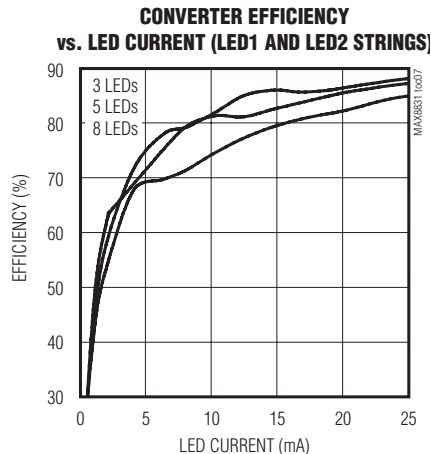
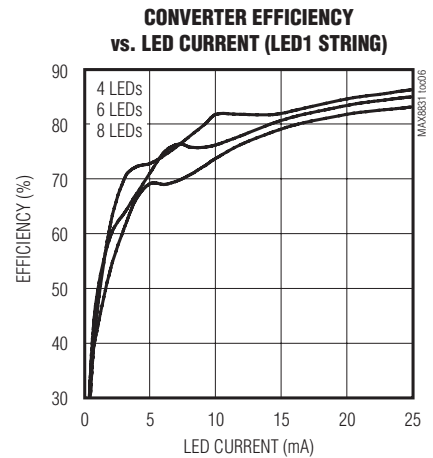
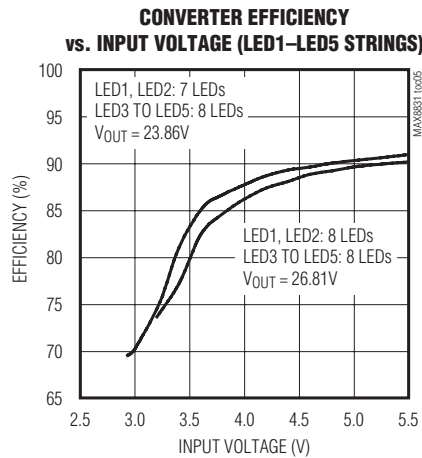
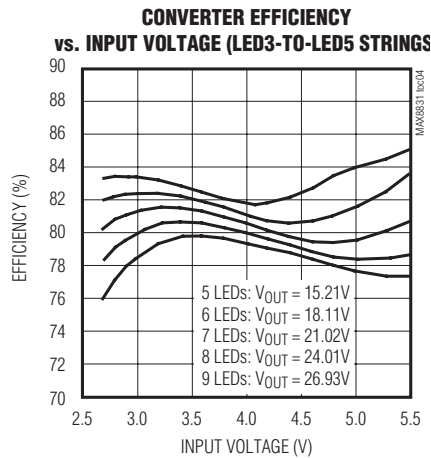
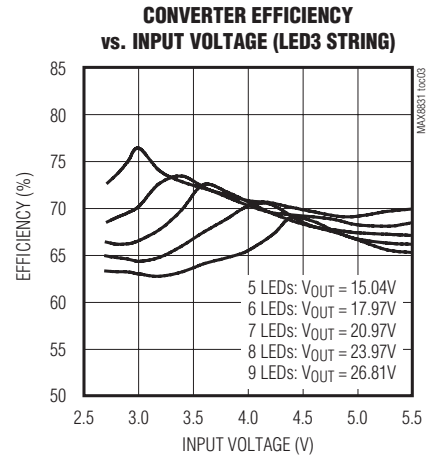
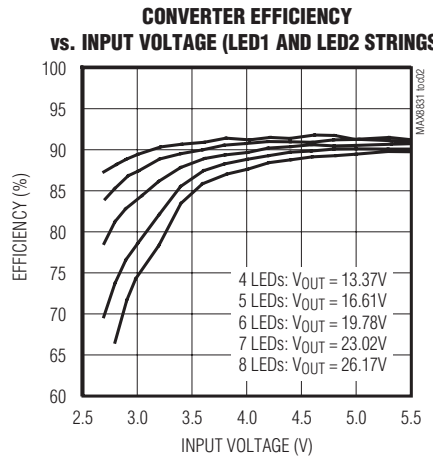
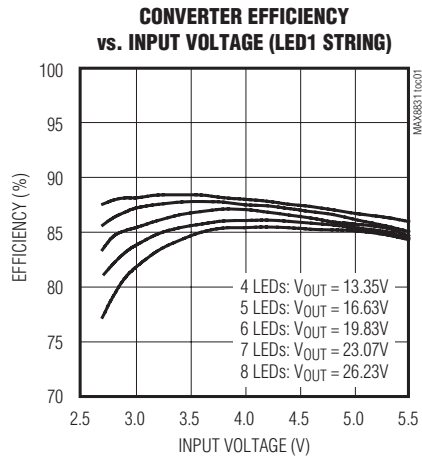

Typical Operating Characteristics (continued)

(V<sub>IN</sub> = 3.6V, V<sub>DD</sub> = 1.8V, C<sub>IN</sub> = 1μF, C<sub>OUT</sub> = 1μF, C<sub>VDD</sub> = 0.1μF, C<sub>COMP</sub> = 0.22μF, L = TOKO 1098AS-100M, I<sub>LED1</sub> = I<sub>LED2</sub> = 25.25mA, I<sub>LED3</sub> = I<sub>LED4</sub> = I<sub>LED5</sub> = 5mA, unless otherwise noted.)

LIGHT-LOAD SWITCHING WAVEFORMS

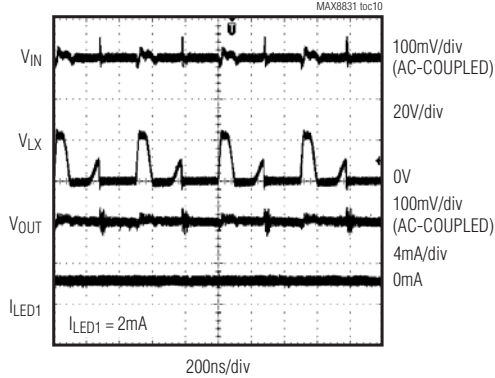

HEAVY-LOAD SWITCHING WAVEFORMS

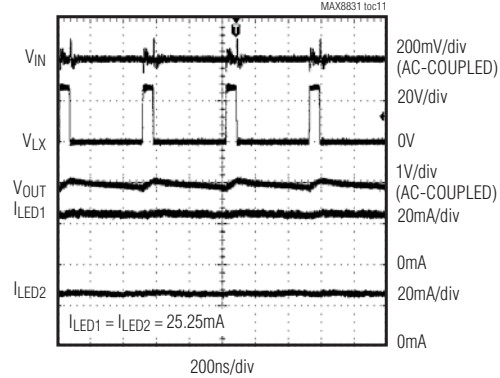

SOFT-START RESPONSE

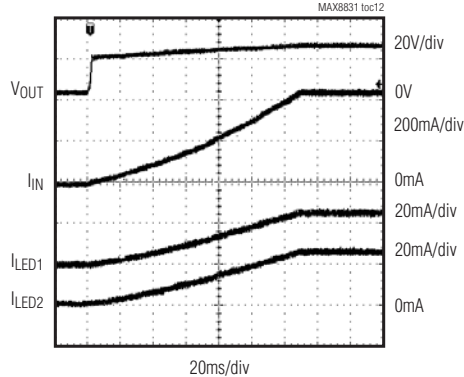

SHUTDOWN RESPONSE

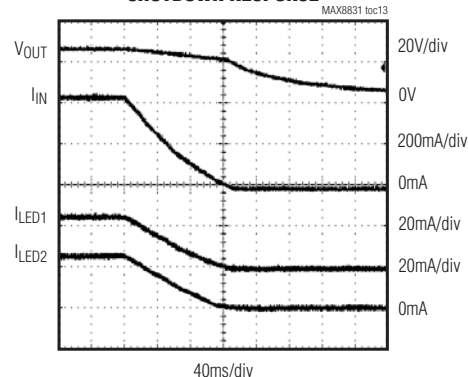

MAXIMUM OUTPUT CURRENT vs. INPUT VOLTAGE

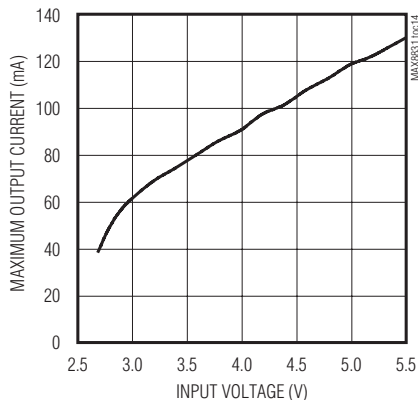

LED1, LED2 CURRENT ACCURACY vs. INPUT VOLTAGE

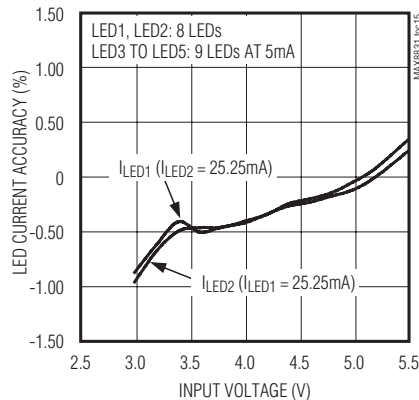

LED3-TO-LED5 CURRENT ACCURACY vs. INPUT VOLTAGE

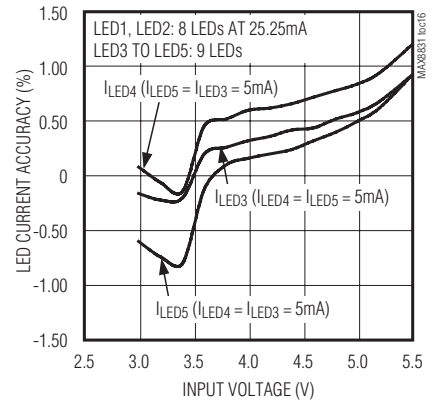

Typical Operating Characteristics (continued)

( $V_{IN} = 3.6V$ ,  $V_{DD} = 1.8V$ ,  $C_{IN} = 1\mu F$ ,  $C_{OUT} = 1\mu F$ ,  $C_{VDD} = 0.1\mu F$ ,  $C_{COMP} = 0.22\mu F$ ,  $L = TOKO 1098AS-100M$ ,  $I_{LED1} = I_{LED2} = 25.25mA$ ,  $I_{LED3} = I_{LED4} = I_{LED5} = 5mA$ , unless otherwise noted.)

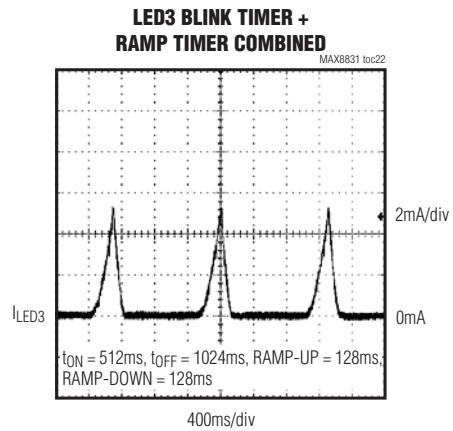
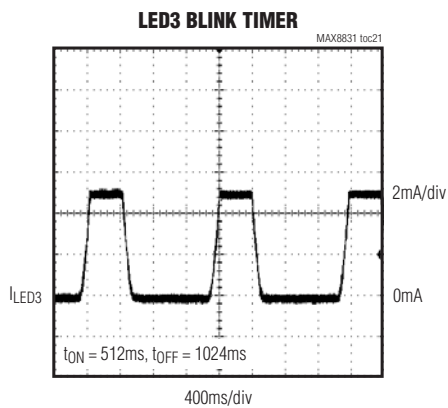
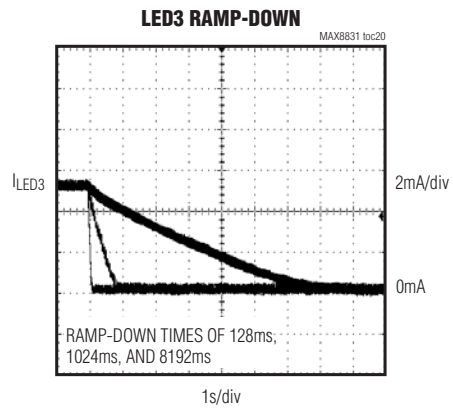
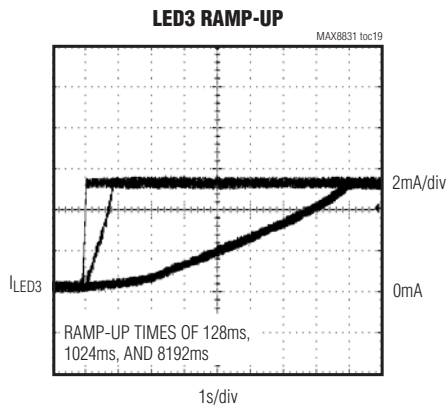
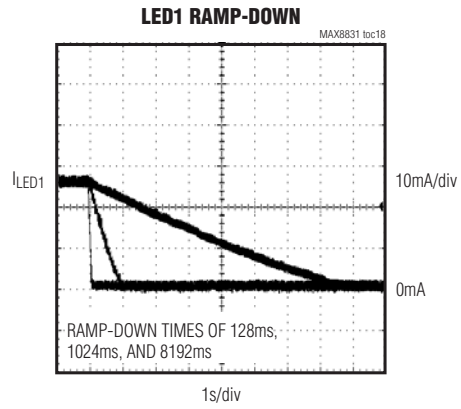
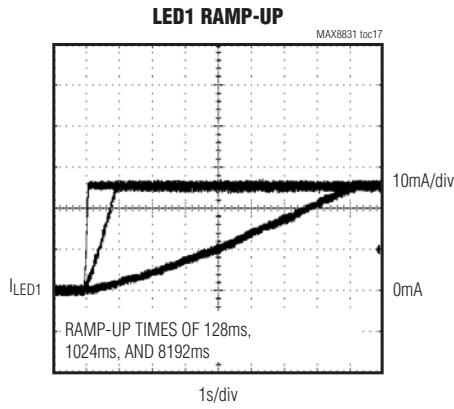

## Pin Description

PIN	NAME	FUNCTION
A1	LED1	25mA LED Current Regulator. Connect LED1 to the cathode of the LED1 diode string. LED1 is high impedance in shutdown.
A2	GND	Analog Ground. Connect GND directly to PGND at the output capacitor as close as possible to the IC.
A3	LED3	5mA LED Current Regulator. Connect LED3 to the cathode of the LED3 diode string. LED3 is high impedance in shutdown.
A4	COMP	Step-Up Compensation Node. Connect a 0.22 $\mu$ F ceramic capacitor from COMP to GND. The applied COMP capacitance stabilizes the converter and sets the soft-start time. COMP discharges to GND through a 20k $\Omega$ resistance when in shutdown. See the <i>Compensation Network Selection</i> section for more details.
B1	LED2	25mA LED Current Regulator. Connect LED2 to the cathode of the LED2 diode string. LED2 is high impedance in shutdown.
B2	LED5	5mA LED Current Regulator. Connect LED5 to the cathode of the LED5 diode string. LED5 is high impedance in shutdown.
B3	LED4	5mA LED Current Regulator. Connect LED4 to the cathode of the LED4 diode string. LED4 is high impedance in shutdown.
B4	SCL	I <sup>2</sup> C Serial-Clock Input
C1, D1	LX	Step-Up Converter Switching Node. Connect an inductor between IN and LX. LX is high impedance in shutdown.
C2, D2	PGND	Power Ground. Connect PGND directly to GND at the output capacitor as close as possible to the IC.
C3	SDA	I <sup>2</sup> C Serial-Data I/O. Data written on rising edge of SCL, data read on falling edge of SCL.
C4	V <sub>DD</sub>	I <sup>2</sup> C Input Buffer Supply. Connect a 0.1 $\mu$ F capacitor from V <sub>DD</sub> to GND as close as possible to the IC. Connect V <sub>DD</sub> to a 1.6V to 5.5V supply to enable the I <sup>2</sup> C interface. Drive V <sub>DD</sub> low to place the IC in shutdown.
D3	IN	Power-Supply Input. Bypass IN to GND with a 1 $\mu$ F ceramic capacitor placed as close as possible to the IC.
D4	OUT	LED Overvoltage Protection Input. Connect OUT to the positive terminal of the output capacitor. OUT monitors voltage at the LEDs. If an overvoltage condition is detected, all LED_ current regulators and the step-up converter are shut down. OUT is high impedance during shutdown.

## Detailed Description

The MAX8831 integrates a 60mA, 28V PWM DC-DC step-up converter with five low-dropout LED current regulators for display and keypad backlighting in cell phones, PDAs, and other portable devices. The IC provides up to 90% efficiency over the entire input voltage range of 2.7V to 5.5V. The step-up converter operates at a fixed 2MHz switching frequency, enabling the use of very small external components to achieve a compact circuit area. For improved efficiency, the step-up con-

verter automatically operates in pulse-skipping mode at light loads. Figure 1 displays the functional diagram of the MAX8831.

Each current regulator accommodates up to 9 series LEDs (depending on LED string forward voltage), and is independently programmed using an I<sup>2</sup>C interface. Two of the current regulators (LED1, LED2) are intended to support display backlight functions and are programmable up to 25.25mA using a 128-step logarithmic dimming scheme.



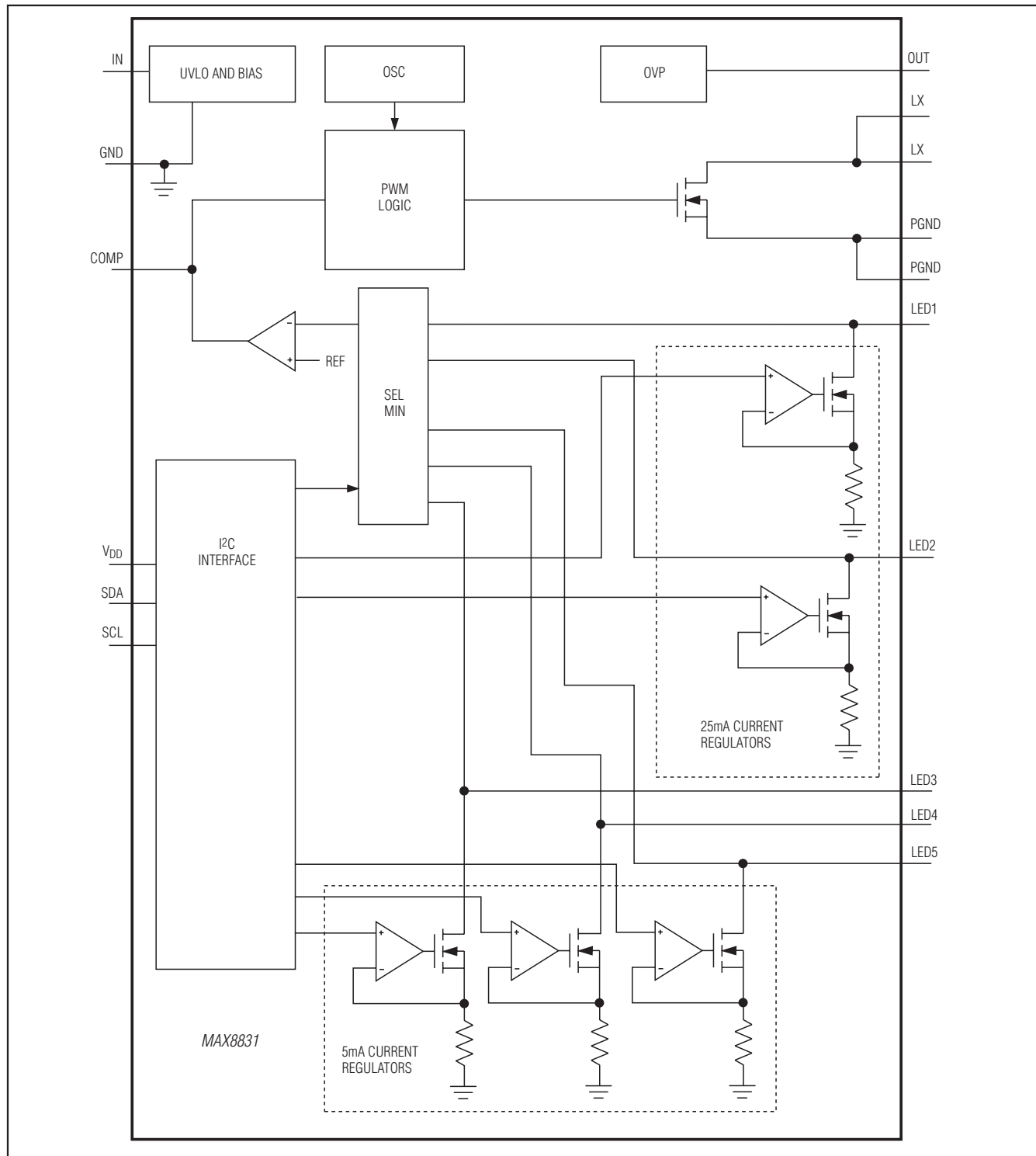

Figure 1. MAX8831 Functional Diagram

The other three regulators (LED3, LED4, LED5) are suitable for keyboard backlight functions or for driving signal indicators, and are programmable up to 5.0mA using a 32-step logarithmic dimming scheme. The low-current regulators (LED3, LED4, LED5) can be operated from the step-up converter or from a separate low-voltage source.

The I<sup>2</sup>C interface controls all operational aspects of the current regulators, including: on/off state, LED current, ramp-up/ramp-down timers, and blink rate timers (LED3, LED4, LED5). The MAX8831 I<sup>2</sup>C write/read addresses are factory set at 0x9A/0x9B (contact the factory for other address options).

The IC features several protective features, including: open/short LED fault detection, output overvoltage protection, thermal shutdown, and open Schottky diode detection. The status of each fault is monitored continually for readback through the I<sup>2</sup>C interface.

### Fixed-Frequency Step-Up Controller

The MAX8831's fixed-frequency, current-mode, step-up controller automatically chooses the lowest active LED<sub>+</sub> voltage to complete the feedback loop (Figure 1). Specifically, the difference between the lowest LED<sub>+</sub> voltage and the 350mV reference is integrated by the error amplifier. The resulting error signal is compared to the external switch current plus slope compensation to terminate the switch on-time. As the load changes, the error amplifier sources or sinks current to COMP to adjust the required peak inductor current. The slope-compensation signal is added to the current-sense signal to improve stability at high duty cycles.

At light loads, the MAX8831 automatically skips pulses to improve efficiency and to prevent overcharging the output capacitor. In SKIP mode, the inductor current ramps up for a minimum on-time of 20ns (typ), then discharges the stored energy to the output. The switch remains off until another pulse is needed to step-up the output voltage.

When the MAX8831 is programmed by the I<sup>2</sup>C interface to use an alternate supply voltage for the LED3, LED4, or LED5 string (see the *Low-Current Regulators (LED3, LED4, LED5)* section), internal logic masks that LED<sub>+</sub> input and it is not used to regulate the step-up converter output.

### High-Current Regulators (LED1, LED2)

The MAX8831 contains two low-dropout (200mV max), 25.25mA linear current regulators (LED1, LED2) that can each drive up to 9 series LEDs (depending on LED string forward voltage) for display backlighting func-

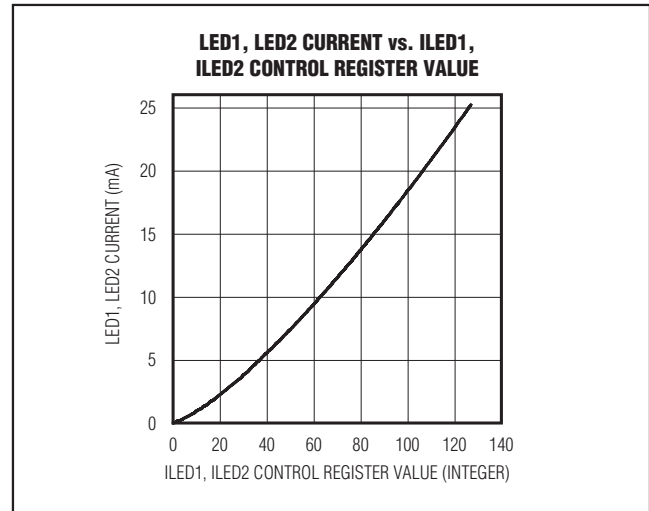

Figure 2. LED1, LED2 String Current vs. I<sub>LED1</sub>, I<sub>LED2</sub> Control Register Value

tions. Each high-current regulator is independently enabled and is programmable from 50μA to 25.25mA in 128 logarithmic steps (Table 1, Figure 2) using the I<sup>2</sup>C interface. Additionally, the I<sup>2</sup>C interface programs the ramp-up and ramp-down timers for each regulator to one of eight different timing settings. See the *MAX8831 I<sup>2</sup>C Registers* section for details on I<sup>2</sup>C control of the high-current regulators.

### Low-Current Regulators (LED3, LED4, LED5)

The MAX8831 also contains three low-dropout (150mV max), 5.0mA linear current regulators (LED3, LED4, LED5) that can each drive up to 9 series LEDs for keypad backlighting or signal indicator functions. Each current regulator is independently enabled, and is programmable from 50μA to 5.0mA in 32 logarithmic steps (Table 2, Figure 3) using the I<sup>2</sup>C interface. Individual ramp-up and ramp-down timers are programmable for LED3, LED4, and LED5, with eight possible timing settings. The individual blink ON and blink OFF timers for each low-current regulator are also programmable, or these features can be disabled. See the *MAX8831 I<sup>2</sup>C Registers* section for details.

The LED3, LED4, and LED5 low-current regulators can be powered from an alternate external source. By programming the BOOST\_CNTL register, internal logic masks that LED<sub>+</sub> input and it is not used to regulate the step-up converter output.

**Table 1. LED1, LED2 Programmable Current Levels and Register Values**

I <sub>LED_CNTRL</sub> REGISTER VALUE	I <sub>LED_</sub> (mA)	I <sub>LED_CNTRL</sub> REGISTER VALUE	I <sub>LED_</sub> (mA)	I <sub>LED_CNTRL</sub> REGISTER VALUE	I <sub>LED_</sub> (mA)
0x00	0.05	0x2B	6.15	0x56	15.15
0x01	0.1	0x2C	6.35	0x57	15.35
0x02	0.2	0x2D	6.5	0x58	15.6
0x03	0.25	0x2E	6.7	0x59	15.8
0x04	0.35	0x2F	6.9	0x5A	16.05
0x05	0.45	0x30	7.1	0x5B	16.3
0x06	0.55	0x31	7.3	0x5C	16.5
0x07	0.65	0x32	7.45	0x5D	16.75
0x08	0.75	0x33	7.65	0x5E	17
0x09	0.85	0x34	7.85	0x5F	17.25
0x0A	1	0x35	8.05	0x60	17.45
0x0B	1.1	0x36	8.25	0x61	17.7
0x0C	1.2	0x37	8.45	0x62	17.95
0x0D	1.35	0x38	8.65	0x63	18.2
0x0E	1.45	0x39	8.85	0x64	18.45
0x0F	1.6	0x3A	9.05	0x65	18.65
0x10	1.75	0x3B	9.25	0x66	18.9
0x11	1.85	0x3C	9.45	0x67	19.15
0x12	2	0x3D	9.65	0x68	19.4
0x13	2.15	0x3E	9.9	0x69	19.65
0x14	2.3	0x3F	10.1	0x6A	19.9
0x15	2.45	0x40	10.3	0x6B	20.15
0x16	2.6	0x41	10.5	0x6C	20.4
0x17	2.75	0x42	10.7	0x6D	20.65
0x18	2.9	0x43	10.9	0x6E	20.9
0x19	3.05	0x44	11.15	0x6F	21.15
0x1A	3.2	0x45	11.35	0x70	21.4
0x1B	3.35	0x46	11.55	0x71	21.65
0x1C	3.5	0x47	11.8	0x72	21.9
0x1D	3.65	0x48	12	0x73	22.15
0x1E	3.85	0x49	12.2	0x74	22.4
0x1F	4	0x4A	12.45	0x75	22.65
0x20	4.15	0x4B	12.65	0x76	22.9
0x21	4.35	0x4C	12.85	0x77	23.15
0x22	4.55	0x4D	13.1	0x78	23.4
0x23	4.7	0x4E	13.3	0x79	23.7
0x24	4.9	0x4F	13.55	0x7A	23.95
0x25	5.05	0x50	13.75	0x7B	24.2

ILED_CNTRL REGISTER VALUE	ILED_ (mA)	ILED_CNTRL REGISTER VALUE	ILED_ (mA)	ILED_CNTRL REGISTER VALUE	ILED_ (mA)
0x26	5.25	0x51	14	0x7C	24.45
0x27	5.45	0x52	14.2	0x7D	24.7
0x28	5.6	0x53	14.45	0x7E	25
0x29	5.8	0x54	14.65	0x7F	25.25
0x2A	5.95	0x55	14.9	—	—

### Soft-Start

From shutdown, once any LED\_ is enabled through the I<sup>2</sup>C interface, the IC prepares for soft-start. C<sub>COMP</sub> is quickly pulled to 1V by an internal pullup clamp. Since the LED\_ feedback node voltage is less than the regulation threshold (0.35V typ), 40μA current is sourced from the error amplifier (Figure 1) and further charges C<sub>COMP</sub>. Once V<sub>COMP</sub> reaches 1.25V, the step-up converter starts switching at a reduced duty cycle. As V<sub>COMP</sub> rises, the step-up converter duty cycle increases. When V<sub>LED\_</sub> reaches 0.35V (typ), the error amplifier stops sourcing current to C<sub>COMP</sub>, soft-start ends, and the control loop achieves regulation as V<sub>LED\_</sub> settles. The V<sub>COMP</sub> where the IC exits soft-start depends on the load. A 2.5V upper limit to V<sub>COMP</sub> is imposed to aid in transient recovery and to allow maximum output for low input voltages.

C<sub>COMP</sub> is discharged to GND through a 20kΩ internal resistor whenever the step-up converter is turned off, allowing the device to reinitiate soft-start when it is enabled. See the *Typical Operating Characteristics* for an example of soft-start operation.

### Off, Shutdown, and Standby

The MAX8831 is considered OFF when V<sub>IN</sub> is below the V<sub>UVLO</sub> threshold and V<sub>DD</sub> is below 1.6V. With V<sub>IN</sub> above the V<sub>UVLO</sub> threshold, and with V<sub>DD</sub> low, the IC enters the shutdown state and disables its internal reference. During shutdown, the MAX8831 holds all registers in reset, the step-up converter and all LED current drivers are off, and supply current is reduced to 0.1μA (typ). LX and LED1–LED5 are high impedance when the step-up converter is off.

While the n-channel MOSFET is turned off, the step-up regulator's output is connected to IN through the external inductor and Schottky diode.

With a valid supply voltage applied to V<sub>DD</sub> (greater than 1.6V) and with V<sub>IN</sub> above V<sub>UVLO</sub>, the IC enters a standby condition, whereby it is ready to accept I<sup>2</sup>C

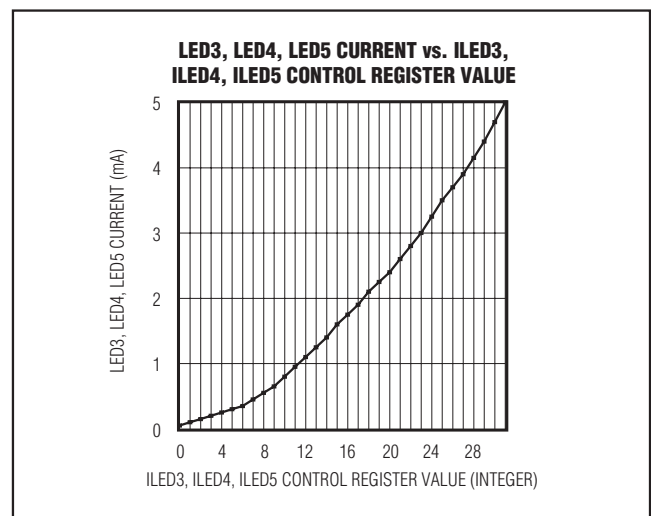

Figure 3. LED3, LED4, LED5 String Current vs. ILED3, ILED4, ILED5 Control Register Value

commands. The step-up converter turns on when any current regulator is enabled with an I<sup>2</sup>C command.

### Open/Shorted LED Detection

The MAX8831 includes two fault-detection comparators on each LED\_ input to detect an open or shorted LED condition. One comparator monitors LED\_ voltage and indicates an open LED\_ fault when V<sub>LED\_</sub> falls below 100mV. The other comparator detects when LED\_ voltage rises above V<sub>OUT</sub> - 0.7V, indicating a shorted LED fault. The fault detection comparators are enabled only when the corresponding LED\_ current regulator is enabled. Once a fault is detected, the two comparators provide a single bit output (1 = fault, 0 = no fault) to the STAT1 register (bits 0–4), corresponding to the appropriate LED regulator.

A debounce time of 16ms (typ) is applied from when a fault condition is detected. At the end of the 16ms debounce time, the status is latched in to the status

**Table 2. LED3, LED4, and LED5  
Programmable Current Levels and  
Register Values**

ILED_CNTRL REGISTER VALUE	I <sub>LED</sub> (mA)	ILED_CNTRL REGISTER VALUE	I <sub>LED</sub> (mA)
0x00	0.05	0x10	1.75
0x01	0.1	0x11	1.90
0x02	0.15	0x12	2.10
0x03	0.20	0x13	2.25
0x04	0.25	0x14	2.40
0x05	0.30	0x15	2.60
0x06	0.35	0x16	2.80
0x07	0.45	0x17	3.00
0x08	0.55	0x18	3.25
0x09	0.65	0x19	3.50
0x0A	0.80	0x1A	3.70
0x0B	0.95	0x1B	3.90
0x0C	1.10	0x1C	4.15
0x0D	1.25	0x1D	4.40
0x0E	1.40	0x1E	4.70
0x0F	1.60	0x1F	5.00

register and the respective current regulator is disabled. If an open LED condition occurs on a current regulator that is included in the adaptive output voltage regulation, the output voltage starts to rise. Depending on the converter output voltage and load condition, the output voltage can reach the OVP threshold before the 16ms debounce timer expires. In this case, the converter disables all current regulators, forces the IC into standby mode, and the status register indicates only an OVP fault.

If the BOOST\_CNTRL register is programmed to power LED3, LED4, or LED5 from an alternate source, only open LED detection is enabled for LED3, LED4, or LED5.

### Output Overvoltage Protection

The MAX8831 protects the LEDs from excessive voltage by initiating overvoltage protection (OVP) when V<sub>OUT</sub> rises above 28V (min). When OVP occurs, the MAX8831 turns off the LED current regulators by resetting all ON/OFF control register bits to 0, causing the IC to enter standby status and turn off the step-up converter. Bit 0 (OVP) of the STAT2 register is updated to a 1 to indicate that an OVP event has occurred. The step-

up converter automatically restarts after an OVP event when V<sub>OUT</sub> decreases below 25V (typ).

### Open Schottky Diode Detection

The MAX8831 detects an open external Schottky diode by sensing V<sub>OUT</sub> before turning on the step-up converter. If V<sub>OUT</sub> is above 0.8V (typ), the MAX8831 allows the step-up converter to turn on. If V<sub>OUT</sub> is less than 0.8V (typ), indicating that the external Schottky diode is open, the MAX8831 is put into standby state, the ON/OFF control register bits for the LEDs are set low, and the step-up converter stops switching. Bit 2 (OSDD) of the STAT2 register is updated to a 1 to indicate that an open Schottky diode event has occurred.

### Thermal-Shutdown Protection

When the junction temperature exceeds +160°C (typ), the ON/OFF control register bits for all LEDs are reset to low and the MAX8831 enters standby mode and the step-up converter stops switching. Bit 1 (TSD) of the STAT2 register is updated to a 1 to indicate that thermal shutdown has occurred.

### System States and Fault Handling

The MAX8831 implements two fault registers (STAT1, STAT2) to provide users with fault indication through the I<sup>2</sup>C interface.

The STAT1 register indicates a fault condition for each LED\_ string, whether a shorted or open LED\_ fault has occurred. In the event of an LED\_ fault, the corresponding bit in the STAT1 register is latched and the ON/OFF control bit for that current regulator is cleared. An I<sup>2</sup>C read of the STAT1 register causes all STAT1 bits to be cleared and the corresponding string to be reenabled. If the fault is persistent, then the corresponding bit in the STAT1 register is set again. All open/short fault monitors are subject to a 16ms blanking period to ensure that the MAX8831 does not respond to a false fault occurrence.

The second status register, STAT2, reports the following global system faults: output overvoltage-protection detection (OVP), thermal-shutdown detection (TSD), and open Schottky diode detection (OSDD). If a TSD, OVP, or OSDD fault occurs, the IC enters standby mode, the step-up converter stops switching, and all the current regulators are shut down by clearing their ON/OFF control bits. Once standby occurs, the MAX8831 does not transition back to the ON state until the STAT2 register is read, clearing the fault indication, and an I<sup>2</sup>C command enabling one or more current regulators is received.

See Figure 4 for a state diagram of the MAX8831.

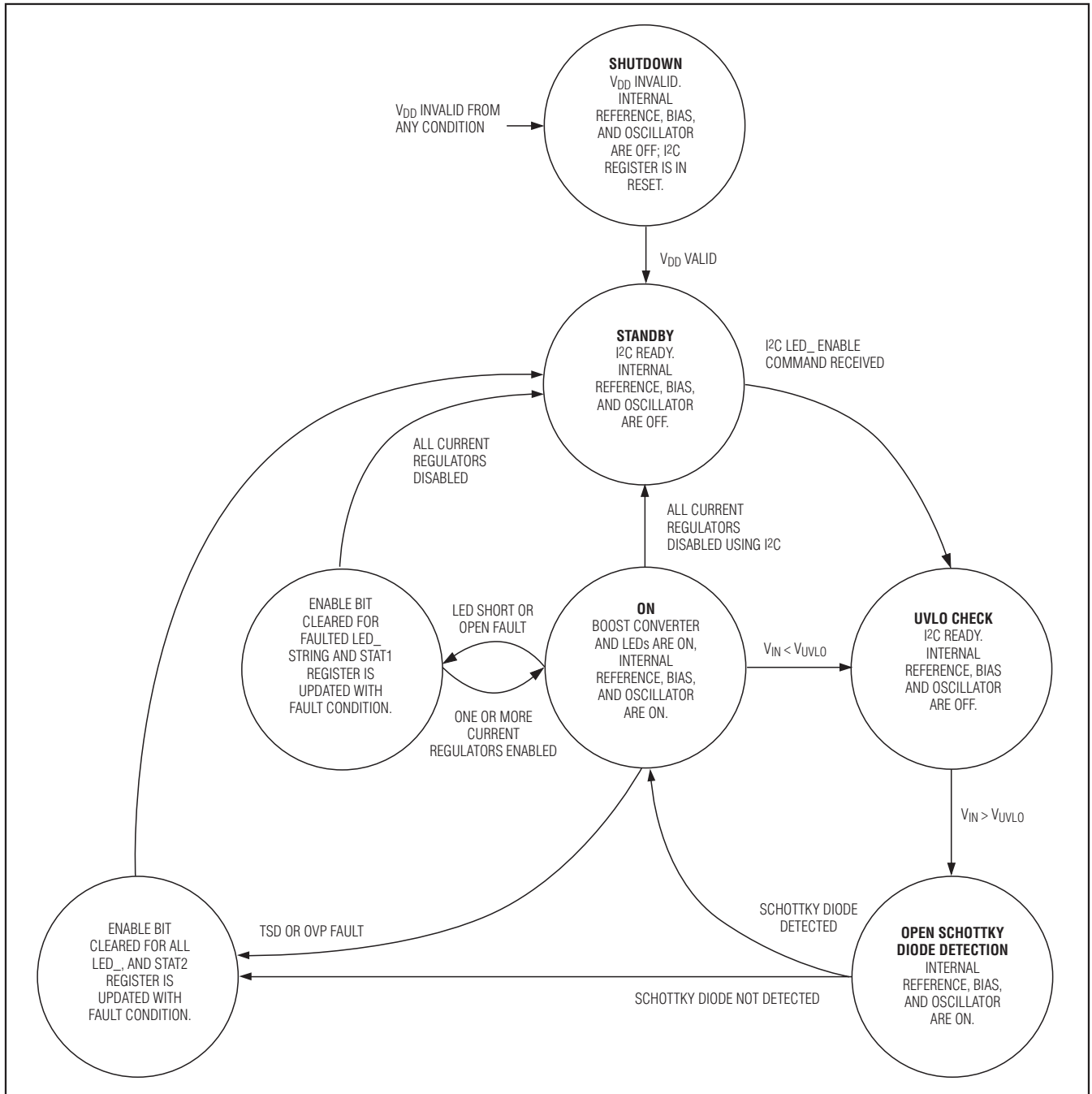
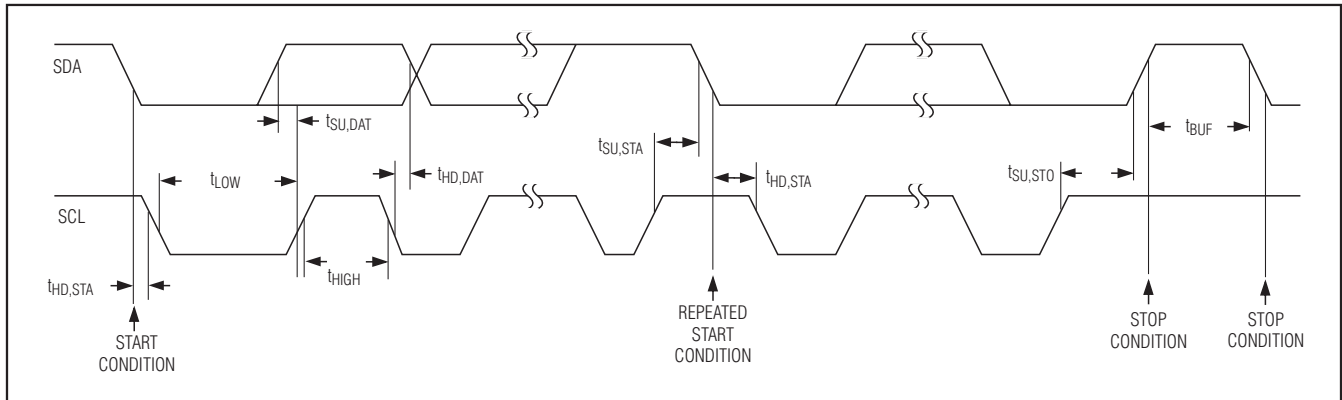
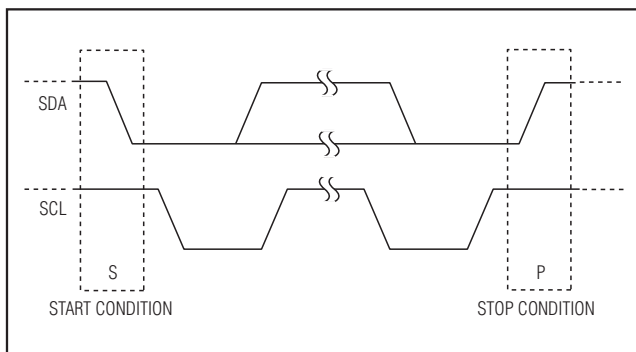

Figure 4. State Diagram of Global Faults

Figure 5. I<sup>2</sup>C Interface Timing DiagramFigure 6. I<sup>2</sup>C START and STOP Conditions

## I<sup>2</sup>C Interface

The MAX8831 operates as an I<sup>2</sup>C slave that receives and sends data through an I<sup>2</sup>C-compatible, 2-wire interface. The LED1–LED5 current settings, ramp and blink-rate timers, and other configuration parameters are set using the I<sup>2</sup>C serial interface. See the register definitions for more details.

The interface uses a serial-data line (SDA) and a serial-clock line (SCL) to achieve bidirectional communication between master(s) and slave(s). A master (typically a microcontroller) initiates all data transfers to and from the MAX8831, and generates the SCL clock that synchronizes the data transfer (Figure 5). The MAX8831 SDA line operates as both an input and an open-drain output. A pullup resistor, typically 4.7k $\Omega$ , is required on SDA. The MAX8831 SCL line operates only as an input. A pullup resistor, typically 4.7k $\Omega$ , is required on SCL if there are multiple masters on the 2-wire interface, or if the master in a single-master system has an open-drain

SCL output. Each transmission consists of a START condition (Figure 6) sent by a master, followed by the MAX8831 7-bit slave address plus a R/W bit, a register address byte, 1 or more data bytes, and finally a STOP condition (Figures 5 and 6).

### START and STOP Conditions

Both SCL and SDA remain high when the interface is not busy. The master signals the beginning of a transmission with a START (S) condition by transitioning SDA from high to low while SCL is high. When the master has finished communicating with the slave, it issues a STOP (P) condition by transitioning the SDA from low to high while SCL is high. The bus is then free for another transmission (Figure 6).

### Bit Transfer

One data bit is clocked onto SDA on the falling edge of SCL and is read on the rising edge of SCL. The data on the SDA line must remain stable while SCL transitions (Figure 7).

### Acknowledge

The acknowledge bit is a clocked 9th bit that the recipient uses to handshake receipt of each byte of data (Figure 8). Thus, each byte transferred effectively requires 9 bits. The master generates the 9th clock pulse, and the recipient pulls down SDA during the acknowledge clock pulse, such that the SDA line is stable low during the high period of the clock pulse. When the master is transmitting to the MAX8831, the MAX8831 generates the acknowledge bit because it is the recipient. When the MAX8831 is transmitting to the master, the master generates the acknowledge bit because it is the recipient.

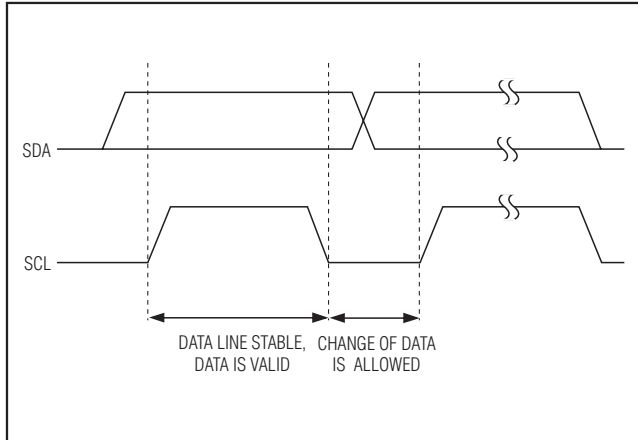

Figure 7. I<sup>2</sup>C Bit Transfer

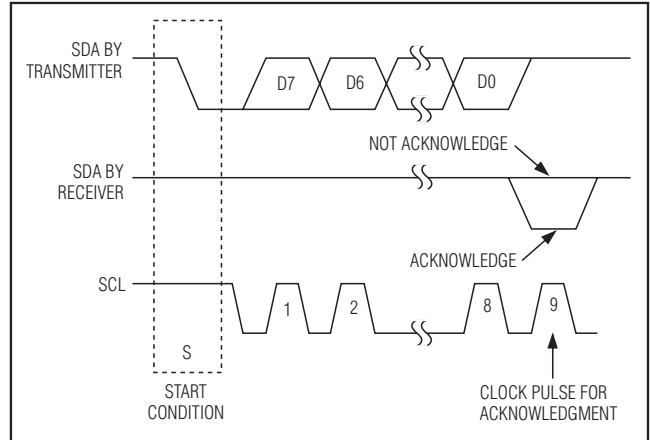

Figure 8. I<sup>2</sup>C Acknowledge

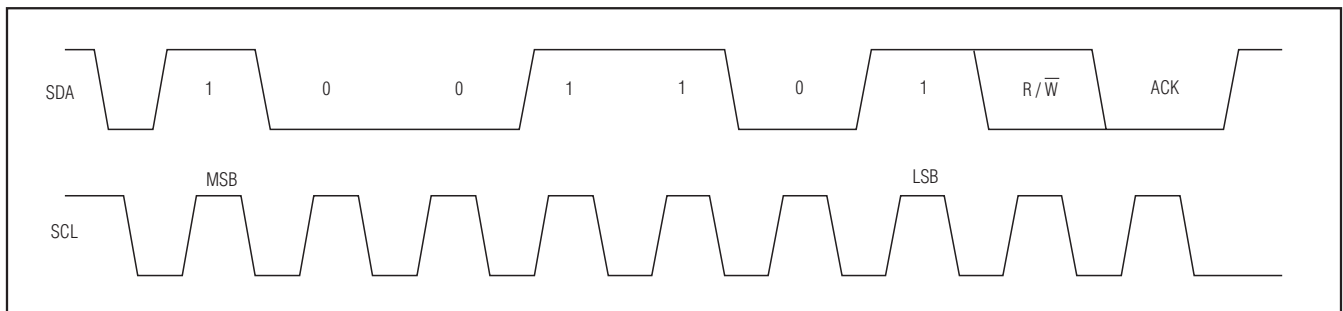

Figure 9. MAX8831 Default Slave Address

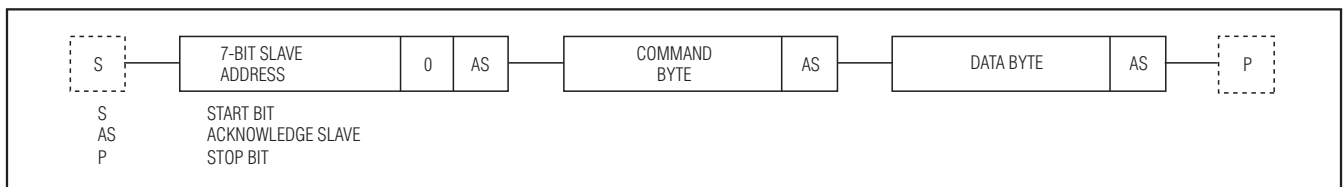

Figure 10. I<sup>2</sup>C Single-Byte Write

**MAX8831 Slave Address**

The MAX8831 has a 7-bit-long slave address (Figure 9). The eighth bit following the 7-bit slave address is the R/W bit. It is low for a write command, high for a read command. The slave addresses available for the MAX8831 are 1001101X (with a write/read address of 0x9A/0x9B). Contact the factory for other I<sup>2</sup>C address options.

**Message Format for Writing**

A write to the MAX8831 comprises the transmission of the MAX8831's slave address with the R/W bit set to zero (0x9A), followed by at least 1 byte of information. The first byte of information is the command byte (Figure 10), which determines which register of the MAX8831 is to be written by the next byte, if received. If a STOP condition is detected after the command byte is received, the MAX8831 takes no further action beyond storing the command byte. Any bytes received after the command byte are data bytes. The first data



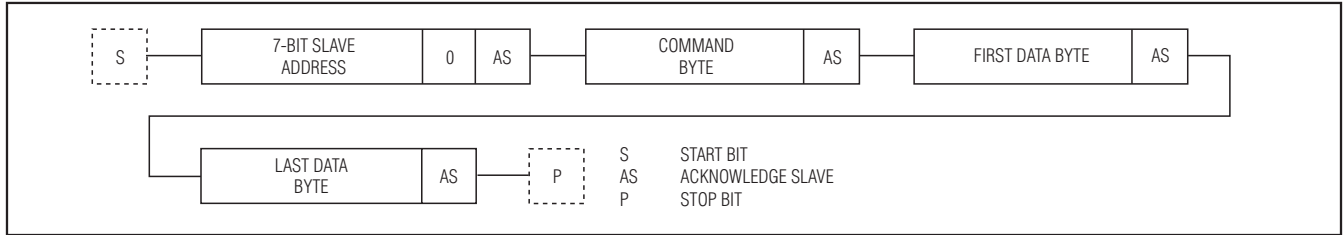

Figure 11. I<sup>2</sup>C Multiple-Byte Write

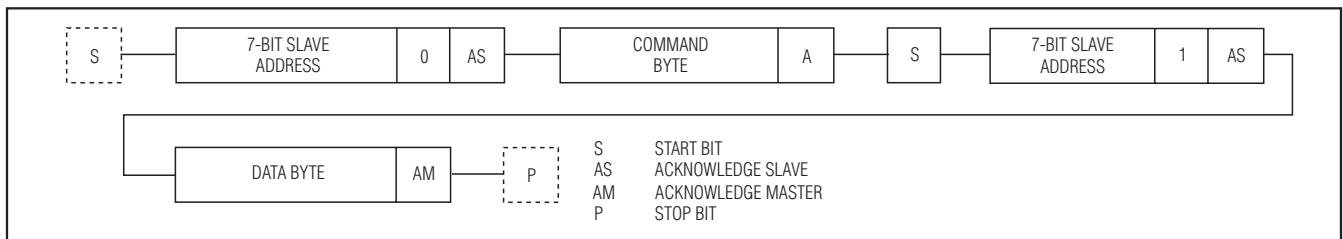

Figure 12. I<sup>2</sup>C Single-Byte Read

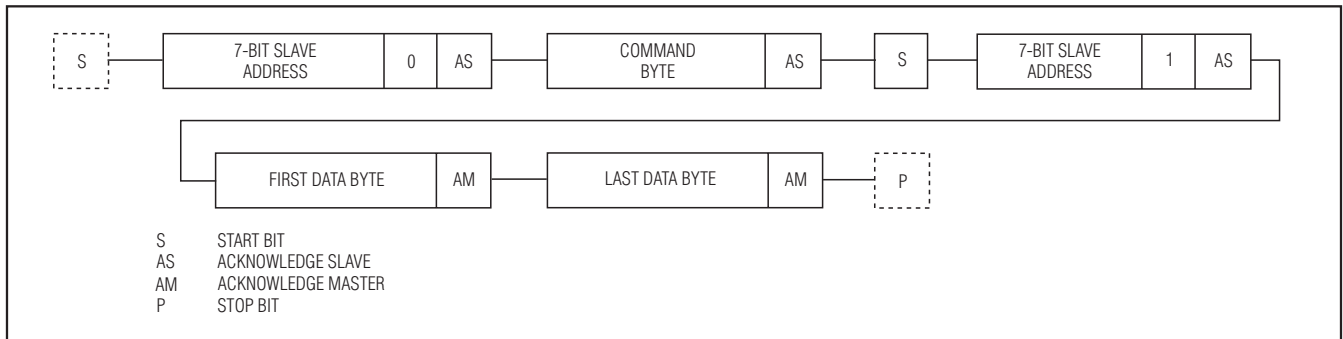

Figure 13. I<sup>2</sup>C Multiple-Byte Read

byte goes into the internal register of the MAX8831 selected by the command byte. If multiple data bytes are transmitted before a STOP condition is detected, these bytes are stored in subsequent MAX8831 internal registers because the command byte address auto-increments (Figure 11).

### Message Format for Reading

The MAX8831 is read using the MAX8831's internally stored command byte as an address pointer, the same way the stored command byte is used as an address pointer for a write. The pointer autoincrements after each data byte is read, using the same rules as for a write. Thus, a read is initiated by first configuring the MAX8831's command byte by writing the command byte corresponding to the beginning register address to be read. The master can now read n consecutive

bytes from the MAX8831, by first writing the read command (0x9B) to the MAX8831 (Figures 12 and 13). When performing read-after-write verification, reset the command byte's address since the stored byte address is autoincremented after the write.

### MAX8831 I<sup>2</sup>C Registers

The MAX8831 contains 19 registers that are accessible through the I<sup>2</sup>C interface (Table 3). See the register descriptions for more details. The register contents are reset to the default RESET values (shown in Table 3) if V<sub>DD</sub> goes low.

### ON/OFF Control Register

The ON/OFF control register (ON/OFF\_CNTL) enables and disables the LED1–LED5 current regulators (Table 4). Write a 1 to the LED#\_EN bit to enable that

LED\_ current regulator. Write a 0 to the LED#\_EN bit to disable that LED\_ current regulator. Overvoltage, open Schottky diode, and thermal-shutdown faults automatically clear all LED#\_EN bits to turn off all LED current regulators.

### LED\_Ramp Control Registers

The LED\_ ramp control registers (LED1\_RAMP\_CNTL to LED5\_RAMP\_CNTL) contains the timing information for each LED current regulator's ramp-up and ramp-down rate. The registers at locations 0x03 to 0x07 program the ramp rates of the LED1 to LED5 current regulators, respectively. The ramp-up and ramp-down rates are programmable with eight different timing selections. See Table 5.

### LED\_Current Control Registers

The LED\_ current control registers (ILED1\_CNTL to ILED5\_CNTL) program the individual LED1 to LED5 current regulators (see Tables 1 and 2 for programmable values). Registers located at 0x0B and 0x0C program the current of the LED1 and LED2 current regulators (Table 6). Registers located at 0x0D, 0x0E, and 0x0F program the current of the LED3, LED4, and LED5 current regulators, respectively (Table 7).

### LED3, LED4, and LED5 Blink Control Registers

The blink control registers (LED3\_BLINK\_CNTL to LED5\_BLINK\_CNTL) contain the blink control timing data for the LED3, LED4, and LED5 current regulators. The registers allow enabling of the blink function and control the on- and off-time of the blink sequence. The registers located at 0x17, 0x18, and 0x19 control the blink timing of the LED3, LED4, and LED5 current regulators, respectively. See Table 8. The LED1 and LED2 current regulators do not have blink functionality.

### Boost Control Register

The boost control register (BOOST\_CNTL) determines if the LED3, LED4, or LED5 current regulators are included in the step-up converter regulation loop. If programmed to be powered from the step-up converter, LED\_ is included in the feedback loop. Otherwise, if LED\_ is programmed to be powered from an alternate source, LED\_ is not included in the feedback loop. LED3, LED4, and LED5 are high impedance in shutdown. If the BOOST\_CNTL bits are programmed to power LED3, LED4, or LED5 from an alternate source, open LED detection is enabled only for that current regulator. See Table 9. The LED1 and LED2 inputs are always in the feedback loop and are not programmable with the boost control register.

### LED\_Status Registers

The LED\_ status registers (STAT1, STAT2) indicate the fault conditions of the MAX8831 IC and LEDs and are read-only registers. The STAT1 register indicates a fault condition for each LED\_ string, whether a shorted or open LED\_ fault is causing the fault condition. The second status register, STAT2, reports the following global system faults: output overvoltage-condition detection (OVP), thermal-shutdown condition detection (TSD), and open Schottky diode detection (OSDD). See Tables 10 and 11. See the *Open/Shorted LED Detection*, *Output Overvoltage Protection*, *Open Schottky Diode Detection*, *Thermal-Shutdown Protection*, and *System States and Fault Handling* sections for more details.

### Chip ID

The CHIP ID registers (CHIP\_ID1 and CHIP\_ID2) contains MAX8831 die type and mask revision data. These registers are read-only registers. See Tables 12 and 13.

## Applications Information

### Inductor Selection

The MAX8831 is optimized for a 10μH inductor, although larger or smaller inductors can be used. Using a smaller inductor results in discontinuous current-mode operation over a larger range of output power, whereas use of a larger inductor results in continuous conduction for most of the operating range.

To prevent core saturation, ensure that the inductor's saturation current rating exceeds the peak inductor current for the application. For larger inductor values and continuous conduction operation, calculate the worst-case peak inductor current with the following formula:

$$I_{PEAK} = \frac{V_{OUT} \times I_{OUT(MAX)}}{0.9 \times V_{IN(MIN)}} + \frac{V_{IN(MIN)} \times 0.5\mu s}{2 \times L}$$

Otherwise, for small values of L in discontinuous conduction operation, I<sub>PEAK</sub> is 860mA (typ). Table 14 provides a list of recommended inductors.

### Capacitor Selection

Ceramic X5R or X7R dielectric capacitors are recommended for best operation. When selecting ceramic capacitors in the smallest available case size for a given value, ensure that the capacitance does not degrade significantly with DC bias. Generally, ceramic capacitors with high values and very small case size have poor DC bias characteristics.

The typical value for the input capacitor is 1μF, and the typical value for the output capacitor is 1μF. Higher value capacitors can reduce input and output ripple, but at the expense of size and higher cost.

### Diode Selection

The high switching frequency of the MAX8831 demands a high-speed rectification diode for optimum efficiency. A Schottky diode is recommended due to its fast recovery time and low forward voltage drop. Ensure that the diode's average and peak current rating exceeds the average output current and peak inductor current. In addition, the diode's reverse breakdown voltage must exceed V<sub>OUT</sub>.

### Compensation Network Selection

The step-up converter is compensated for stability through an external compensation network from COMP to GND. The compensation capacitor is typically 0.22μF for most applications. Note that higher C<sub>COMP</sub> values increase soft-start duration, as well as the time delay between enabling the step-up converter to initiating soft-start.

### Combining BLINK Timer and RAMP Functions

When using the ramp functionality of LED3, LED4, and LED5 in combination with the blink timer, it is recommended to keep the ramp-up timer shorter than the blink ON timer and the ramp-down timer shorter than the blink OFF timer. See Figure 14. Failing to comply with this restriction results in LED<sub>1</sub> current not reaching maximum value during blink ON time, and LED<sub>1</sub> current

not returning to minimum current before turning off during the blink OFF time. The blink ON and blink OFF timers (t<sub>ON\_BLINK</sub> and t<sub>OFF\_BLINK</sub>) are programmed according to the following equations as guidance:

$$t_{\text{ON\_BLINK}} \geq \frac{t_{\text{LED\_RU}}}{32} (\text{LED\_CODE} + 1)$$

$$t_{\text{OFF\_BLINK}} \geq \frac{t_{\text{LED\_RD}}}{32} (\text{LED\_CODE} + 1)$$

Where t<sub>LED\_RU</sub> is the LED<sub>1</sub> ramp-up time, t<sub>LED\_RD</sub> is the LED<sub>1</sub> ramp-down time, and LED<sub>1</sub> is the decimal equivalent of the ILED<sub>1</sub>\_CNTL register value of Table 2.

### Using the LED3, LED4, and LED5 BOOST\_CNTRL Bit

The default setting of the BOOST\_CNTRL bits (low) include the LED3, LED4, and LED5 current regulators in the step-up converter minimum voltage select feedback circuit. This is intended for multi-LED strings powered from the step-up converter. For single LED indicator lights, set the respective BOOST\_CNTRL bit high, connect the LED anode to the battery or other voltage source, and connect the LED cathode to the respective LED<sub>1</sub> input. Ensure the voltage source is high enough to satisfy V<sub>F</sub> of the LED plus 150mV (current regulator dropout voltage). If BOOST\_CNTRL bits are set to high for LED3, LED4, and LED5 and LED1 and LED2 are not enabled, the step-up converter does not turn on when LED3, LED4, or LED5 is enabled.

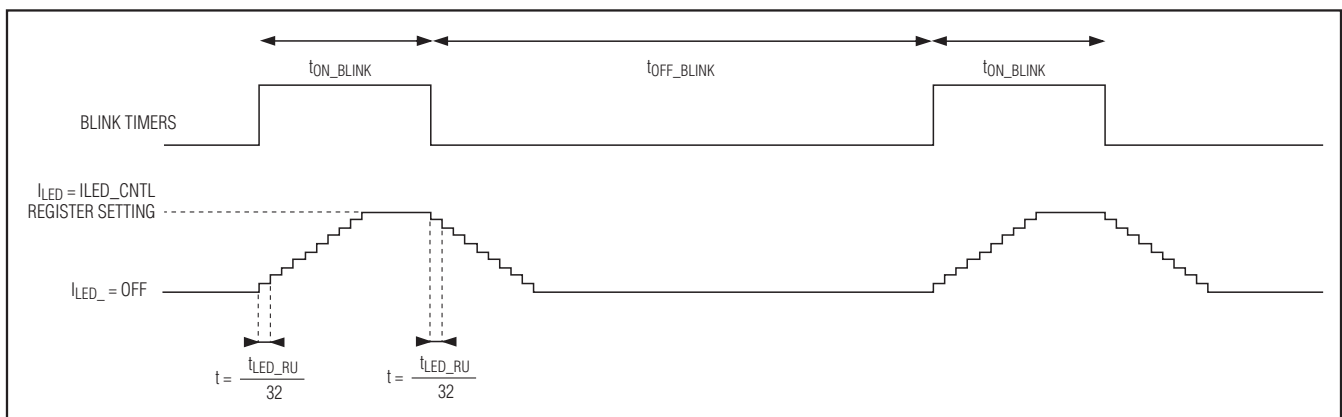

Figure 14. Combined Timing Characteristics of RAMP and BLINK Timers

**Table 3. MAX8831 Register Map**

REGISTER	COMMAND/ ADDRESS BYTE (HEX)	TYPE (READ/WRITE)	REGISTER RESET VALUES	FUNCTION
ON/OFF_CNTL	0x00	R/W	0x00	LED current regulator ON/OFF control
LED1_RAMP_CNTL	0x03	R/W	0x00	LED1 ramp control
LED2_RAMP_CNTL	0x04	R/W	0x00	LED2 ramp control
LED3_RAMP_CNTL	0x05	R/W	0x00	LED3 ramp control
LED4_RAMP_CNTL	0x06	R/W	0x00	LED4 ramp control
LED5_RAMP_CNTL	0x07	R/W	0x00	LED5 ramp control
ILED1_CNTL	0x0B	R/W	0x00	LED1 current sink control
ILED2_CNTL	0x0C	R/W	0x00	LED2 current sink control
ILED3_CNTL	0x0D	R/W	0x00	LED3 current sink control
ILED4_CNTL	0x0E	R/W	0x00	LED4 current sink control
ILED5_CNTL	0x0F	R/W	0x00	LED5 current sink control
LED3_BLINK_CNTL	0x17	R/W	0x00	LED3 blink rate control
LED4_BLINK_CNTL	0x18	R/W	0x00	LED4 blink rate control
LED5_BLINK_CNTL	0x19	R/W	0x00	LED5 blink rate control
BOOST_CNTL	0x1D	R/W	0x00	Adaptive step-up converter control
STAT1	0x2D	R	N/A	Status register1
STAT2	0x2E	R	N/A	Status register2
CHIP_ID1	0x39	R	0x07	Die type information
CHIP_ID2	0x3A	R	0x0B	Mask revision information

**Table 4. ON/OFF\_CNTL Register (Address 0x00)**

BIT	NAME	DESCRIPTION	BIT	NAME	DESCRIPTION
B7 (MSB)	—	Reserved for future use	B2	LED3_EN	0 = Disable LED3 current regulator 1 = Enable LED3 current regulator
B6	—	Reserved for future use	B1	LED2_EN	0 = Disable LED2 current regulator 1 = Enable LED2 current regulator
B5	—	Reserved for future use	B0 (LSB)	LED1_EN	0 = Disable LED1 current regulator 1 = Enable LED1 current regulator
B4	LED5_EN	0 = Disable LED5 current regulator 1 = Enable LED5 current regulator			
B3	LED4_EN	0 = Disable LED4 current regulator 1 = Enable LED4 current regulator			

**Table 5. LED#\_RAMP\_CNTL Registers (Addresses: 0x03, 0x04, 0x05, 0x06, 0x07)**

BIT	NAME	DESCRIPTION
B7 (MSB)	—	Reserved for future use
B6	—	Reserved for future use
B5	LED#_RAMP_DOWN [2:0]	Programs LED# current ramp-down rate using bits [5:3] as follows: 000 64ms 001 128ms 010 256ms 010 512ms 100 1024ms 101 2048ms 110 4096ms 111 8192ms
B4		
B3		
B2		
B1		
B0 (LSB)	LED#_RAMP_UP [2:0]	Sets LED# current ramp-up rate using bits [2:0] as follows: 000 64ms 001 128ms 010 256ms 010 512ms 100 1024ms 101 2048ms 110 4096ms 111 8192ms

#Indicates the selected LED current regulator (1, 2, 3, 4, or 5).

**Table 6. ILED#\_CNTL Registers for LED1 LED2 (Addresses: 0x0B, 0x0C)**

BIT	NAME	DESCRIPTION
B7 (MSB)	—	Reserved for future use
B6	ILED# [6:0]	Programs LED# current as indicated in Table 1
B5		
B4		
B3		
B2		
B1		
B0 (LSB)		

#Indicates selected LED current regulator (1 or 2).

**Table 7. ILED#\_CNTL Registers for LED3, LED4, LED5 (0x0D, 0x0E, 0x0F)**

BIT	NAME	DESCRIPTION
B7 (MSB)	—	Reserved for future use
B6	—	Reserved for future use
B5	—	Reserved for future use
B4	ILED# [4:0]	Programs LED# current as indicated in Table 2
B3		
B2		
B1		
B0 (LSB)		

#Indicates selected LED current regulator (3, 4, or 5).

**Table 8. LED#\_BLINK\_CNTL Registers (Addresses: 0x17, 0x18, 0x19)**

BIT	NAME	DESCRIPTION
B7 (MSB)	—	Reserved for future use
B6	LED#_BLINK_EN	0 LED# blink function disabled 1 LED# blink function enabled
B5	—	Reserved for future use
B4	LED#_TOFF_BLINK[1:0]	Programs LED# blink OFF timer using bits [4:3] as follows:
B3		00 LED# blink OFF timer set to 1024ms 01 LED# blink OFF timer set to 2048ms 10 LED# blink OFF timer set to 4096ms 11 LED# blink OFF timer set to 8192ms
B2		—
B1		Reserved for future use
B0 (LSB)	LED#_TON_BLINK[1:0]	Programs LED# blink ON timer using bits [1:0] as follows: 00 LED# blink ON timer set to 256ms 01 LED# blink ON timer set to 512ms 10 LED# blink ON timer set to 1024ms 11 LED# blink ON timer set to 2048ms

#Indicates selected LED current regulator (3, 4, or 5).

**Table 9. BOOST\_CNTL Register  
(Address: 0x1D)**

BIT	NAME	DESCRIPTION
B7 (MSB)	—	Reserved for future use
B6	—	Reserved for future use
B5	—	Reserved for future use
B4	LED5_BOOST_CNTL	0 = LED5 is powered from high-voltage STEP-UP converter. 1 = LED5 is powered from an alternate power source. V <sub>LED5</sub> is not used as an input for the feedback loop.
B3	LED4_BOOST_CNTL	0 = LED4 is powered from high-voltage STEP-UP converter. 1 = LED4 is powered from an alternate power source. V <sub>LED4</sub> is not used as an input for the feedback loop.
B2	LED3_BOOST_CNTL	0 = LED3 is powered from high-voltage STEP-UP converter. 1 = LED3 is powered from an alternate power source. V <sub>LED3</sub> is not used as input for the feedback loop.
B1		Reserved for future use
B0 (LSB)		Reserved for future use

**Table 10. STAT1 Register  
(Address 0x2D)**

BIT	NAME	DESCRIPTION
B7 (MSB)	—	Reserved for future use
B6	—	Reserved for future use
B5	—	Reserved for future use
B4	LED5_FAULT	0 = No open or short is detected for LED5 1 = Open or short is detected for LED5
B3	LED4_FAULT	0 = No open or short is detected for LED4 1 = Open or short is detected for LED4
B2	LED3_FAULT	0 = No open or short is detected for LED3 1 = Open or short is detected for LED3
B1	LED2_FAULT	0 = No open or short is detected for LED2 1 = Open or short is detected for LED2
B0 (LSB)	LED1_FAULT	0 = No open or short is detected for LED1 1 = Open or short is detected for LED1

**Table 11. STAT2 Register (Address 0x2E)**

BIT	NAME	DESCRIPTION
B7 (MSB)		Reserved for future use
B6		Reserved for future use
B5		Reserved for future use
B4		Reserved for future use
B3		Reserved for future use
B2	OSDD	Open Schottky diode detection 0 = Schottky diode is present 1 = Schottky diode is missing
B1	TSD	Thermal-shutdown detection 0 = No thermal shutdown occurred 1 = MAX8831 has entered thermal shutdown since the last read operation of this register
B0 (LSB)	OVP	Output overvoltage detection 0 = No overvoltage protection has occurred 1 = MAX8831 has entered over voltage protection since last read operation of this register

**PCB Layout**

Due to fast switching waveforms and high current paths, careful PCB layout is required. Minimize trace lengths between the IC and the inductor, the diode, the input capacitor, and the output capacitor. Minimize trace lengths between the input and output capacitors and the MAX8831 GND terminal, and place input and output capacitor grounds as close together as possible. Use separate power ground and analog ground copper areas, and connect them together at the output capacitor ground. Keep traces short, direct, and wide. Keep noisy traces, such as the LX node trace, away from sensitive analog circuitry. For improved thermal performance, maximize the copper area of the LX and PGND traces. Refer to the MAX8831 EV Kit for an example layout.

**Table 12. CHIP\_ID1 Register (Address: 0x39)**

BIT	NAME	DESCRIPTION
B7 (MSB) B6 B5 B4	DIE_TYPE[7:4]	BCD character 0
B3 B2 B1 B0 (LSB)	DIE_TYPE[3:0]	BCD character 7

**Table 13. CHIP\_ID2 Register (Address 0x3A)**

BIT	NAME	DESCRIPTION
B7 (MSB) B6 B5 B4	DASH [7:4]	BCD character 0
B3 B2 B1 B0 (LSB)	MASK_REV [3:0]	BCD character B

**Table 14. Recommended Inductors for the MAX8831 Circuit**

PART	L (μH)	DCR (mΩ)	ISAT (A)	SIZE (mm)
TOKO 1098AS-100M	10	290	0.75	2.8 x 3.0 x 1.2
TOKO 1069AS-220M	22	570	0.47	3 x 3 x 1.8
FDK MIP3226D100M	10	160	0.9	3.2 x 2.6 x 1.0
Coilcraft EPL2014-472ML	4.7	231	650	2.0 x 2.0 x 1.45
Coilcraft DO2010-472ML	4.7	800	650	2.0 x 2.0 x 1.0



# MAX8831

## High-Efficiency, White LED Step-Up Converter with I<sup>2</sup>C Interface in 2mm x 2mm WLP

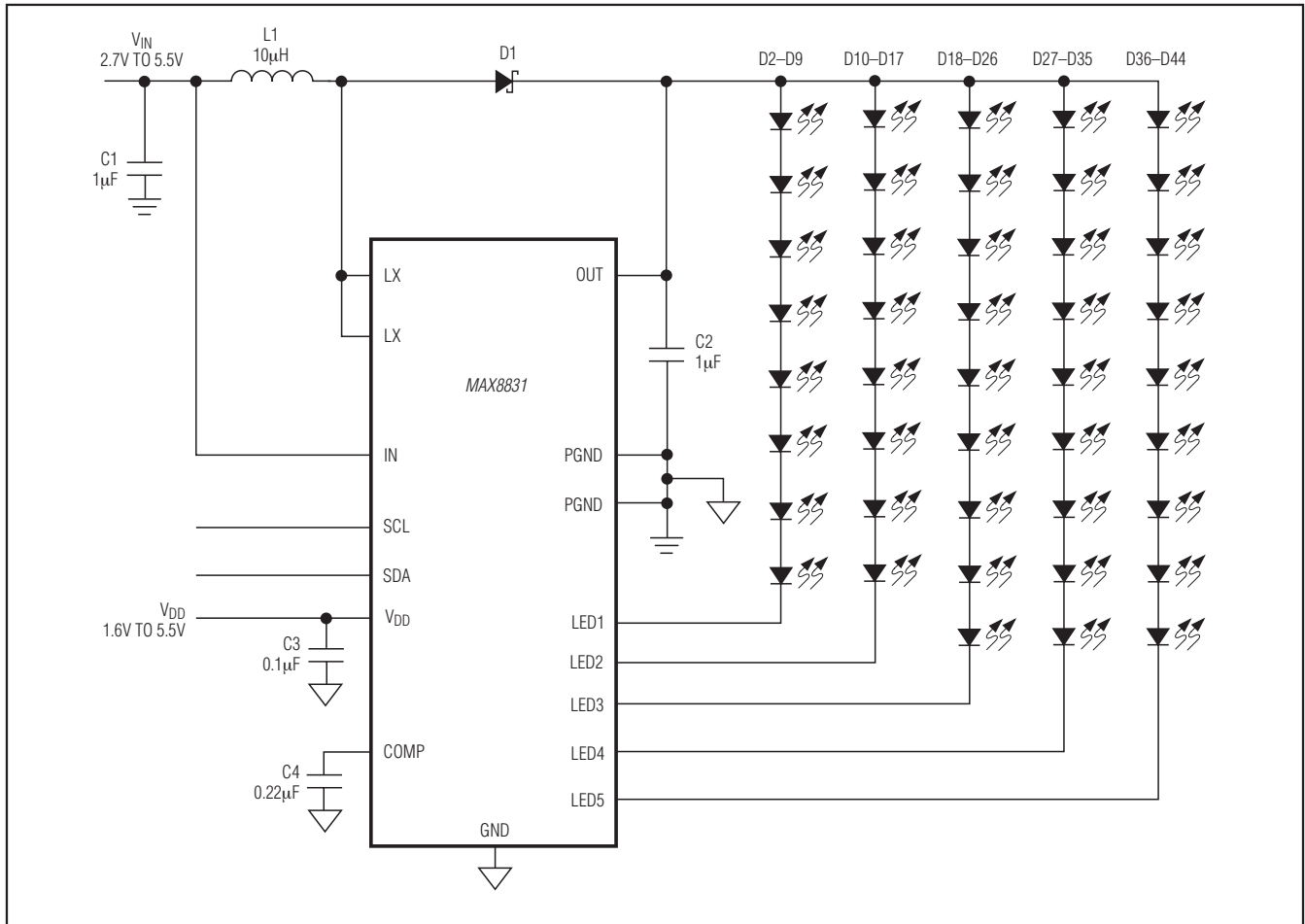
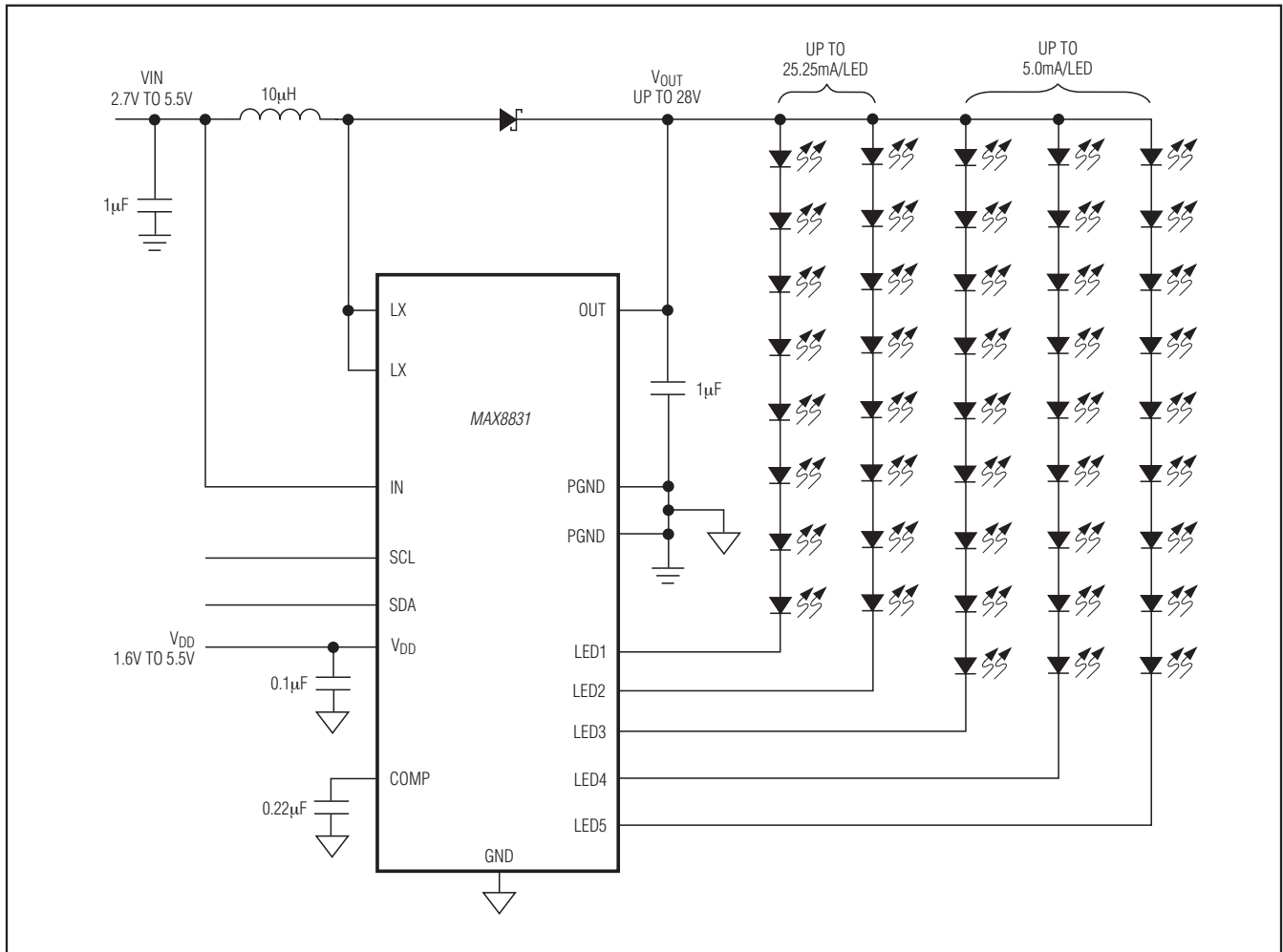

Figure 15. MAX8831 Applications Circuit

Typical Operating Circuit



Chip Information

PROCESS: BiCMOS

### Pin Configuration

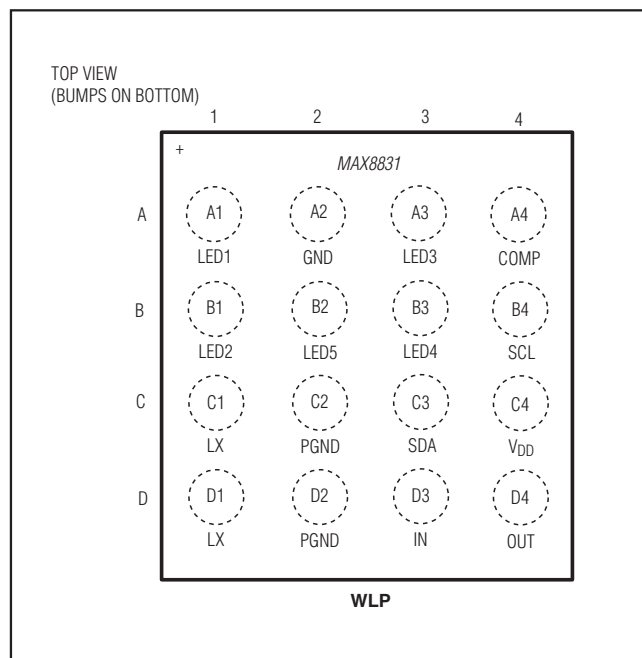

### Package Information

For the latest package outline information and land patterns (footprints), go to [www.maximintegrated.com/packages](http://www.maximintegrated.com/packages). Note that a "+", "#", or "-" in the package code indicates RoHS status only. Package drawings may show a different suffix character, but the drawing pertains to the package regardless of RoHS status.

PACKAGE TYPE	PACKAGE CODE	OUTLINE NO.
16 WLP	W162B2+1	<a href="#">21-0200</a>

## Revision History

REVISION NUMBER	REVISION DATE	DESCRIPTION	PAGES CHANGED
0	11/08	Initial release	—
1	7/09	Corrected shutdown current unit of measure	1
2	5/15	Updated <i>Benefits and Features</i> section	1

For pricing, delivery, and ordering information, please contact Maxim Direct at 1-888-629-4642, or visit Maxim Integrated's website at [www.maximintegrated.com](http://www.maximintegrated.com).

*Maxim Integrated cannot assume responsibility for use of any circuitry other than circuitry entirely embodied in a Maxim Integrated product. No circuit patent licenses are implied. Maxim Integrated reserves the right to change the circuitry and specifications without notice at any time. The parametric values (min and max limits) shown in the Electrical Characteristics table are guaranteed. Other parametric values quoted in this data sheet are provided for guidance.*

# Mouser Electronics

Authorized Distributor

Click to View Pricing, Inventory, Delivery & Lifecycle Information:

[Maxim Integrated:](#)

[MAX8831EWE+T](#)