



Fuse-link, high speed, 32 A, AC 690 V, DIN 000, 21 x 40 x 100 mm, gR, DIN, IEC, single indicator

Catalog No. 170M1362

Delivery program

Product range			Fuse
Basic function			Fuse-link
Field of application			high speed
Rated current	I	A	32
Rated voltage			AC 690 V
Construction size			DIN 000
Size			21 x 40 x 100 mm
Utilization category			gR
Status indicator			single indicator
Breaking Capacity		kA	200
usable for size/applications			semiconductor protection
Standard/Approval			DIN IEC
Shape			square body with offset bolted tags (slotted)
Standards/Regulations			DIN 43653 IEC 60269-4

Technical data ETIM 7.0

Circuit breakers and fuses (EG000020) / Low Voltage HRC fuse (EC000055)			
Electric engineering, automation, process control engineering / Electrical installation, device / Safety fuse inserts / Low-Voltage HRC fuse (ecl@ss10.0.1-27-14-20-05 [AFZ800015])			
Construction size			Other
Rated current		A	32
Rated voltage		V	690
Voltage type			AC
Rated switching capacity		kA	200
Utilization category			gR (general purpose semiconductor protection)
Type of fuse status indicator			Top fuse status indicator
Insulated metal gripping lugs (IMGL)			No

Approvals

Product Standards			IEC/EN 60269-4; UL 248-1; CSA-C22.2 No. 248.14; CE marking
UL File No.			E125085
UL Category Control No.			JFHR2
CSA File No.			053787_C_000
CSA Class No.			1422-30
North America Certification			UL recognized, CSA certified
Suitable for			semiconductor protection

Dimensions

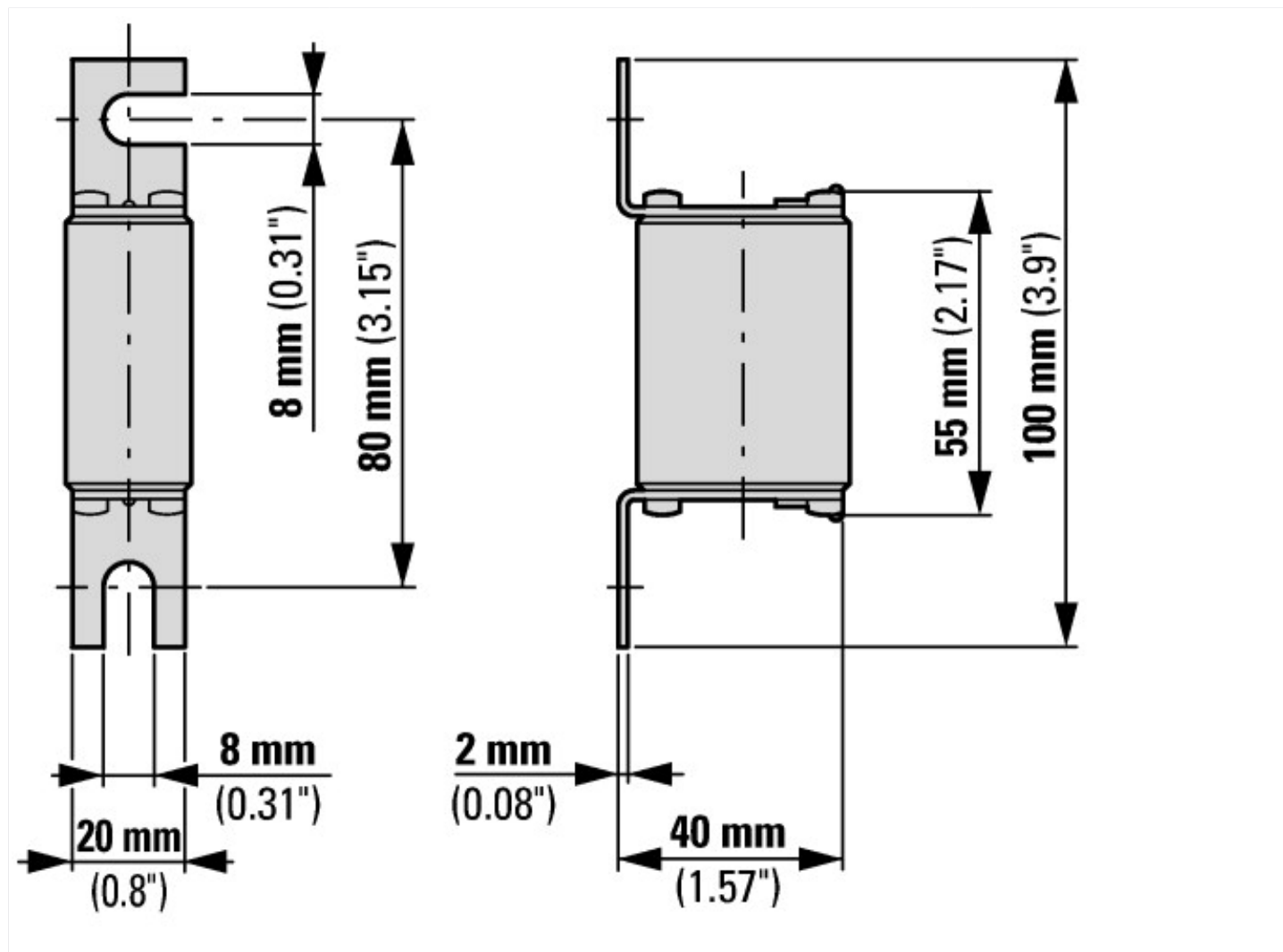

Additional product information (links)

Product datasheet (pdf)

http://www.cooperindustries.com/content/dam/public/bussmann/Electrical/Resources/product-datasheets-b/Bus_Ele_DS_720013_170M.pdf