

Click to view price, real time Inventory,  
Delivery & Lifecycle Information ;

# HMC985ALP4KE

Analog Devices

Attenuators Attenuators

Any questions, please feel free to contact us.

[info@kaimte.com](mailto:info@kaimte.com)

## GaAs MMIC VOLTAGE - VARIABLE ATTENUATOR, 10 - 40 GHz

### Typical Applications

The HMC985ALP4KE is ideal for:

- Point-to-Point Radio
- VSAT Radio
- Test Instrumentation
- Microwave Sensors
- Military, ECM & Radar

### Functional Diagram

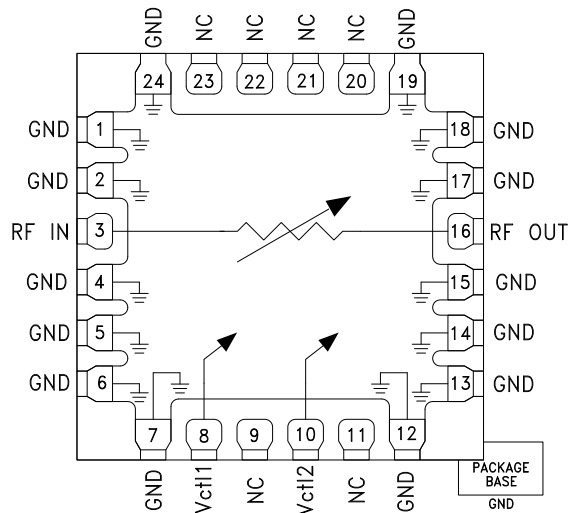

### Features

- Wide Bandwidth: 10 - 40 GHz
- Excellent Linearity: +32 dB Input IP3
- Wide Attenuation Range: 35 dB
- No External Matching
- 24 Lead 4x4 mm SMT Package: 16 mm<sup>2</sup>

### General Description

The HMC985ALP4KE is an absorptive Voltage Variable Attenuator (VVA) which operates from 10 - 40 GHz and is ideal in designs where an analog DC control signal must be used to control RF signal levels over a 35 dB dynamic range. It features two shunt-type attenuators which are controlled by two analog voltages, Vctl1 and Vctl2. Optimum linearity performance of the attenuator is achieved by first varying Vctl1 of the first attenuation stage from -5V to 0V with Vctl2 fixed at -5V. The control voltage of the second attenuation stage, Vctl2, should then be varied from -5V to 0V with Vctl1 fixed at 0V.

If the Vctl1 and Vctl2 pins are connected together it is possible to achieve the full analog attenuation range with only a small degradation in input IP3 performance. Applications include AGC circuits and temperature compensation of multiple gain stages in microwave point-to-point and VSAT radios.

### Electrical Specifications, $T_A = +25^\circ\text{C}$ , Test Condition $V_{ctl1} = V_{ctl2}$

| Parameter   | Frequency   | Min. | Typ. | Max. | Units |
|---|-------------|------|------|------|-------|
| Insertion Loss <sup>[1]</sup>   | 10 - 20 GHz |      | 3.1  | 3.9  | dB    |
|   | 20 - 30 GHz |      | 2.1  | 3.5  | dB    |
|   | 30 - 40 GHz |      | 2.9  | 4.0  | dB    |
| Attenuation Range   | 10 - 20 GHz | 25   | 30   |      | dB    |
|   | 20 - 30 GHz | 30   | 39   |      | dB    |
|   | 30 - 40 GHz | 35   | 42   |      | dB    |
| Input Return Loss   | 10 - 40 GHz |      | 13   |      | dB    |
| Output Return Loss  | 10 - 40 GHz |      | 13   |      | dB    |
| Input Third Order Intercept<br>(two-tone input Power = 10 dBm Each Tone) <sup>[2]</sup> |             |      | 32   |      | dBm   |

[1] Vctl1 = Vctl2 = -4V

[2] Vctl1 = Vctl2 = -3.4V worst case

Information furnished by Analog Devices is believed to be accurate and reliable. However, no responsibility is assumed by Analog Devices for its use, nor for any infringements of patents or other rights of third parties that may result from its use. Specifications subject to change without notice. No license is granted by implication or otherwise under any patent or patent rights of Analog Devices. Trademarks and registered trademarks are the property of their respective owners.

For price, delivery, and to place orders: Analog Devices, Inc., One Technology Way, P.O. Box 9106, Norwood, MA 02062-9106 Phone: 781-329-4700 • Order online at [www.analog.com](http://www.analog.com) Application Support: Phone: 1-800-ANALOG-D

**GaAs MMIC VOLTAGE - VARIABLE ATTENUATOR, 10 - 40 GHz**

**Attenuation vs. Frequency over Vctl1 = Variable, Vctl2 = -5V**

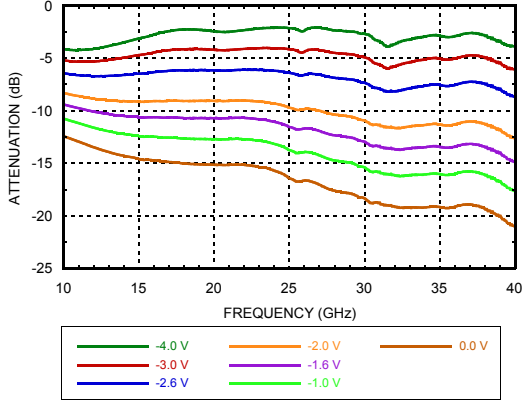

**Attenuation vs. Frequency over Vctl1 = 0V, Vctl2 = Variable**

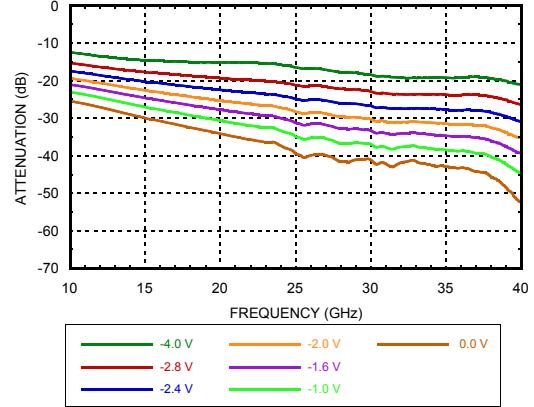

**Attenuation vs. Vctl1 Over Temperature @ 25 GHz, Vctl2 = -5V**

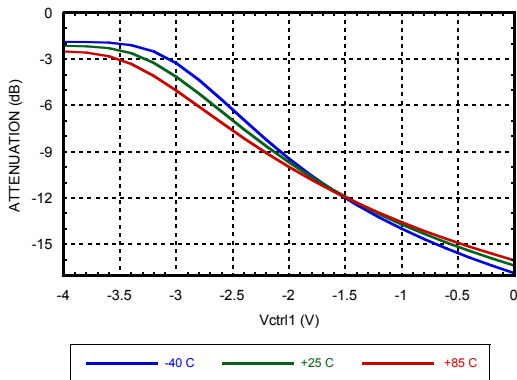

**Attenuation vs. Vctl2 Over Temperature @ 30 GHz, Vctl1 = 0V**

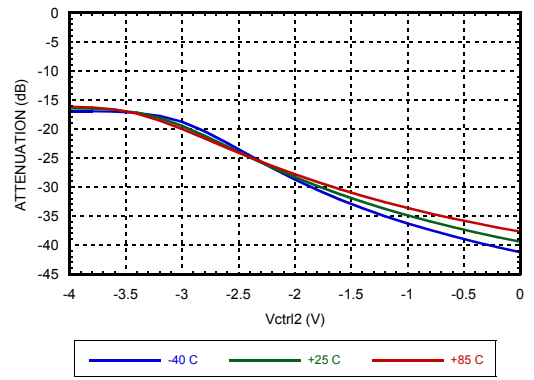

**Attenuation vs. Pin @ 20 GHz over Vctl1 Vctl1 = Variable, Vctl2 = -3V**

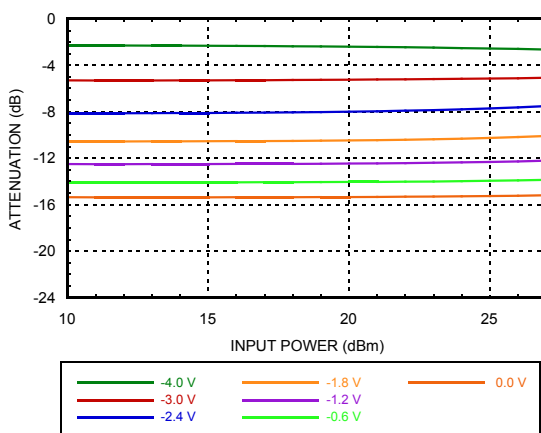

**Attenuation vs. Pin @ 20 GHz over Vctl2 Vctl2 = Variable, Vctl1 = 0V**

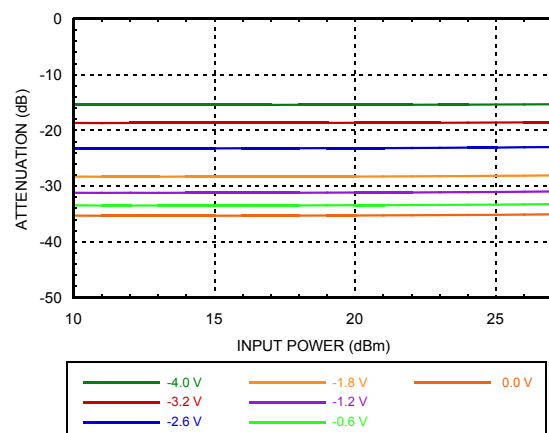

**GaAs MMIC VOLTAGE - VARIABLE ATTENUATOR, 10 - 40 GHz**

**Input Return Loss**  
Vctl1 = Variable, Vctl2 = -5V

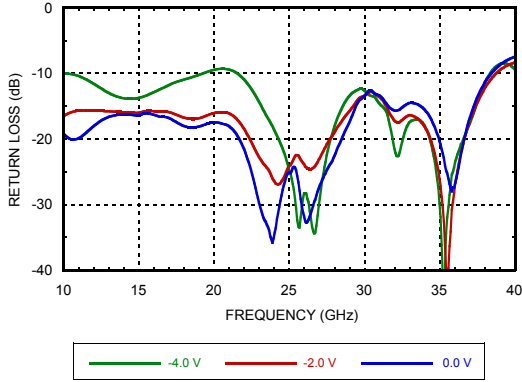

**Input Return Loss**  
Vctl1 = 0V, Vctl2 = Variable

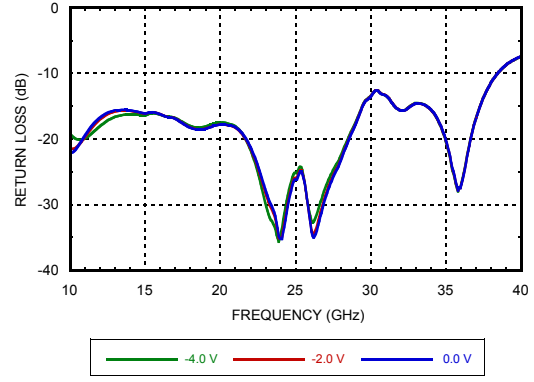

**Output Return Loss**  
Vctl1 = Variable, Vctl2 = -5V

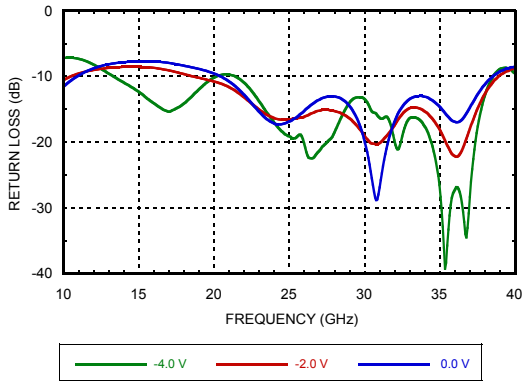

**Output Return Loss**  
Vctl1 = 0V, Vctl2 = Variable

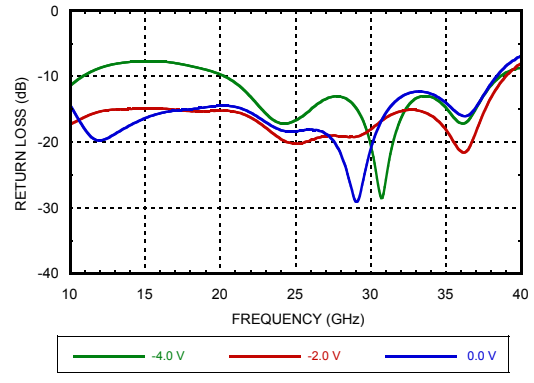

**Input IP3 vs. Input Power @ 20 GHz**  
Vctl1 = Variable, Vctl2 = -5V

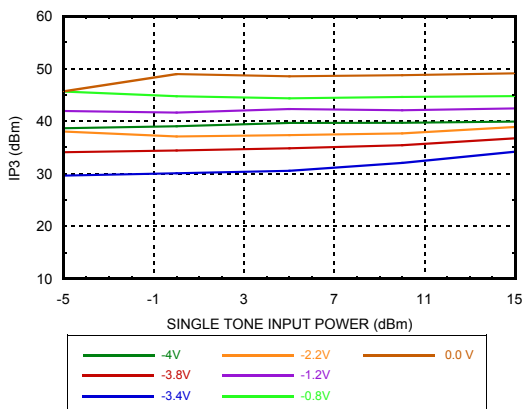

**Input IP3 vs. Input Power Over Frequency**  
Vctl1 = -3.2V, Vctl2 = -5V [1]

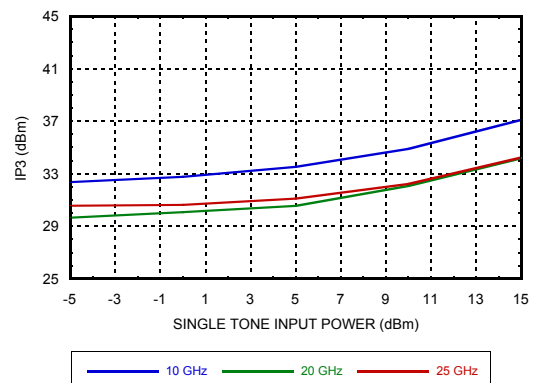

[1] Worst Case IP3

**GaAs MMIC VOLTAGE - VARIABLE ATTENUATOR, 10 - 40 GHz**

**Input IP3 vs. Input Power Over Temperature @ 20 GHz, Vctl1 = -3.4V, Vctl2 = -5V [1]**

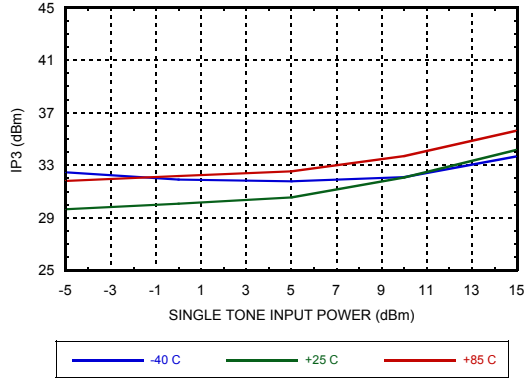

**Input IP3 vs. Input Power @ 20 GHz Vctl2 = Variable, Vctl1 = 0V**

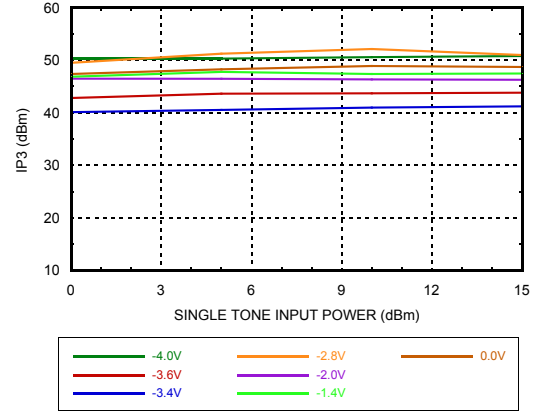

**Input IP3 vs. Input Power Over Frequency Vctl2 = -3.4V, Vctl1 = 0V [1]**

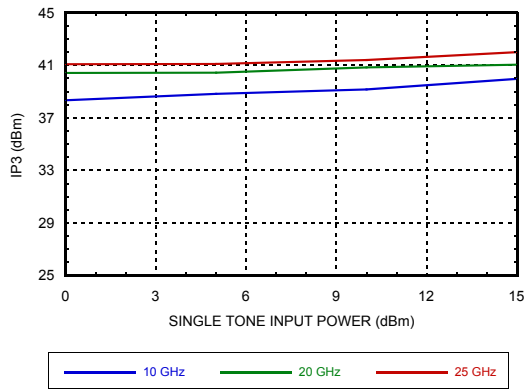

**Input IP3 vs Input Power over Temperature @ 20 GHz, Vctl2 = -3.4V, Vctl1 = 0V [1]**

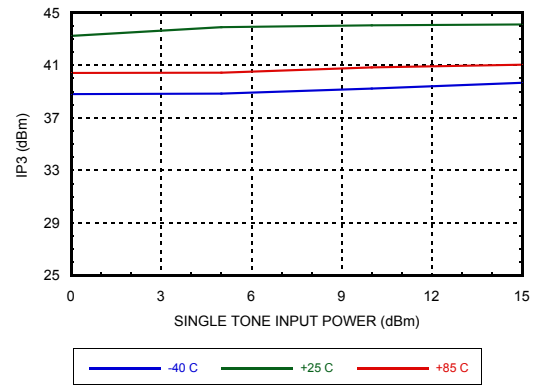

[1] Worst Case IP3

**GaAs MMIC VOLTAGE - VARIABLE ATTENUATOR, 10 - 40 GHz**

**Attenuation vs Frequency Over Vctrl**  
Vctrl1 = Vctrl2

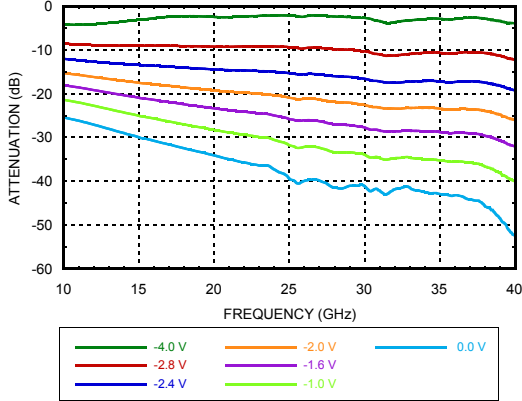

**Attenuation vs. Vctrl Over Temperature**  
@ 20 GHz, Vctrl1 = Vctrl2

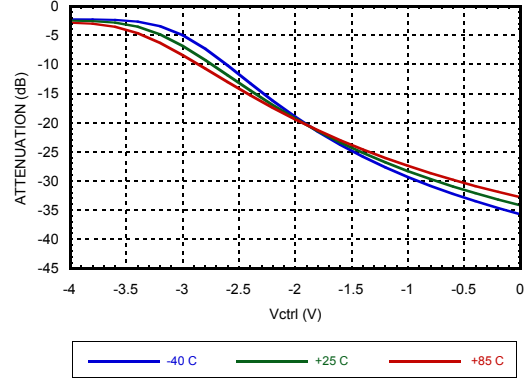

**Attenuation vs. Pin @ 20 GHz Over Vctrl**  
Vctrl1 = Vctrl2

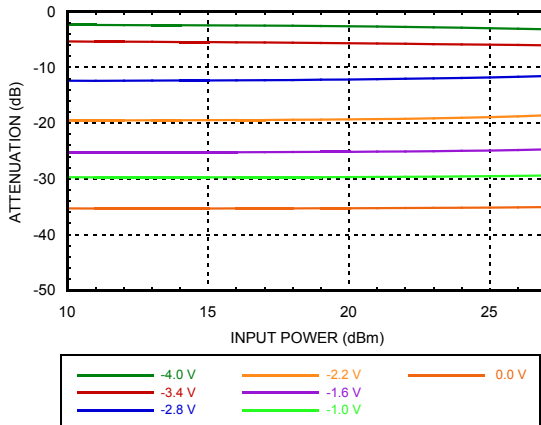

**Input Return Loss, Vctrl1 = Vctrl2**

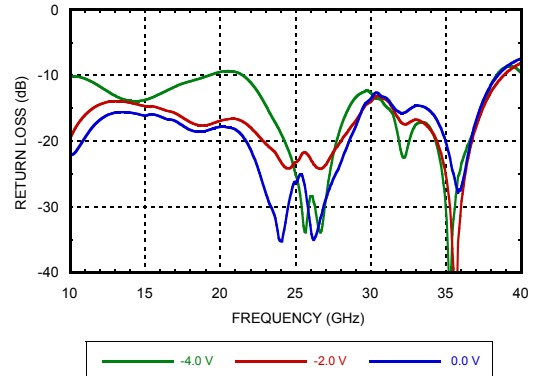

**Output Return Loss, Vctrl1 = Vctrl2**

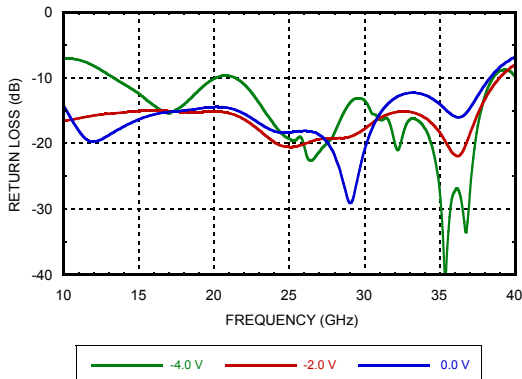

**Input IP3 vs. Input Power Over Vctrl @ 20 GHz, Vctrl1 = Vctrl2**

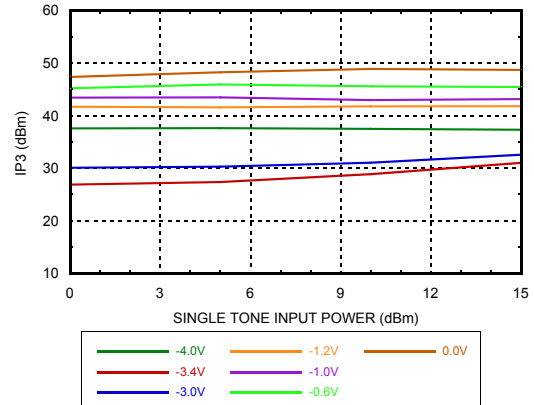

**GaAs MMIC VOLTAGE - VARIABLE  
ATTENUATOR, 10 - 40 GHz**

**Input IP3 vs. Input Power Over Frequency**  
Vctl1 = Vctl2

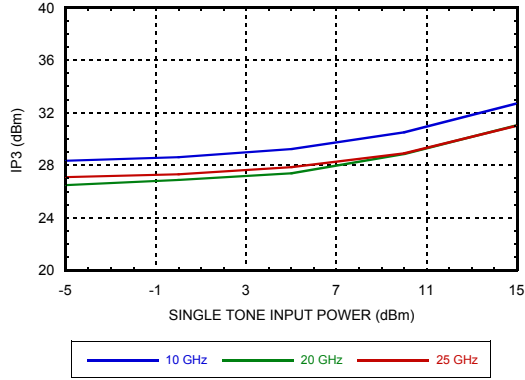

**Input IP3 vs. Input Power Over Temperature @ 20 GHz**  
Vctl1 = Vctl2

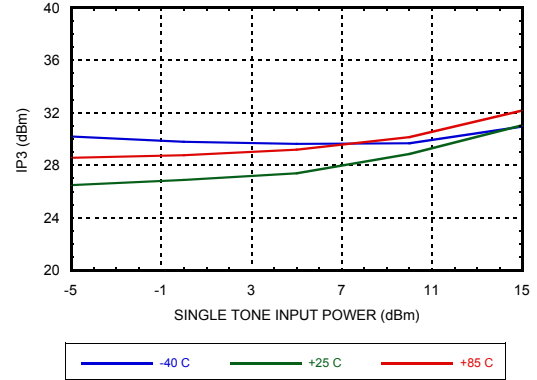

**GaAs MMIC VOLTAGE - VARIABLE  
ATTENUATOR, 10 - 40 GHz**
**Absolute Maximum Ratings**

|  |                |
|--|----------------|
| Control Voltage  | +0.3 to -6.0V  |
| Input RF Power   | 30 dBm         |
| Maximum Junction Temperature   | 175 °C         |
| Thermal Resistance (R <sub>TH</sub> )<br>(junction to ground paddle) | 65 °C/W        |
| Operating Temperature  | -40°C to +85°C |
| Storage Temperature  | -65°C to 150°C |
| ESD Sensitivity (HBM)  | Class1B        |

**Control Voltages**

|            |                           |
|------------|---------------------------|
| Vctrl1 [1] | -5V to 0V @ 10uA, typical |
| Vctrl2 [1] | -5V to 0V @ 10uA, typical |

[1] Vctrl1 = Vctrl2 = -4.0V

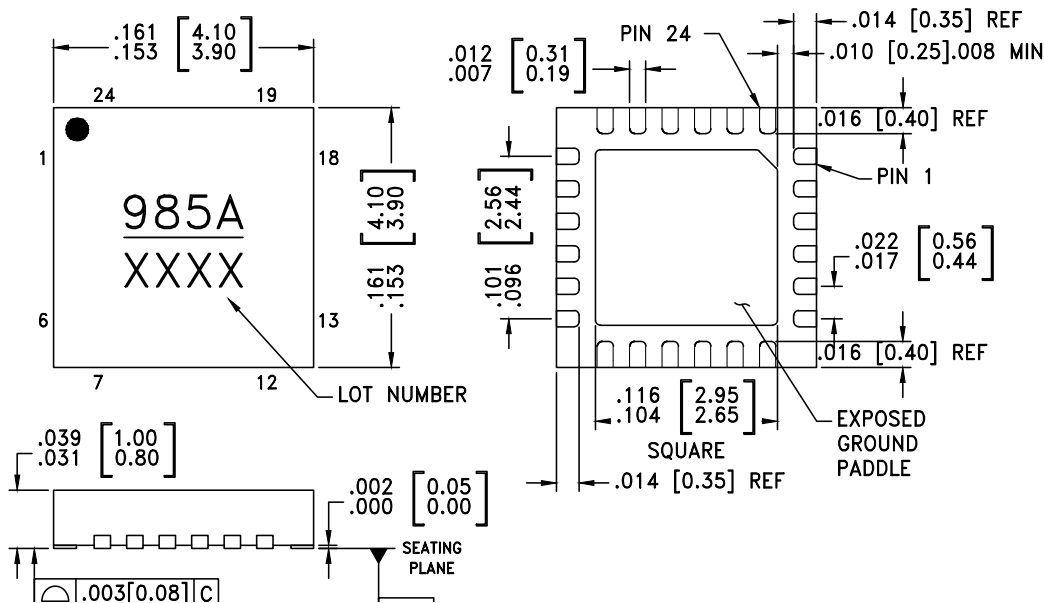
**ELECTROSTATIC SENSITIVE DEVICE  
OBSERVE HANDLING PRECAUTIONS**
**Outline Drawing**

**NOTES:**

- PACKAGE BODY MATERIAL: LOW STRESS INJECTION MOLDED PLASTIC SILICA AND SILICON IMPREGNATED.
- LEAD AND GROUND PADDLE MATERIAL: COPPER ALLOY.
- LEAD AND GROUND PADDLE PLATING: 100% MATTE TIN
- DIMENSIONS ARE IN INCHES [MILLIMETERS].
- LEAD SPACING TOLERANCE IS NON-CUMULATIVE.
- CHARACTERS TO BE HELVETICA MEDIUM, .025 HIGH, WHITE INK, OR LASER MARK LOCATED APPROX. AS SHOWN.
- PAD BURR LENGTH SHALL BE 0.15mm MAX. PAD BURR HEIGHT SHALL BE 0.05mm MAX.
- PACKAGE WARP SHALL NOT EXCEED 0.05mm
- ALL GROUND LEADS AND GROUND PADDLE MUST BE SOLDERED TO PCB RF GROUND.
- REFER TO HITTITE APPLICATION NOTE FOR SUGGESTED PCB LAND PATTERN.

**Package Information**

| Part Number  | Package Body Material                              | Lead Finish   | MSL Rating | Package Marking |
|--------------|--|---------------|------------|-----------------|
| HMC985ALP4KE | RoHS-compliant Low Stress Injection Molded Plastic | 100% matte Sn | MSL3 [1]   | 985A<br>XXXX    |

[1] Max peak reflow temperature of 260 °C

[2] 4-Digit lot number XXXX

For price, delivery, and to place orders: Analog Devices, Inc., One Technology Way, P.O. Box 9106, Norwood, MA 02062-9106  
 Phone: 781-329-4700 • Order online at [www.analog.com](http://www.analog.com)  
 Application Support: Phone: 1-800-ANALOG-D



## GaAs MMIC VOLTAGE - VARIABLE ATTENUATOR, 10 - 40 GHz

### Pin Descriptions

| Pin Number                  | Function | Description   | Pin Schematic |
|-----------------------------|----------|---|---------------|
| 1, 2, 4-7, 12-15, 17-19, 24 | GND      | These pins and package bottom must be connected to RF/DC ground externally.   |               |
| 3                           | RFIN     | This pad is DC coupled and matched to 50 Ohms.  |               |
| 8                           | Vctl1    | Control Voltage 1.  |               |
| 9, 11, 20-23                | NC       | These pins are not connected internally, however all data shown herein was measured with these pins connected to RF/DC ground externally. |               |
| 10                          | Vctl2    | Control Voltage 2.  |               |
| 16                          | RFOUT    | This pad is DC coupled and matched to 50 Ohms.  |               |

### Assembly Diagram

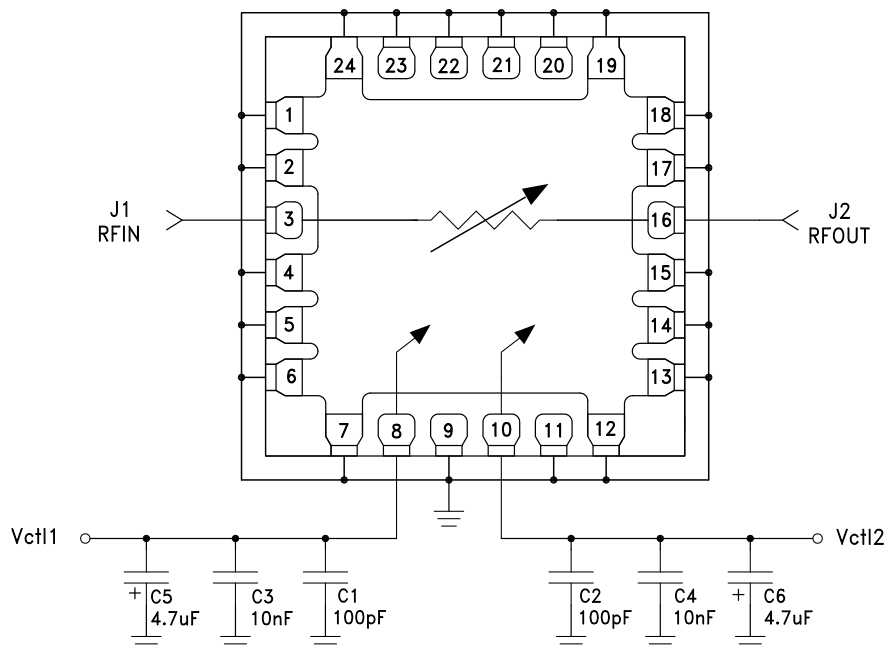

For price, delivery, and to place orders: Analog Devices, Inc., One Technology Way, P.O. Box 9106, Norwood, MA 02062-9106  
 Phone: 781-329-4700 • Order online at [www.analog.com](http://www.analog.com)  
 Application Support: Phone: 1-800-ANALOG-D

**GaAs MMIC VOLTAGE - VARIABLE  
ATTENUATOR, 10 - 40 GHz**

**Evaluation PCB**

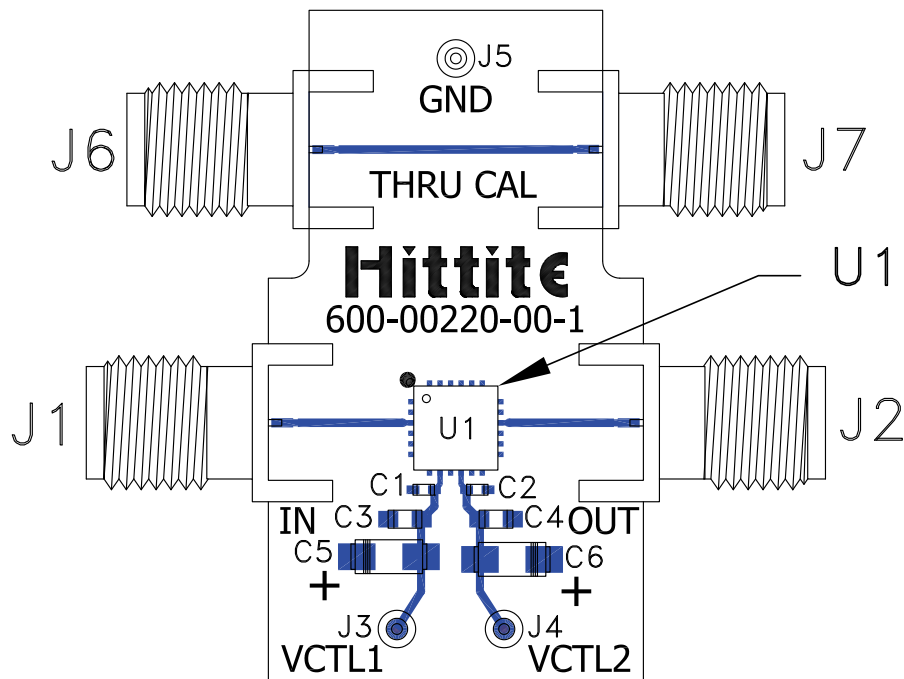

**List of Materials for Evaluation PCB EV1HMC985ALP4K [1]**

| Item         | Description                  |
|--------------|------------------------------|
| J1-J2, J6-J7 | K Connectors.                |
| J3-J5        | DC Pins.                     |
| C1-C2        | 100pF Capacitors, 0402 Pkg.  |
| C3-C4        | 0.01 μF Capacitor, 0603 Pkg. |
| C5-C6        | 4.7 μF Case A, Tantalum.     |
| U1           | HMC985ALP4KE VVA.            |
| PCB          | 600-00220-00 Evaluation PCB. |

[1] Reference this number when ordering complete evaluation PCB

The circuit board used in the final application should use RF circuit design techniques. Signal lines should have 50 Ohm impedance while the package ground leads and exposed paddle should be connected directly to the ground plane similar to that shown. A sufficient number of via holes should be used to connect the top and bottom ground planes. The evaluation circuit board shown is available from Analog Devices upon request.

**GaAs MMIC VOLTAGE - VARIABLE  
ATTENUATOR, 10 - 40 GHz****Notes:**

# Mouser Electronics

Authorized Distributor

Click to View Pricing, Inventory, Delivery & Lifecycle Information:

[Analog Devices Inc.:](#)

[HMC985ALP4KE](#) [HMC985ALP4KETR](#) [EV1HMC985ALP4K](#)