

Description

The AP7381 series is a positive voltage regulator IC.

The AP7381 has features of wide input voltage range, high accuracy, low dropout voltage, current limit and ultra-low quiescent current which make it ideal for use in various USB and portable devices.

The IC consists of a voltage reference, an error amplifier, a resistor network for setting output voltage, a current limit circuit for current protection, and a chip enable circuit.

The AP7381 has 2.8V, 3.3V, 5V and 7V fixed voltage version.

The AP7381 is available in space-saving SOT23, SOT89 and TO92 (Ammo Packing) packages.

Features

- Wide Input Voltage Range: Up to 40V
- Low Dropout Voltage: $V_{DROP} = 1000mV@I_{OUT} = 100mA@V_{OUT} = 3.3V$
- Low Ground Current
- High Output Voltage Accuracy
- Compatible with Low ESR Ceramic Capacitor
- Excellent Line/Load Regulation
- Thermal Shutdown Function
- Short Current Protection Function
- **Totally Lead-Free & Fully RoHS Compliant (Notes 1 & 2)**
- **Halogen and Antimony Free. "Green" Device (Note 3)**

Applications

- E-Meter
- Battery-powered Equipment
- Laptop, Palmtops, Notebook Computers
- Portable Information Appliances

- Notes:
1. No purposely added lead. Fully EU Directive 2002/95/EC (RoHS), 2011/65/EU (RoHS 2) & 2015/863/EU (RoHS 3) compliant.
 2. See <https://www.diodes.com/quality/lead-free/> for more information about Diodes Incorporated's definitions of Halogen- and Antimony-free, "Green" and Lead-free.
 3. Halogen- and Antimony-free "Green" products are defined as those which contain <900ppm bromine, <900ppm chlorine (<1500ppm total Br + Cl) and <1000ppm antimony compounds.

Pin Assignments

(Top View)

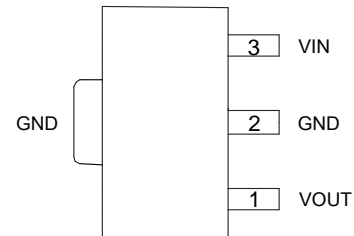

SOT89

(Top View)

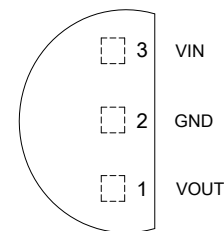

TO92 (Ammo Packing)

(Top View)

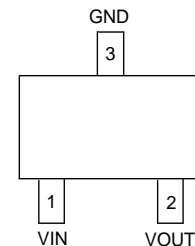

SOT23

Typical Applications Circuit

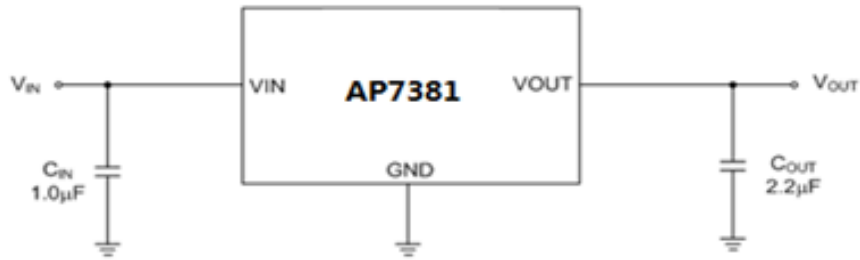

Pin Descriptions

Pin Number			Pin Name	Function
TO92 (Ammo Packing)	SOT89	SOT23		
3	3	1	VIN	Input voltage
2	2	3	GND	Ground
1	1	2	VOUT	Regulated output voltage

Absolute Maximum Ratings

Symbol	Parameter	Rating		Unit
V_{IN}	Supply Input Voltage	45		V
I_{OUT}	Output Current	150		mA
T_{LEAD}	Lead Temperature (Soldering, 10sec)	+260		°C
T_J	Operating Junction Temperature	+150		°C
θ_{JA}	Thermal Resistance	SOT89	125	°C/W
		TO92 (Ammo Packing)	165	
		SOT23	167	
T_{STG}	Storage Temperature Range	-65 to +150		°C
CDM	ESD (Change Device Model)	2000		V
HBM	ESD (Human Body Model)	4000		V

Recommended Operating Conditions

Symbol	Parameter	Min	Max	Unit
V_{IN}	Supply Input Voltage	3.3	40	V
T_J	Operating Junction Temperature	-40	+125	°C

Electrical Characteristics ($T_J = +25^\circ\text{C}$, $I_{OUT} = 1\text{mA}$, $C_{IN} = 1.0\mu\text{F}$, $C_{OUT} = 2.2\mu\text{F}$, $V_{IN} = V_{OUT} + 2\text{V}$, **Bold** typeface applies over $-40^\circ\text{C} \leq T_J \leq +125^\circ\text{C}$, unless otherwise specified.)

Symbol	Parameter	Test Conditions	Min	Typ	Max	Unit
V_{OUT}	Output Voltage	Variation from Specified V_{OUT}	$V_{OUT} \times 98\%$	—	$V_{OUT} \times 102\%$	V
V_{IN}	Input Voltage	—	3.3	—	40	V
I_{LIMIT}	Current Limit	$V_{OUT} = 98\% \times V_{OUT}, V_{IN} = V_{OUT} + 2\text{V}$	150	—	—	mA
$\Delta V_{OUT} / \Delta V_{IN}$	Line Regulation	$V_{OUT} + 2\text{V} \leq V_{IN} \leq 40\text{V}, I_{OUT} = 10\text{mA}$	—	0.05	—	%/V
$\Delta V_{OUT} / I_{OUT}$	Load Regulation	$1\text{mA} \leq I_{OUT} \leq 150\text{mA}$	—	0.5	—	%
V_{DROP}	Dropout Voltage	$I_{OUT} = 100\text{mA} @ V_{OUT} = 3.3\text{V}$	—	1000	—	mV
I_{GND}	Ground Current	$I_{OUT} = 0\text{A}$	—	2.5	—	μA
		$I_{OUT} = 100\text{mA}$	—	25	—	
$\Delta V_{OUT} / (V_{OUT} \Delta T)$	Output Voltage Temperature Coefficient	$I_{OUT} = 100\mu\text{A}, -40^\circ\text{C} \leq T_J \leq +125^\circ\text{C}$	—	± 100	—	ppm/ $^\circ\text{C}$
T_{OTSD}	Thermal Shutdown Temperature	—	—	+160	—	$^\circ\text{C}$
T_{HYOTSD}	Thermal Shutdown Hysteresis	—	—	+20	—	$^\circ\text{C}$
PSRR	Power Supply Rejection Ratio	$I_{OUT} = 1\text{mA}, V_{OUT} = 3.3\text{V}$	—	60	—	dB

Performance Characteristics

NEW PRODUCT

Output Voltage vs. Input Voltage @-40°C

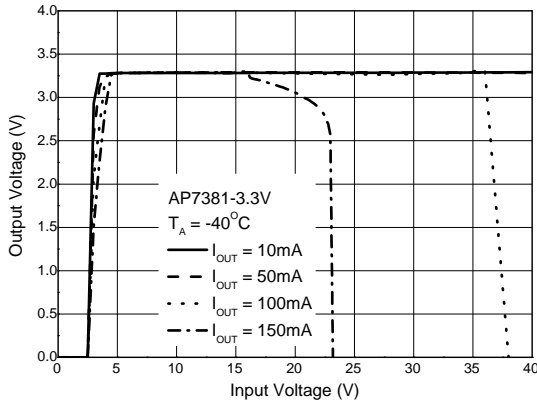

Output Voltage vs. Input Voltage @+25°C

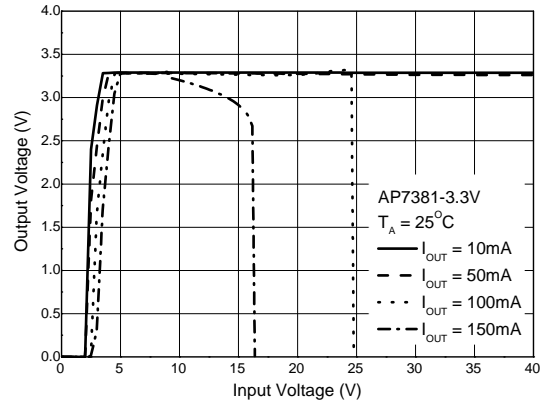

Output Voltage vs. Input Voltage @+85°C

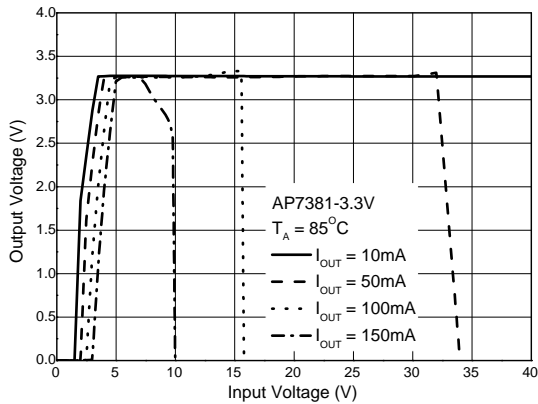

Output Voltage vs. Output Current

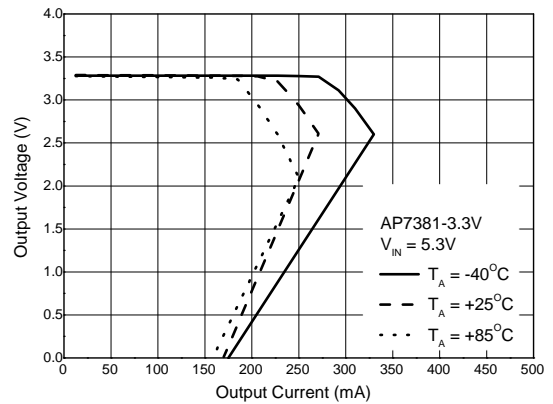

Output Voltage vs. Temperature

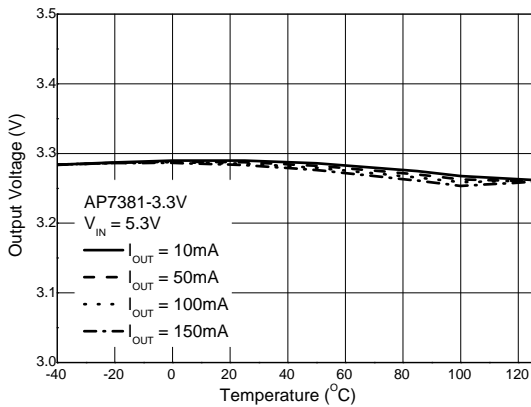

Output Voltage vs. Output Current

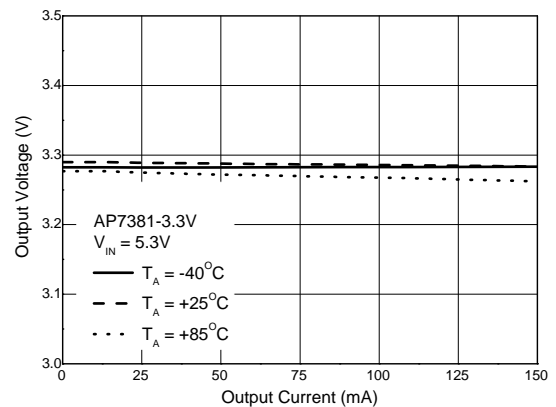

Performance Characteristics (Cont.)

Dropout Voltage vs. Output Current

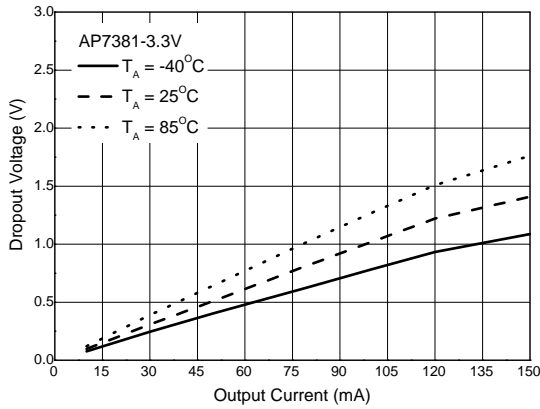

Dropout Voltage vs. Temperature

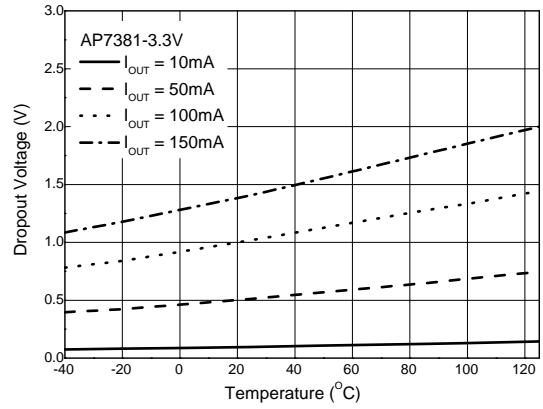

I_{GND} vs. Input Voltage

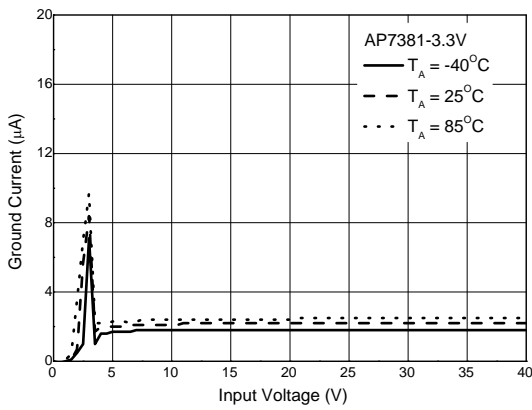

I_{GND} vs. Output Current

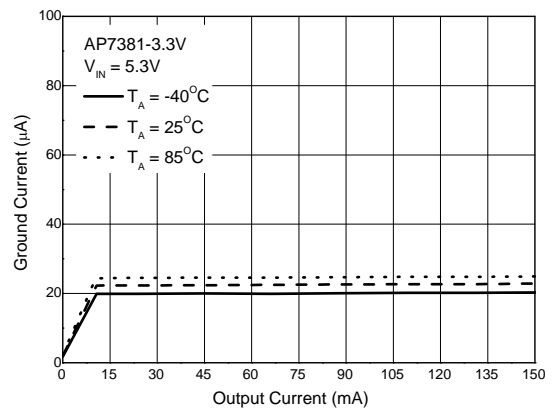

I_{GND} vs Temperature

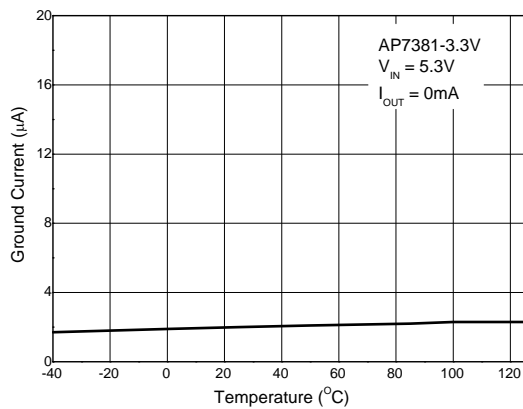

Load Transient
 $C_{IN} = 1\mu\text{F}$, $C_{OUT} = 2.2\mu\text{F}$, $V_{IN} = V_{OUT} + 2\text{V}$, $I_{OUT} = 0$ to 50mA

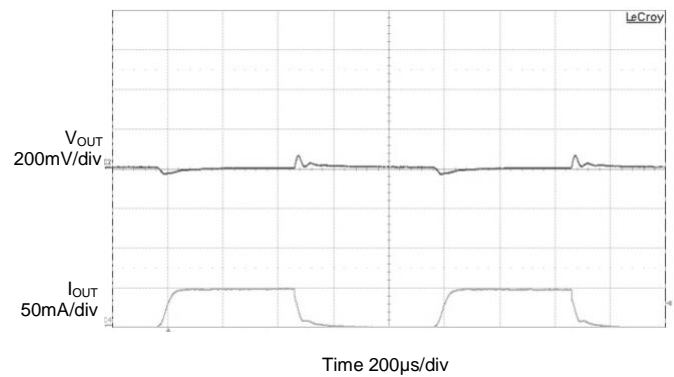

NEW PRODUCT

Ordering Information

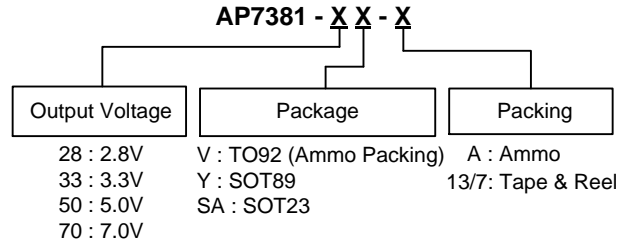

Part Number	Package Code	Packaging	7"/13" Tape and Reel/Ammo	
			Quantity	Part Number Suffix
AP7381-28V-A	V	TO92 (Ammo Packing)	2000/Ammo	-A
AP7381-33V-A	V	TO92 (Ammo Packing)	2000/Ammo	-A
AP7381-50V-A	V	TO92 (Ammo Packing)	2000/Ammo	-A
AP7381-70V-A	V	TO92 (Ammo Packing)	2000/Ammo	-A
AP7381-28Y-13	Y	SOT89	2500/Tape & Reel	-13
AP7381-33Y-13	Y	SOT89	2500/Tape & Reel	-13
AP7381-50Y-13	Y	SOT89	2500/Tape & Reel	-13
AP7381-70Y-13	Y	SOT89	2500/Tape & Reel	-13
AP7381-28SA-7	SA	SOT23	3000/Tape & Reel	-7
AP7381-33SA-7	SA	SOT23	3000/Tape & Reel	-7
AP7381-50SA-7	SA	SOT23	3000/Tape & Reel	-7
AP7381-70SA-7	SA	SOT23	3000/Tape & Reel	-7

Marking Information

(1) SOT89

(Top View)

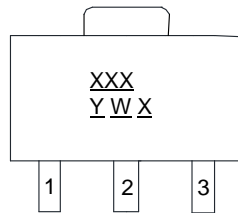

XXX : Identification Code
Y : Year : 0 ~ 9
W : Week : A ~ Z : 1 ~ 26 Week;
 a ~ z : 27 ~ 52 Week;
 z Represents 52 and 53 Week
X : Internal Code

Part Number	Package	Identification Code
AP7381-28Y-13	SOT89	D9C
AP7381-33Y-13	SOT89	D9A
AP7381-50Y-13	SOT89	D9B
AP7381-70Y-13	SOT89	D9D

Marking Information (Cont.)

(2) TO92 (Ammo Packing)

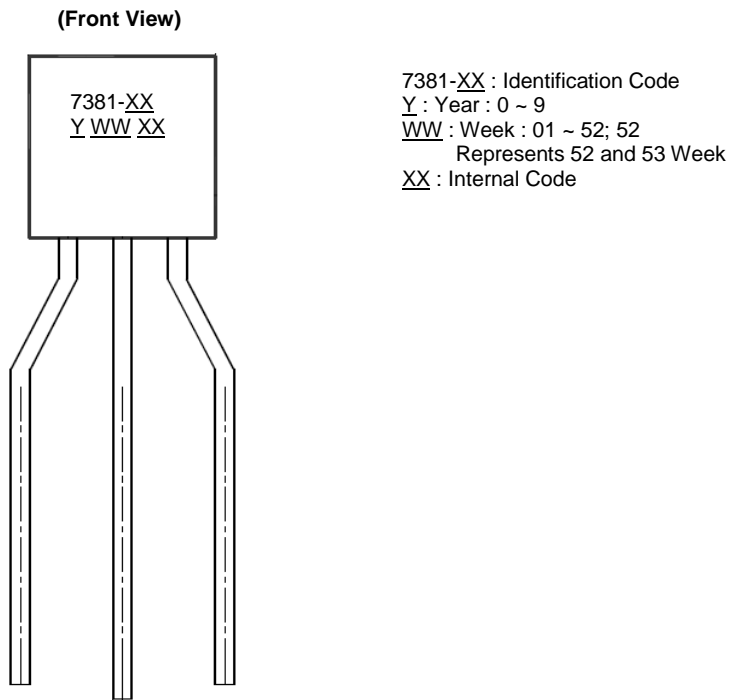

Part Number	Package	Identification Code
AP7381-28V-A	TO92 (Ammo Packing)	7381-28
AP7381-33V-A	TO92 (Ammo Packing)	7381-33
AP7381-50V-A	TO92 (Ammo Packing)	7381-50
AP7381-70V-A	TO92 (Ammo Packing)	7381-70

(3) SOT23

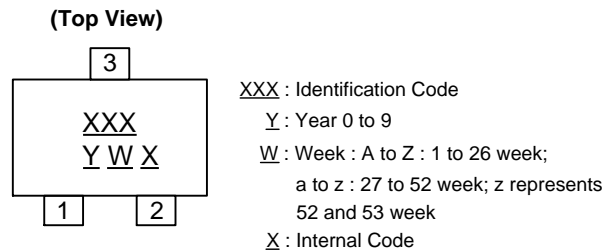

Part Number	Package	Identification Code
AP7381-28SA-7	SOT23	D9C
AP7381-33SA-7	SOT23	D9A
AP7381-50SA-7	SOT23	D9B
AP7381-70SA-7	SOT23	D9D

Package Outline Dimensions (All dimensions in mm.)

(1) Package Type: SOT89

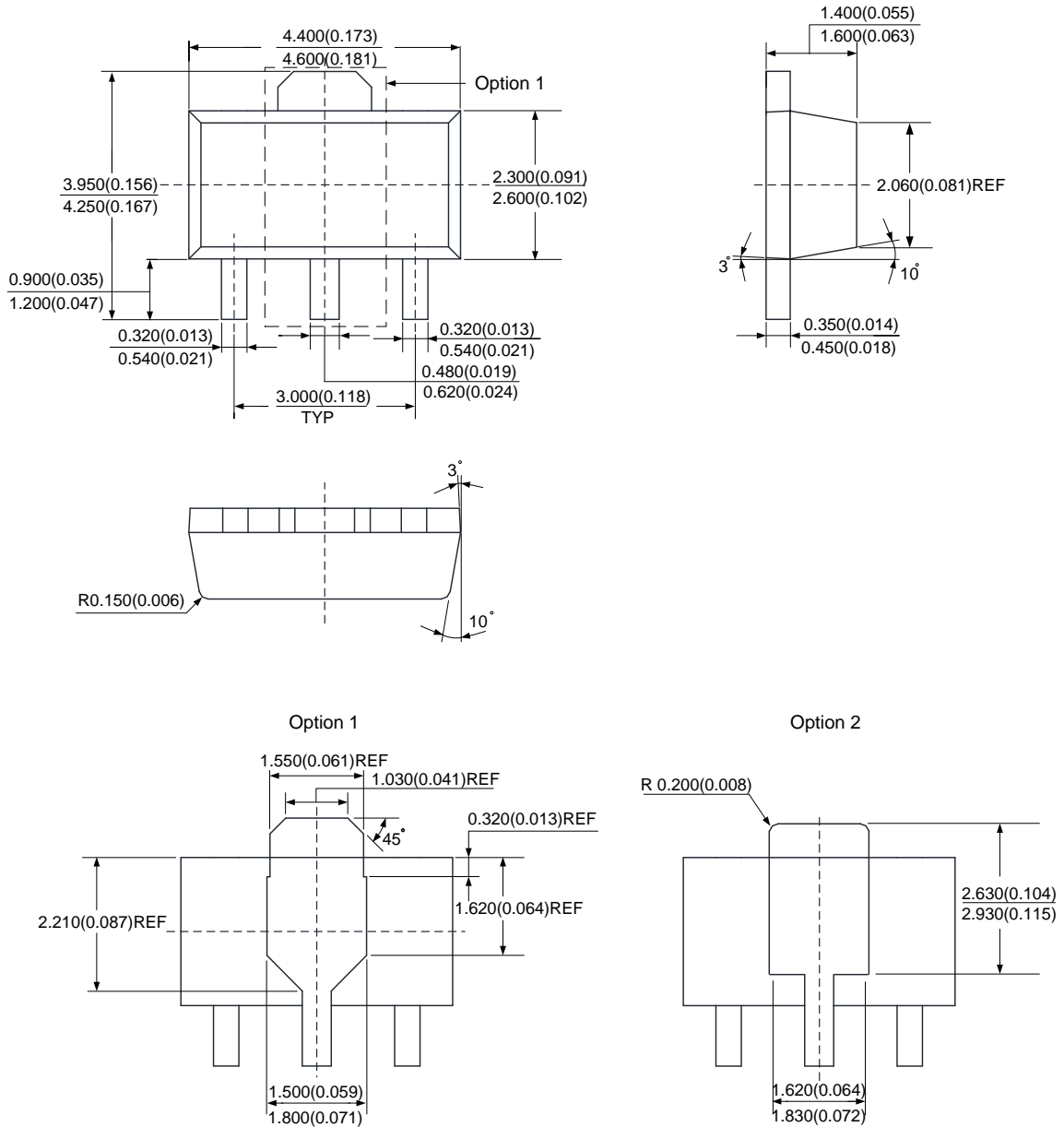

NEW PRODUCT

Package Outline Dimensions (Cont. All dimensions in mm.)

(2) T092 (Ammo Packing)

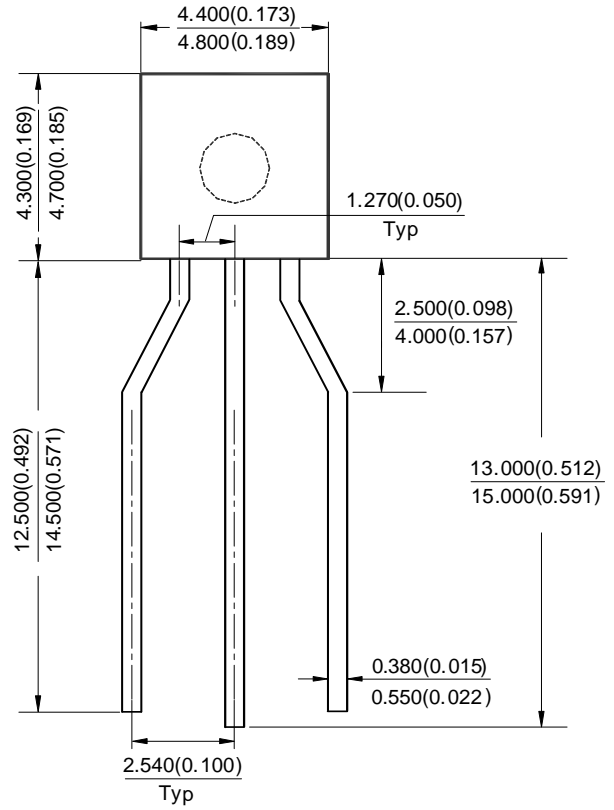
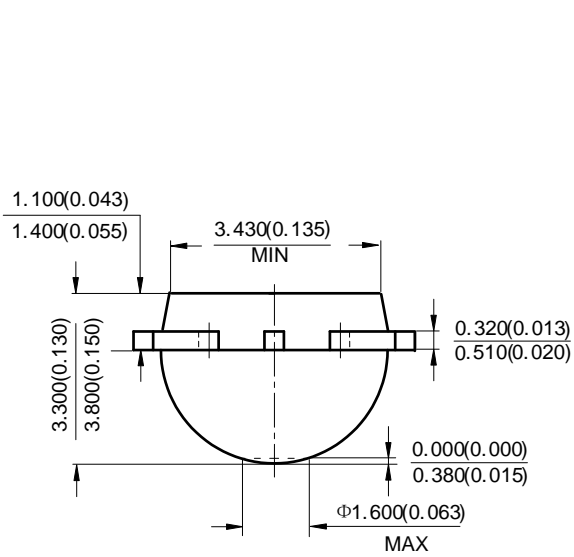

NEW PRODUCT

Suggested Pad Layout

(1) Package Type: SOT89

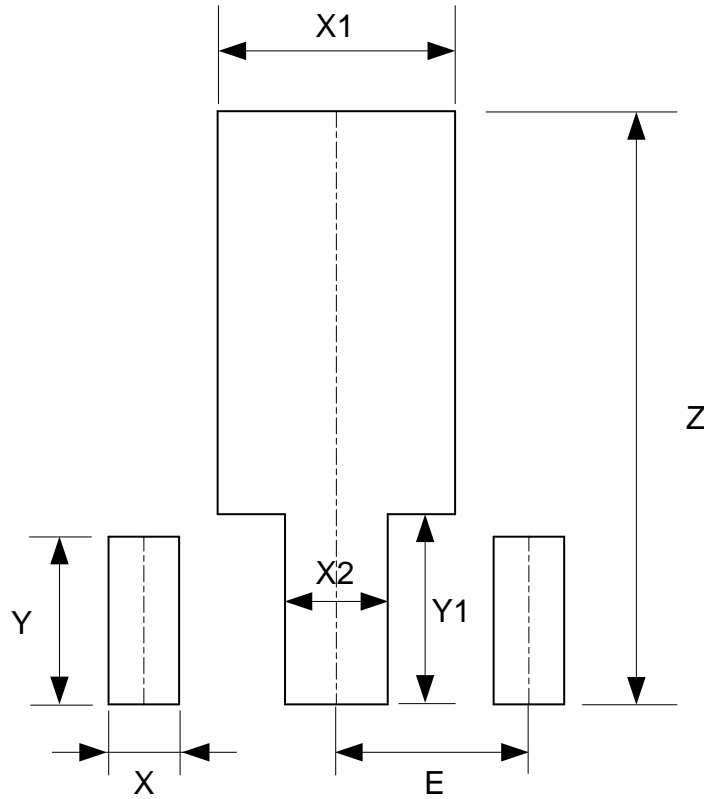

Dimensions	Z (mm)/(inch)	X (mm)/(inch)	X1 (mm)/(inch)	X2 (mm)/(inch)	Y (mm)/(inch)	Y1 (mm)/(inch)	E (mm)/(inch)
Value	4.600/0.181	0.550/0.022	1.850/0.073	0.800/0.031	1.300/0.051	1.475/0.058	1.500/0.059

NEW PRODUCT

Suggested Pad Layout (Cont.)

(2) SOT23

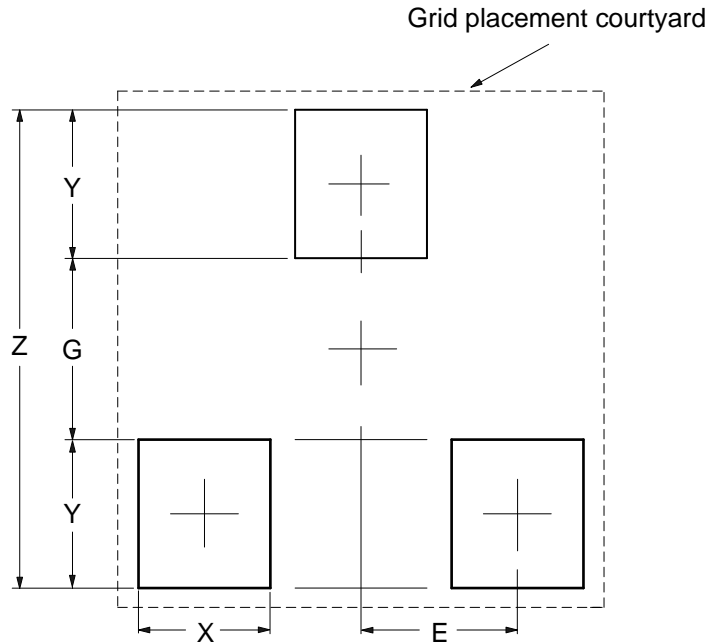

Dimensions	Z (mm)/(inch)	G (mm)/(inch)	X (mm)/(inch)	Y (mm)/(inch)	E (mm)/(inch)
Value	2.900/0.114	1.100/0.043	0.800/0.031	0.900/0.035	0.950/0.037

NEW PRODUCT

IMPORTANT NOTICE

DIODES INCORPORATED MAKES NO WARRANTY OF ANY KIND, EXPRESS OR IMPLIED, WITH REGARDS TO THIS DOCUMENT, INCLUDING, BUT NOT LIMITED TO, THE IMPLIED WARRANTIES OF MERCHANTABILITY AND FITNESS FOR A PARTICULAR PURPOSE (AND THEIR EQUIVALENTS UNDER THE LAWS OF ANY JURISDICTION).

Diodes Incorporated and its subsidiaries reserve the right to make modifications, enhancements, improvements, corrections or other changes without further notice to this document and any product described herein. Diodes Incorporated does not assume any liability arising out of the application or use of this document or any product described herein; neither does Diodes Incorporated convey any license under its patent or trademark rights, nor the rights of others. Any Customer or user of this document or products described herein in such applications shall assume all risks of such use and will agree to hold Diodes Incorporated and all the companies whose products are represented on Diodes Incorporated website, harmless against all damages.

Diodes Incorporated does not warrant or accept any liability whatsoever in respect of any products purchased through unauthorized sales channel. Should Customers purchase or use Diodes Incorporated products for any unintended or unauthorized application, Customers shall indemnify and hold Diodes Incorporated and its representatives harmless against all claims, damages, expenses, and attorney fees arising out of, directly or indirectly, any claim of personal injury or death associated with such unintended or unauthorized application.

Products described herein may be covered by one or more United States, international or foreign patents pending. Product names and markings noted herein may also be covered by one or more United States, international or foreign trademarks.

This document is written in English but may be translated into multiple languages for reference. Only the English version of this document is the final and determinative format released by Diodes Incorporated.

LIFE SUPPORT

Diodes Incorporated products are specifically not authorized for use as critical components in life support devices or systems without the express written approval of the Chief Executive Officer of Diodes Incorporated. As used herein:

A. Life support devices or systems are devices or systems which:

1. are intended to implant into the body, or
2. support or sustain life and whose failure to perform when properly used in accordance with instructions for use provided in the labeling can be reasonably expected to result in significant injury to the user.

B. A critical component is any component in a life support device or system whose failure to perform can be reasonably expected to cause the failure of the life support device or to affect its safety or effectiveness.

Customers represent that they have all necessary expertise in the safety and regulatory ramifications of their life support devices or systems, and acknowledge and agree that they are solely responsible for all legal, regulatory and safety-related requirements concerning their products and any use of Diodes Incorporated products in such safety-critical, life support devices or systems, notwithstanding any devices- or systems-related information or support that may be provided by Diodes Incorporated. Further, Customers must fully indemnify Diodes Incorporated and its representatives against any damages arising out of the use of Diodes Incorporated products in such safety-critical, life support devices or systems.

Copyright © 2018, Diodes Incorporated

www.diodes.com

Mouser Electronics

Authorized Distributor

Click to View Pricing, Inventory, Delivery & Lifecycle Information:

Diodes Incorporated:

[AP7381-33Y-13](#) [AP7381-50Y-13](#) [AP7381-50V-A](#) [AP7381-33V-A](#) [AP7381-28Y-13](#) [AP7381-70Y-13](#) [AP7381-28SA-7](#)
[AP7381-28V-A](#) [AP7381-33SA-7](#) [AP7381-50SA-7](#) [AP7381-70SA-7](#) [AP7381-70V-A](#)