

TPS7A8101-Q1 Low-Noise, Wide-Bandwidth, High PSRR, Low-Dropout 1-A Linear Regulator

1 Features

- Qualified for Automotive Applications
- AEC-Q100 Qualified With the Following Results:
 - Device Temperature Grade 1: -40°C to 125°C Ambient Operating Temperature Range
 - Device HBM ESD Classification Level H2
 - Device CDM ESD Classification Level C4B
- Low-Dropout 1-A Regulator with Enable
- Adjustable Output Voltage: 0.8 V to 6 V
- Wide-Bandwidth High PSRR:
 - 80 dB at 1 kHz
 - 60 dB at 100 kHz
 - 54 dB at 1 MHz
- Low Noise: $23.5\ \mu\text{V}_{\text{RMS}}$ typical (100 Hz to 100 kHz)
- Stable With 4.7- μF Output Capacitance
- Excellent Load and Line Transient Response
- 3% Overall Accuracy (Over Load, Line, Temperature)
- Over-Current and Overtemperature Protection
- Very Low Dropout: 170 mV Typical at 1 A
- Package: 3-mm x 3-mm SON-8

2 Applications

- RF Power in Automotive Applications
- Automotive ADAS ECUs
- Telematic Control Units
- Audio
- High-Speed I/F (PLL and VCO)

3 Description

The TPS7A8101-Q1 low-dropout linear regulator (LDO) offers very good performance in output noise and power-supply rejection ratio (PSRR). This LDO uses an advanced BiCMOS process and a PMOSFET pass device to achieve very low noise, excellent transient response, and excellent PSRR performance.

The TPS7A8101-Q1 device is stable with a 4.7- μF ceramic output capacitor and uses a precision voltage reference and feedback loop to achieve a worst-case accuracy of 3% over all load, line, process, and temperature variations.

This device is fully specified over the temperature range of $T_A = -40^{\circ}\text{C}$ to 125°C and is offered in a 3-mm x 3-mm, SON-8 package with a thermal pad.

Device Information⁽¹⁾

PART NUMBER	PACKAGE	BODY SIZE (NOM)
TPS7A8101-Q1	SON (8)	3.00 mm x 3.00 mm

(1) For all available packages, see the orderable addendum at the end of the datasheet.

4 Typical Application Circuit

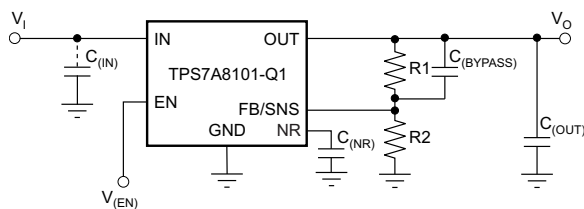

Typical Power-Supply Ripple Rejection

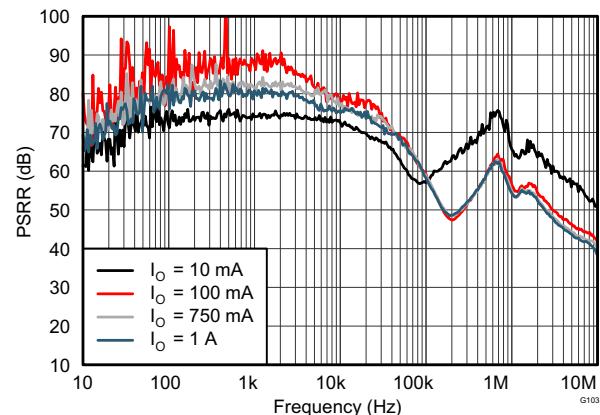

Table of Contents

1 Features	1	8.3 Feature Description	11
2 Applications	1	8.4 Device Functional Modes	12
3 Description	1	9 Application and Implementation	13
4 Typical Application Circuit	1	9.1 Application Information	13
5 Revision History	2	9.2 Typical Application	13
6 Pin Configuration and Functions	3	10 Power Supply Recommendations	17
7 Specifications	4	11 Layout	17
7.1 Absolute Maximum Ratings	4	11.1 Layout Guidelines	17
7.2 Handling Ratings	4	11.2 Layout Example	17
7.3 Recommended Operating Conditions	4	11.3 Thermal Information	18
7.4 Thermal Information	4	12 Device and Documentation Support	21
7.5 Electrical Characteristics	5	12.1 Documentation Support	21
7.6 Typical Characteristics	6	12.2 Trademarks	21
8 Detailed Description	11	12.3 Electrostatic Discharge Caution	21
8.1 Overview	11	12.4 Glossary	21
8.2 Functional Block Diagram	11	13 Mechanical, Packaging, and Orderable Information	21

5 Revision History

Changes from Original (April 2014) to Revision A

Page

• Changed device status from <i>Product Preview</i> to <i>Production Data</i>	1
---	----------

6 Pin Configuration and Functions

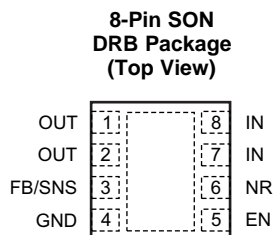

Pin Functions

PIN		DESCRIPTION
NAME	NO.	
EN	5	Driving this pin high turns on the regulator. Driving this pin low puts the regulator into shutdown mode. See to the Shutdown section for more details. The EN pin must not be left floating and can be connected to the IN pin if not used.
FB/SNS	3	This pin is the input to the error amplifier and is used to set the output voltage of the device.
GND	4	Ground
IN	7	Unregulated input supply
	8	
NR	6	Connect an external capacitor between this pin and ground to reduce output noise to very low levels. The capacitor also slows down the V_O ramp (RC soft start).
OUT	1	Regulator output. A 4.7- μ F or larger ceramic capacitor is required for stability.
	2	
Thermal Pad	—	The Thermal Pad should be connected to GND.

7 Specifications

7.1 Absolute Maximum Ratings

Over operating free-air temperature range (unless otherwise noted).⁽¹⁾

		MIN	MAX	UNIT
Voltage	IN	-0.3	7	V
	FB/SNS, NR	-0.3	3.6	V
	EN	-0.3	$V_I + 0.3^{(2)}$	V
	OUT	-0.3	7	V
Current	OUT	Internally Limited		A
Operating junction temperature, T_J		-55	150	°C

- (1) Stresses beyond those listed under *Absolute Maximum Ratings* may cause permanent damage to the device. These are stress ratings only, and functional operation of the device at these or any other conditions beyond those indicated is not implied. Exposure to absolute-maximum-rated conditions for extended periods may affect device reliability.
- (2) $V_{(EN)}$ absolute maximum rating is $V_I + 0.3$ V or + 7 V, whichever is smaller.

7.2 Handling Ratings

		MIN	MAX	UNIT	
T_{stg}	Storage temperature range	-55	150	°C	
$V_{(ESD)}$	Electrostatic discharge	Human body model (HBM), per AEC Q100-002, classification level H2 ⁽¹⁾		kV	
		Charged device model (CDM), per JEDEC specification JESD22-C101, classification level C4B	Corner pins (1, 4, 5, and 8)	-750 750	V
			Other pins	-500 500	

- (1) AEC Q100-002 indicates HBM stressing is done in accordance with the ANSI/ESDA/JEDEC JS-001 Specification.

7.3 Recommended Operating Conditions

Over operating free-air temperature range (unless otherwise noted)

		MIN	MAX	UNIT
V_I	Input voltage	2.2	6.5	V
I_O	Output current	0	1	A
T_A	Operating free air temperature	-40	125	°C

7.4 Thermal Information

THERMAL METRIC ⁽¹⁾		DRB (8 PINS)	UNIT
$R_{\theta JA}$	Junction-to-ambient thermal resistance	45.7	°C/W
$R_{\theta JC(top)}$	Junction-to-case (top) thermal resistance	53.1	
$R_{\theta JB}$	Junction-to-board thermal resistance	21.2	
Ψ_{JT}	Junction-to-top characterization parameter	0.9	
Ψ_{JB}	Junction-to-board characterization parameter	21.4	
$R_{\theta JC(bot)}$	Junction-to-case (bottom) thermal resistance	5.2	

- (1) For more information about traditional and new thermal metrics, see the [IC Package Thermal Metrics application report, SPRA953A](#).

7.5 Electrical Characteristics

Over the temperature range of $-40^{\circ}\text{C} \leq T_A, T_J \leq 125^{\circ}\text{C}$, $V_I = V_{\text{Onom}} + 0.5\text{ V}$ or 2.2 V (whichever is greater), $I_O = 1\text{ mA}$, $V_{(\text{EN})} = 2.2\text{ V}$, $C_{(\text{OUT})} = 4.7\text{ }\mu\text{F}$, $C_{(\text{NR})} = 0.01\text{ }\mu\text{F}$, and $C_{(\text{BYPASS})} = 0\text{ }\mu\text{F}$, unless otherwise noted. The device is tested at $V_O = 0.8\text{ V}$ and $V_O = 6\text{ V}$. Typical values are at $T_J = 25^{\circ}\text{C}$.

PARAMETER		TEST CONDITIONS	MIN	TYP	MAX	UNIT
V_I	Input voltage range ⁽¹⁾		2.2		6.5	V
$V_{(\text{NR})}$	Internal reference		0.79	0.8	0.81	V
V_O	Output voltage range		0.8		6	V
	Output accuracy ⁽²⁾	$V_O + 0.5\text{ V} \leq V_I \leq 6\text{ V}$, $V_I \geq 2.5\text{ V}$, $100\text{ mA} \leq I_O \leq 500\text{ mA}$, $0^{\circ}\text{C} \leq T_J \leq 85^{\circ}\text{C}$	-2%		2%	
		$V_O + 0.5\text{ V} \leq V_I \leq 6.5\text{ V}$, $V_I \geq 2.2\text{ V}$, $100\text{ mA} \leq I_O \leq 1\text{ A}$	-3%	$\pm 0.3\%$	3%	
$\Delta V_{O(\Delta V_I)}$	Line regulation	$V_{\text{Onom}} + 0.5\text{ V} \leq V_I \leq 6.5\text{ V}$, $V_I \geq 2.2\text{ V}$, $I_O = 100\text{ mA}$		150		$\mu\text{V/V}$
$\Delta V_{O(\Delta I_L)}$	Load regulation	$100\text{ mA} \leq I_O \leq 1\text{ A}$		2		$\mu\text{V/mA}$
V_{DO}	Dropout voltage ⁽³⁾	$V_O + 0.5\text{ V} \leq V_I \leq 6.5\text{ V}$, $V_I \geq 2.2\text{ V}$, $I_O = 500\text{ mA}$, $V_{(\text{FB}/\text{SNS})} = \text{GND}$			250	mV
		$V_O + 0.5\text{ V} \leq V_I \leq 6.5\text{ V}$, $V_I \geq 2.5\text{ V}$, $I_O = 750\text{ mA}$, $V_{(\text{FB}/\text{SNS})} = \text{GND}$			350	mV
		$V_O + 0.5\text{ V} \leq V_I \leq 6.5\text{ V}$, $V_I \geq 2.5\text{ V}$, $I_O = 1\text{ A}$, $V_{(\text{FB}/\text{SNS})} = \text{GND}$			500	mV
I_L	Output current-limit	$V_O = 0.85 \times V_{\text{Onom}}$, $V_I \geq 3.3\text{ V}$	1100	1400	2000	mA
$I_{(\text{GND})}$	Ground pin current	$I_O = 1\text{ mA}$		60	100	μA
		$I_O = 1\text{ A}$			350	μA
$I_{L(\text{sd})}$	Shutdown current ($I_{(\text{GND})}$)	$V_{(\text{EN})} \leq 0.4\text{ V}$, $V_I \geq 2.2\text{ V}$, $R_L = 1\text{ k}\Omega$, $0^{\circ}\text{C} \leq T_J \leq 125^{\circ}\text{C}$		0.2	2.5	μA
$I_{(\text{FB}/\text{SNS})}$	Feedback pin current	$V_I = 6.5\text{ V}$, $V_{(\text{FB}/\text{SNS})} = 0.8\text{ V}$		0.02	1	μA
PSRR	Power-supply rejection ratio	$V_I = 4.3\text{ V}$, $V_O = 3.3\text{ V}$, $I_O = 750\text{ mA}$	$f = 100\text{ Hz}$	80		dB
			$f = 1\text{ kHz}$	82		dB
			$f = 10\text{ kHz}$	78		dB
			$f = 100\text{ kHz}$	60		dB
			$f = 1\text{ MHz}$	54		dB
V_n	Output noise voltage	$\text{BW} = 100\text{ Hz to } 100\text{ kHz}$, $V_I = 3.8\text{ V}$, $V_O = 3.3\text{ V}$, $I_O = 100\text{ mA}$, $C_{(\text{NR})} = C_{(\text{BYPASS})} = 470\text{ nF}$		23.5		μV_{RMS}
$V_{(\text{EN})\text{H}}$	Enable high (enabled)	$2.2\text{ V} \leq V_I \leq 3.6\text{ V}$, $R_L = 1\text{ k}\Omega$	1.2			V
		$3.6\text{ V} < V_I \leq 6.5\text{ V}$, $R_L = 1\text{ k}\Omega$	1.35			V
$V_{(\text{EN})\text{L}}$	Enable low (shutdown)	$R_L = 1\text{ k}\Omega$	0		0.4	V
$I_{(\text{EN})}$	Enable pin current, enabled	$V_I = V_{(\text{EN})} = 6.5\text{ V}$		0.02	1	μA
t_{st}	Startup time	$V_{\text{Onom}} = 3.3\text{ V}$, $V_O = 0\%$ to $90\% V_{\text{Onom}}$, $R_1 = 3.3\text{ k}\Omega$, $C_{(\text{OUT})} = 10\text{ }\mu\text{F}$, $C_{(\text{NR})} = 470\text{ nF}$		80		ms
UVLO	Undervoltage lockout	V_I rising, $R_L = 1\text{ k}\Omega$	1.86	2	2.1	V
	Hysteresis	V_I falling, $R_L = 1\text{ k}\Omega$		75		mV
T_{sd}	Thermal shutdown temperature	Shutdown, temperature increasing		160		$^{\circ}\text{C}$
		Reset, temperature decreasing		140		$^{\circ}\text{C}$

(1) Minimum $V_I = V_O + V_{\text{DO}}$ or 2.2 V , whichever is greater.

(2) The TPS7A8101-Q1 does not include external resistor tolerances and it is not tested at this condition: $V_O = 0.8\text{ V}$, $4.5\text{ V} \leq V_I \leq 6.5\text{ V}$, and $750\text{ mA} \leq I_O \leq 1\text{ A}$ because the power dissipation is greater than the maximum rating of the package.

(3) V_{DO} is not measured for fixed output voltage devices with $V_O < 1.7\text{ V}$ because minimum $V_I = 2.2\text{ V}$.

7.6 Typical Characteristics

At $V_{O\text{nom}} = 3.3\text{ V}$, $V_1 = V_{O\text{nom}} + 0.5\text{ V}$ or 2.2 V (whichever is greater), $I_O = 100\text{ mA}$, $V_{(EN)} = V_1$, $C_{(IN)} = 1\text{ }\mu\text{F}$, $C_{(OUT)} = 4.7\text{ }\mu\text{F}$, and $C_{(NR)} = 0.01\text{ }\mu\text{F}$; all temperature values refer to T_J , unless otherwise noted.

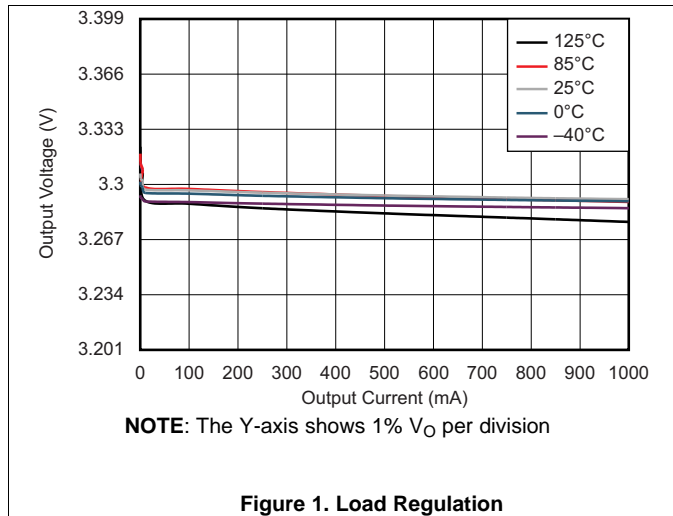

Figure 1. Load Regulation

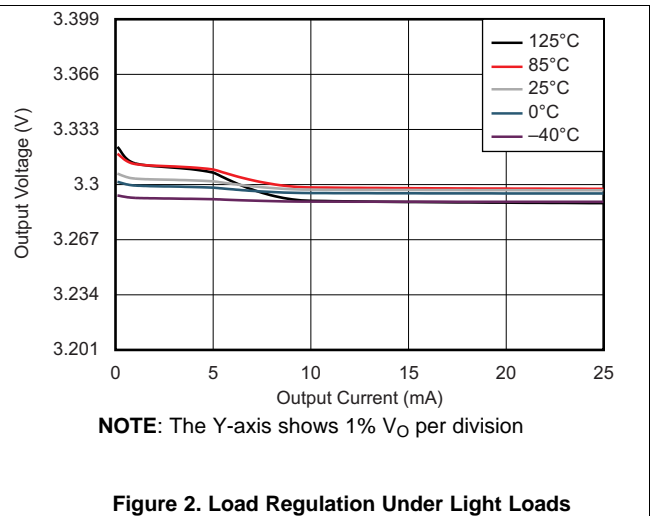

Figure 2. Load Regulation Under Light Loads

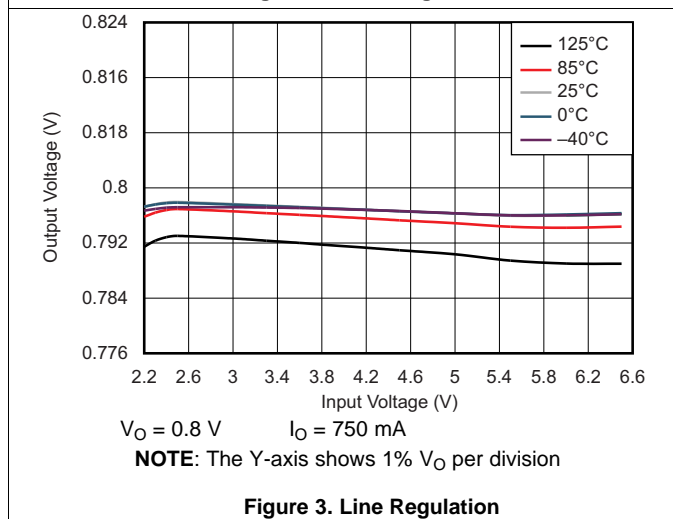

Figure 3. Line Regulation

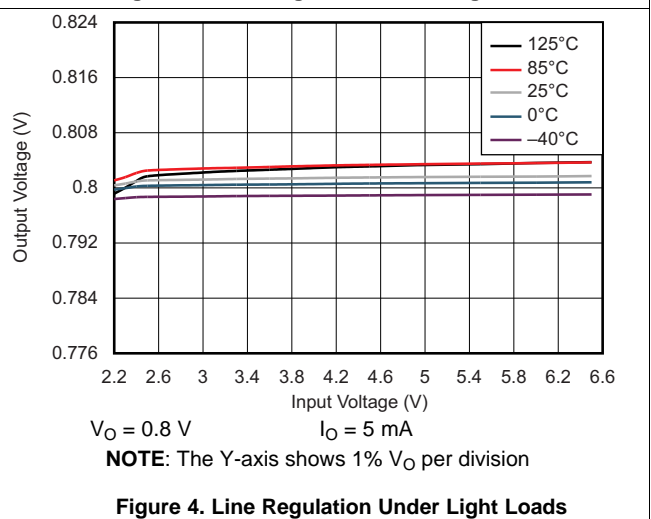

Figure 4. Line Regulation Under Light Loads

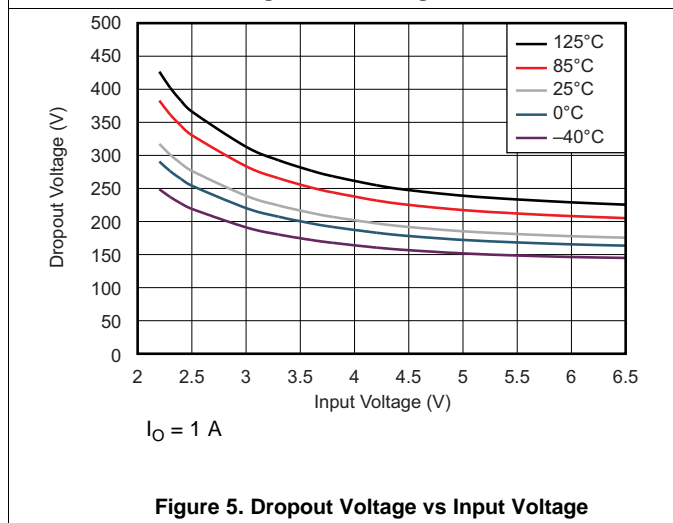

Figure 5. Dropout Voltage vs Input Voltage

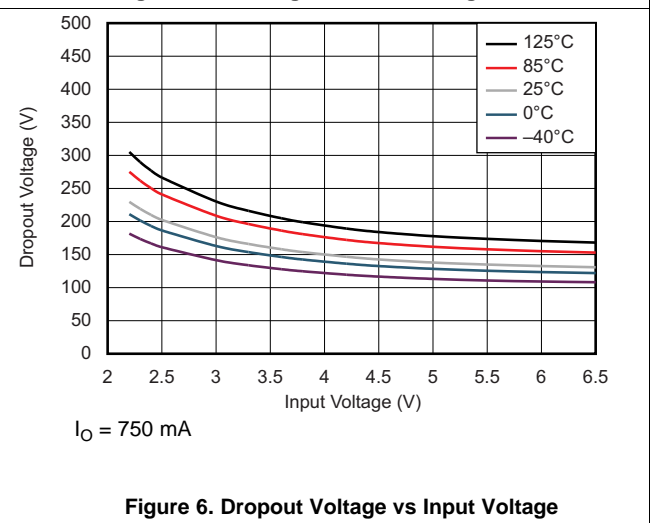
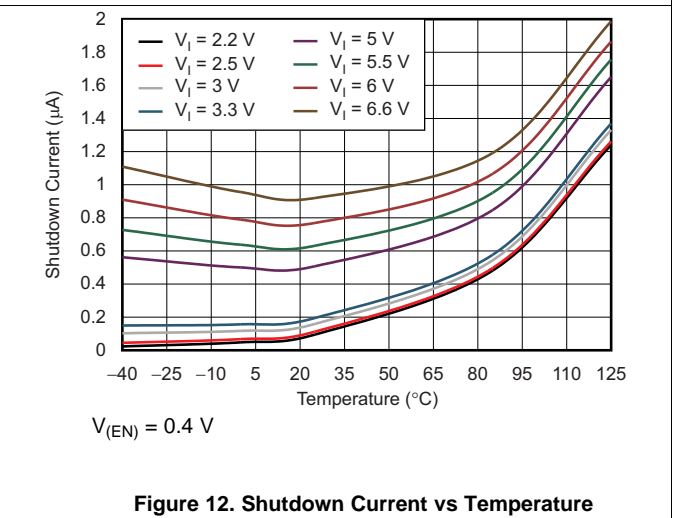
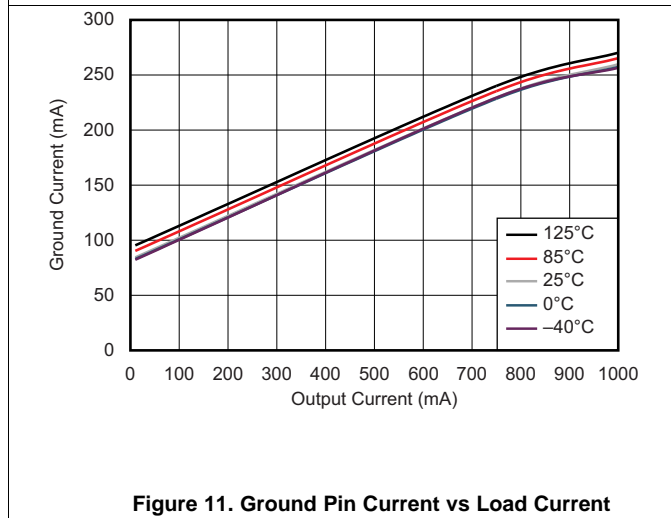
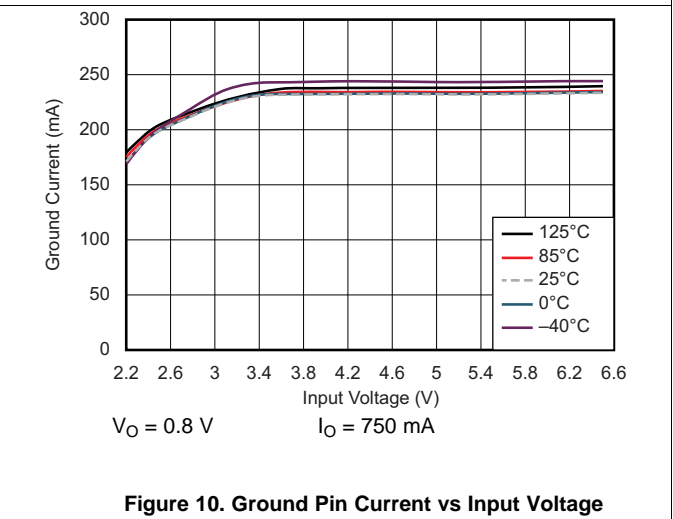
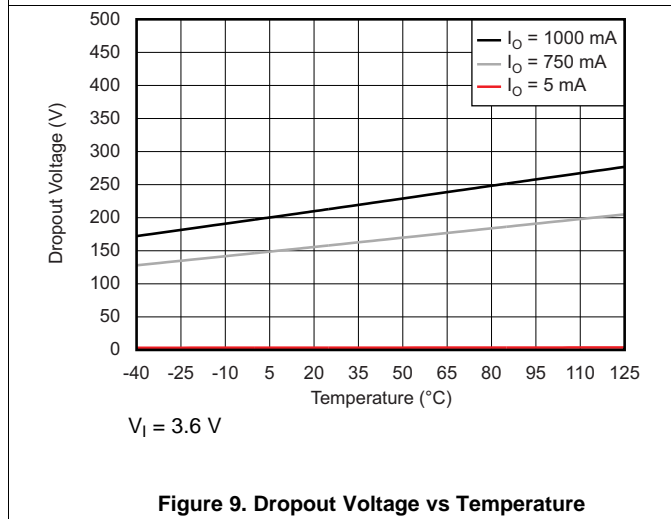
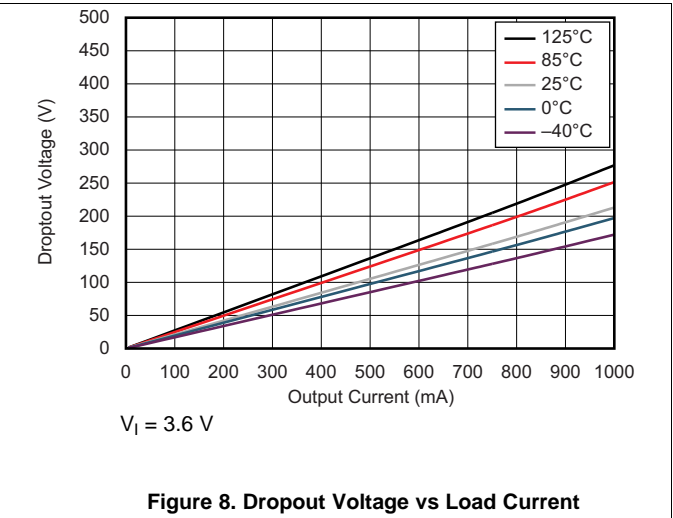
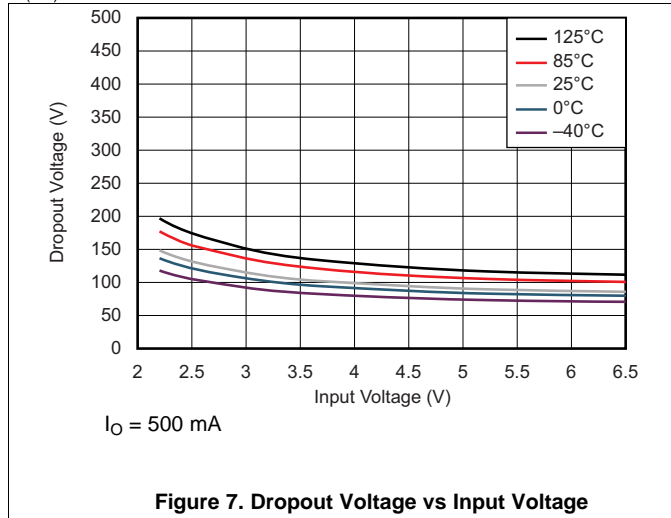

Figure 6. Dropout Voltage vs Input Voltage

Typical Characteristics (continued)

At $V_{Onom} = 3.3\text{ V}$, $V_I = V_{Onom} + 0.5\text{ V}$ or 2.2 V (whichever is greater), $I_O = 100\text{ mA}$, $V_{(EN)} = V_I$, $C_{(IN)} = 1\text{ }\mu\text{F}$, $C_{(OUT)} = 4.7\text{ }\mu\text{F}$, and $C_{(NR)} = 0.01\text{ }\mu\text{F}$; all temperature values refer to T_J , unless otherwise noted.



Typical Characteristics (continued)

At $V_{Onom} = 3.3\text{ V}$, $V_I = V_{Onom} + 0.5\text{ V}$ or 2.2 V (whichever is greater), $I_O = 100\text{ mA}$, $V_{(EN)} = V_I$, $C_{(IN)} = 1\text{ }\mu\text{F}$, $C_{(OUT)} = 4.7\text{ }\mu\text{F}$, and $C_{(NR)} = 0.01\text{ }\mu\text{F}$; all temperature values refer to T_J , unless otherwise noted.

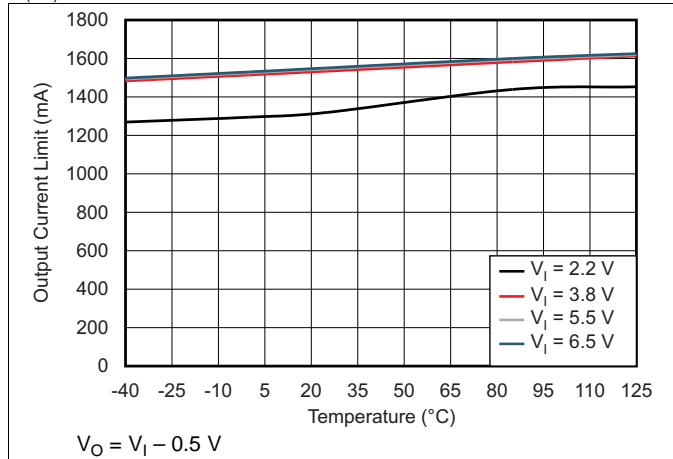

Figure 13. Current-Limit vs Temperature

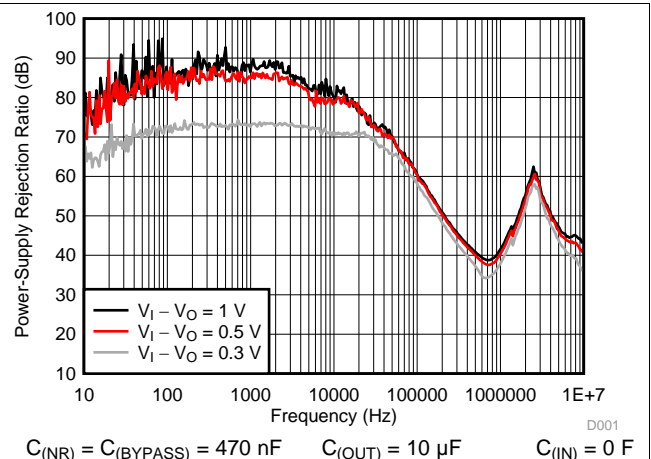

Figure 14. PSRR vs Frequency

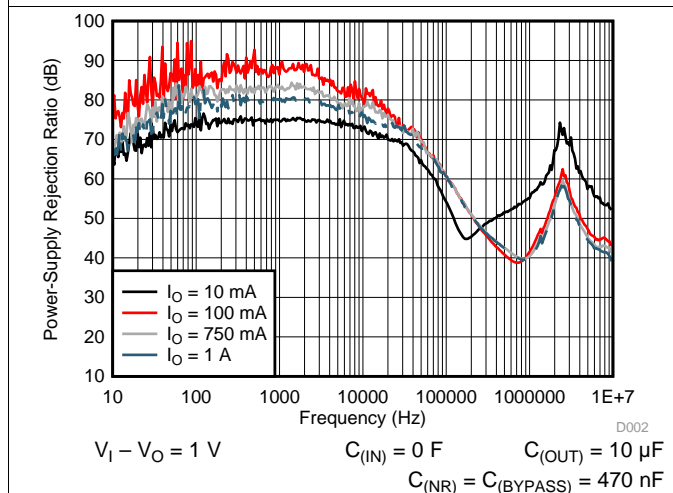

Figure 15. PSRR vs Frequency

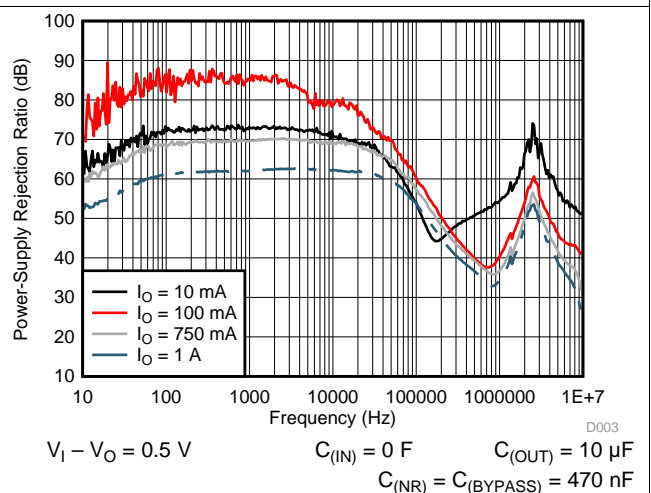

Figure 16. PSRR vs Frequency

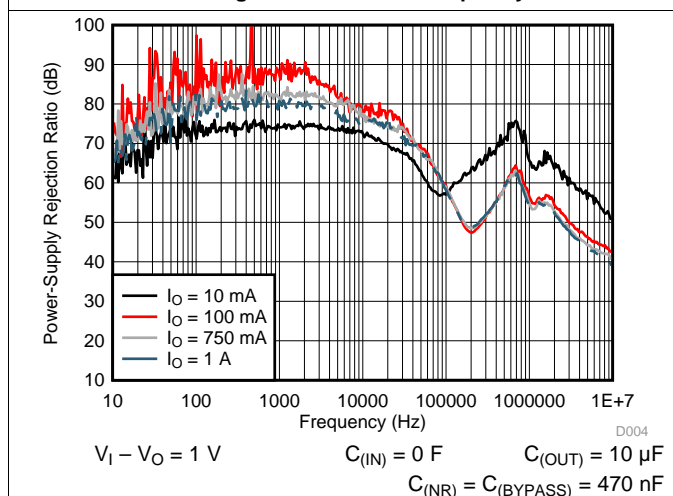

Figure 17. PSRR vs Frequency

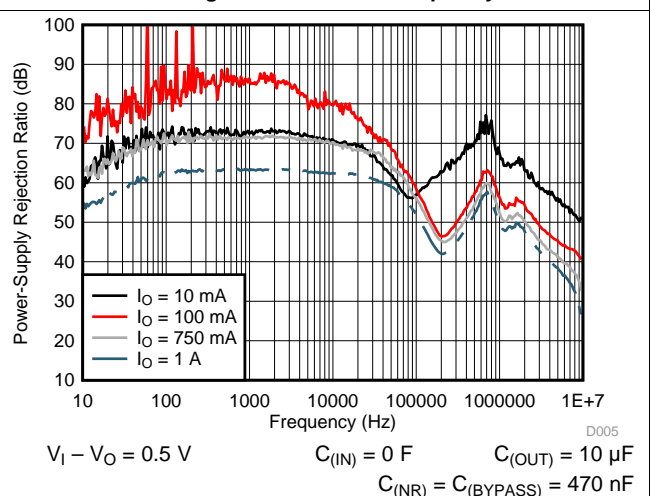

Figure 18. PSRR vs Frequency

Typical Characteristics (continued)

At $V_{Onom} = 3.3\text{ V}$, $V_I = V_{Onom} + 0.5\text{ V}$ or 2.2 V (whichever is greater), $I_O = 100\text{ mA}$, $V_{(EN)} = V_I$, $C_{(IN)} = 1\text{ }\mu\text{F}$, $C_{(OUT)} = 4.7\text{ }\mu\text{F}$, and $C_{(NR)} = 0.01\text{ }\mu\text{F}$; all temperature values refer to T_J , unless otherwise noted.

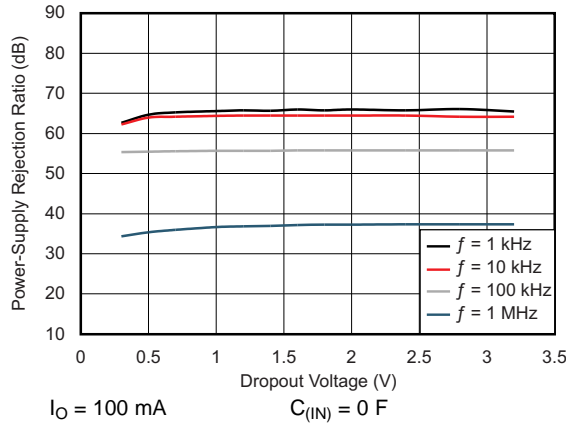

Figure 19. PSRR vs Dropout Voltage

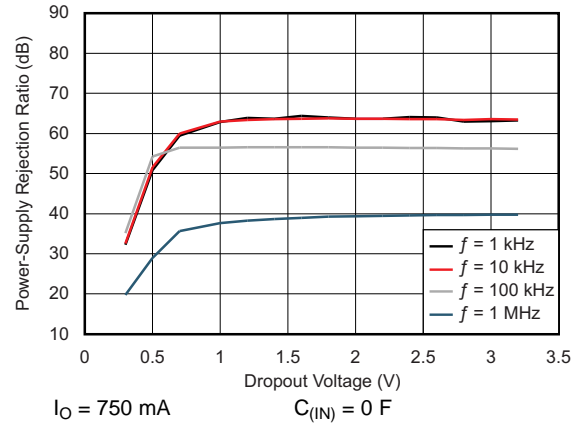

Figure 20. PSRR vs Dropout Voltage

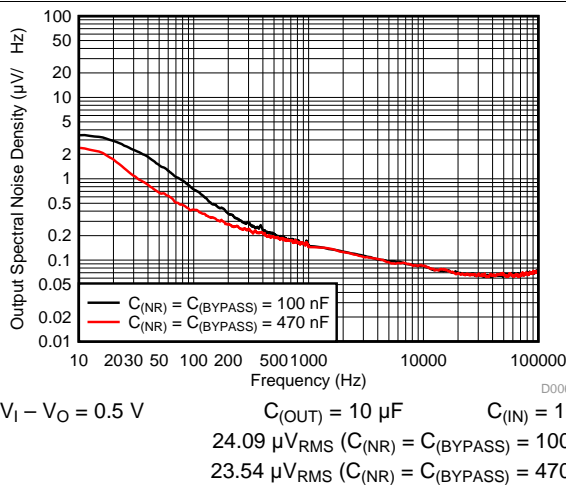

Figure 21. Output Spectral Noise Density vs Frequency (RMS noise (100 Hz to 100 kHz))

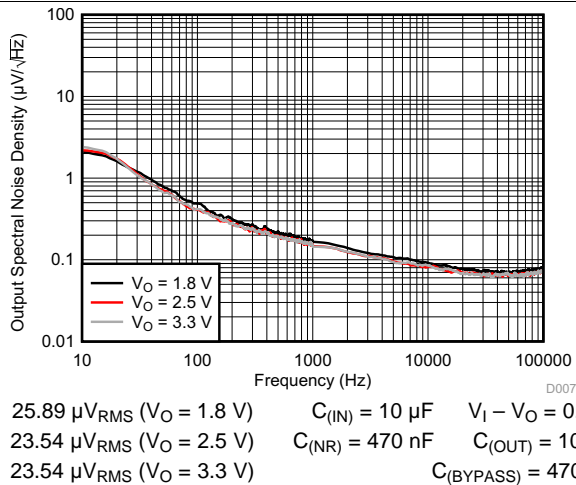

Figure 22. Output Spectral Noise Density vs Frequency (RMS noise (100 Hz to 100 kHz))

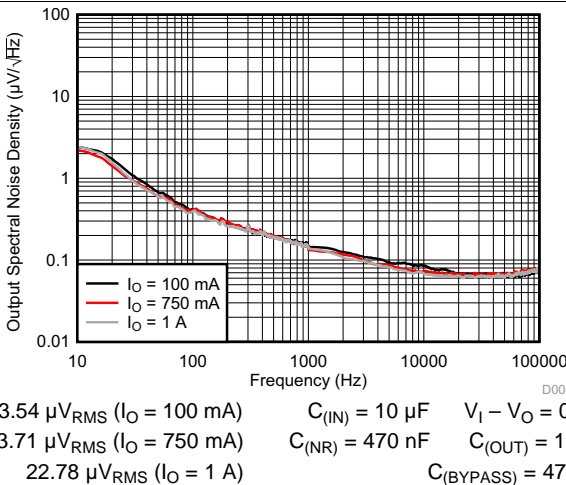

Figure 23. Output Spectral Noise Density vs Frequency (RMS noise (100 Hz to 100 kHz))

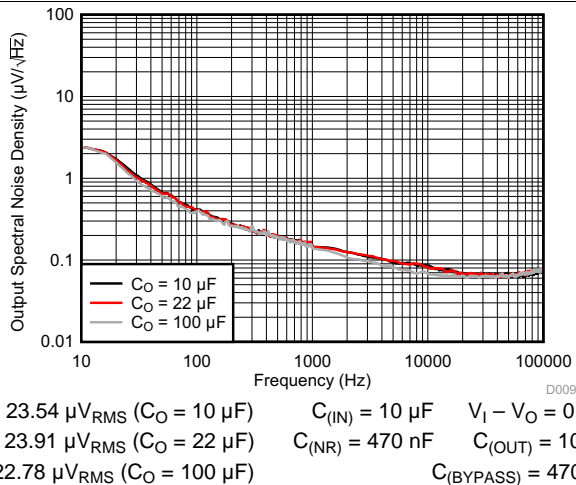
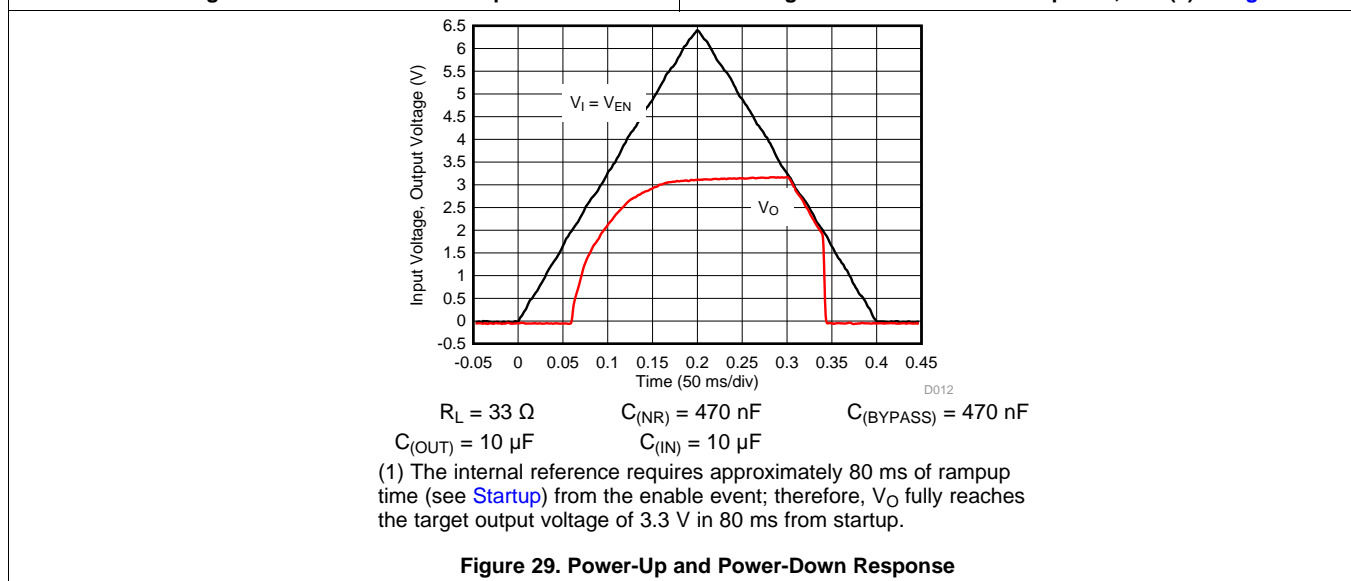
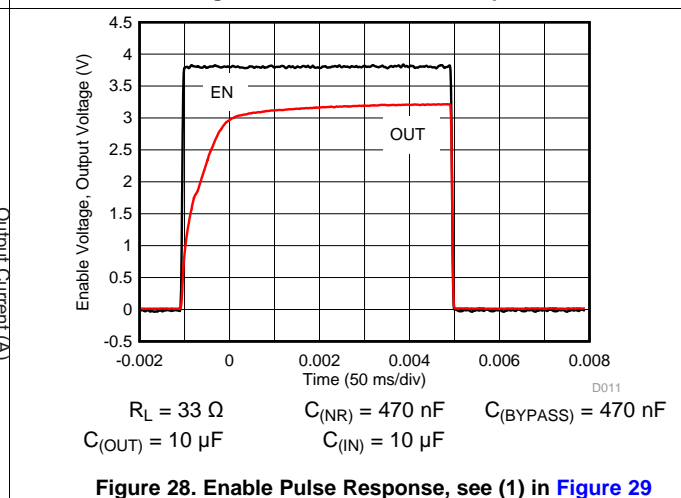
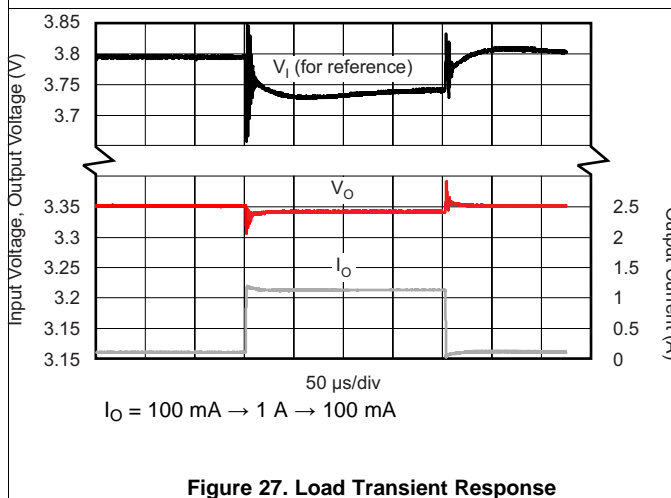
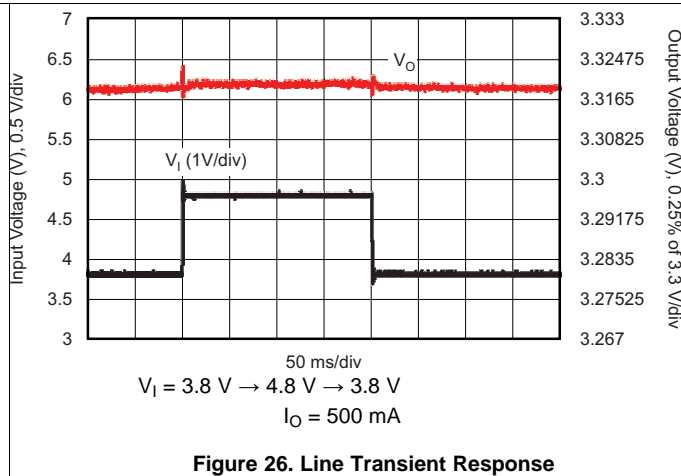
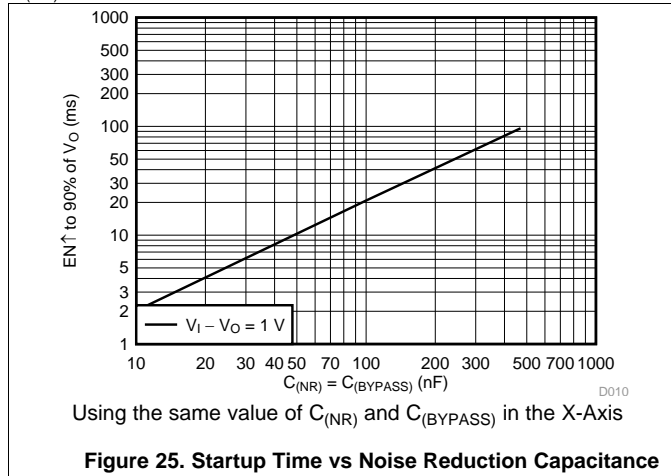

Figure 24. Output Spectral Noise Density vs Frequency (RMS noise (100 Hz to 100 kHz))

Typical Characteristics (continued)

At $V_{Onom} = 3.3\text{ V}$, $V_I = V_{Onom} + 0.5\text{ V}$ or 2.2 V (whichever is greater), $I_O = 100\text{ mA}$, $V_{(EN)} = V_I$, $C_{(IN)} = 1\text{ }\mu\text{F}$, $C_{(OUT)} = 4.7\text{ }\mu\text{F}$, and $C_{(NR)} = 0.01\text{ }\mu\text{F}$; all temperature values refer to T_J , unless otherwise noted.



8 Detailed Description

8.1 Overview

The TPS7A8101-Q1 device belongs to a family of new-generation LDO regulators that use innovative circuitry to achieve wide bandwidth and high loop gain, resulting in extremely high PSRR (over a 1-MHz range) even with very low headroom ($V_I - V_O$). A noise-reduction capacitor ($C_{(NR)}$) at the NR pin and a bypass capacitor ($C_{(BYPASS)}$) decrease noise generated by the bandgap reference in order to improve PSRR, while a quick-start circuit fast-charges the noise-reduction capacitor. This family of regulators offers sub-bandgap output voltages, current-limit, and thermal protection, and is fully specified from -40°C to 125°C .

8.2 Functional Block Diagram

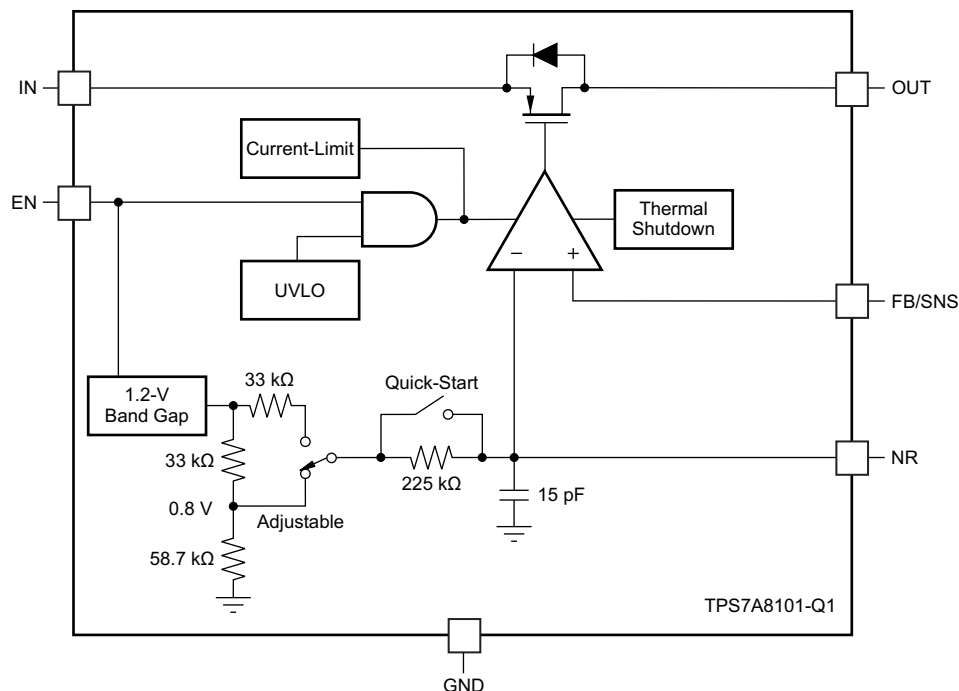

Figure 30. Functional Block Diagram

8.3 Feature Description

8.3.1 Internal Current-Limit

The TPS7A8101-Q1 internal current-limit helps protect the regulator during fault conditions. During the current-limit, the output sources a fixed amount of current that is largely independent of the output voltage. For reliable operation, the device should not be operated in a current-limit state for extended periods of time.

The PMOS pass element in the TPS7A8101-Q1 device has a built-in body diode that conducts current when the voltage at the OUT pin ($V_{(OUT)}$) exceeds the voltage at the IN pin ($V_{(IN)}$). This current is not limited, so if extended reverse-voltage operation is anticipated, external limiting may be appropriate.

8.3.2 Shutdown

The enable pin (EN) is active high and is compatible with standard-voltage and low-voltage TTL-CMOS levels. When shutdown capability is not required, the EN pin can connect to the IN pin.

Feature Description (continued)

8.3.3 Startup

Through a lower resistance, the bandgap reference can quickly charge the noise-reduction capacitor ($C_{(NR)}$). The TPS7A8101-Q1 device has a *quick-start* circuit to quickly charge $C_{(NR)}$, if present; see [Figure 30](#). At startup, this quick-start switch is closed, with only 33 k Ω of resistance between the bandgap reference and the NR pin. The quick-start switch opens approximately 100 ms after any device-enabling event, and the resistance between the bandgap reference and the NR pin becomes higher in value (approximately 250 k Ω) to form a very-good low-pass (RC) filter. This low-pass filter reduces the noise present on the reference voltage; therefore, reducing the noise on the output.

Inrush current can cause problems in many applications. The 33-k Ω resistance during the startup period is intentionally placed between the bandgap reference and the NR pin in order to slow down the reference voltage rampup, thus reducing the inrush current.

Use [Equation 1](#) to calculate the startup time with other $C_{(NR)}$ values. For example, the capacitance of connecting the recommended $C_{(NR)}$ value of 0.47 μ F along with the 33-k Ω resistance causes an 80-ms RC delay (approximately).

$$t_{st} \text{ (s)} = 170000 \times C_{(NR)} \text{ (F)} \quad (1)$$

Although the noise-reduction effect is nearly saturated at 0.47 μ F, connecting a $C_{(NR)}$ value greater than 0.47 μ F can additionally help reduce noise. However, when connecting a $C_{(NR)}$ value greater than 0.47 μ F, the startup time is extremely long because the quick-start switch opens after approximately 100 ms. That is, if $C_{(NR)}$ is not fully charged during this 100-ms period, $C_{(NR)}$ finishes charging through a higher resistance of 250 k Ω , and takes much longer to fully charge.

NOTE

A low-leakage capacitor should be used for $C_{(NR)}$. Most ceramic capacitors are suitable

8.3.4 Undervoltage Lockout (UVLO)

The TPS7A8101-Q1 device uses an undervoltage-lockout (UVLO) circuit to ensure that the output is shut off until the internal circuitry has enough voltage to operate properly. The UVLO circuit has a deglitch feature so that the circuit typically ignores undershoot transients on the input if the duration is less than 50- μ s.

8.4 Device Functional Modes

Driving the EN pin over 1.2 V for V_I between 2.2 V to 3.6 V or 1.35 V for V_I between 3.6 V and 6.5 V turns on the regulator. Driving the EN pin below 0.4 V causes the regulator to enter shutdown mode.

In shutdown, the current consumption of the device is reduced to 0.02 μ A typically.

9 Application and Implementation

9.1 Application Information

The TPS7A8101-Q1 device belongs to a family of new-generation LDO regulators that use innovative circuitry to achieve wide bandwidth and high loop gain, resulting in extremely high PSRR (over a 1-MHz range) even with very low headroom ($V_I - V_O$). A noise-reduction capacitor ($C_{(NR)}$) at the NR pin and a bypass capacitor ($C_{(BYPASS)}$) decrease noise generated by the bandgap reference in order to improve PSRR, while a quick-start circuit fast-charges the noise-reduction capacitor. This family of regulators offers sub-bandgap output voltages, current-limit, and thermal protection, and is fully specified from -40°C to 125°C .

9.2 Typical Application

Figure 31 shows the connections for the device.

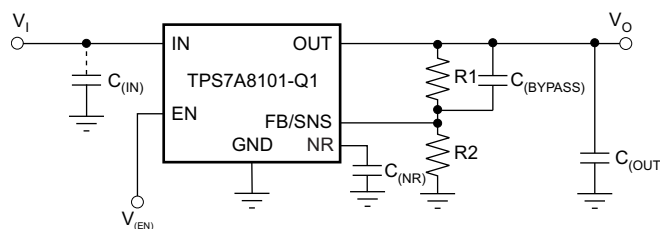

Figure 31. Typical Application Circuit

The voltage on the FB pin sets the output voltage and is determined by the values of the resistors R1 and R2. Use Equation 2 to calculate the values of R1 and R2 any voltage.

$$V_O = \frac{(R1+R2)}{R2} \times 0.8 \quad (2)$$

Table 1 lists sample resistor values for common output voltages. In Table 1, E96 series resistors are used, and all values meet 1% of the target V_O , assuming resistors with zero error. For the actual design, pay attention to any resistor error-factors. Using lower values for R1 and R2 reduces the noise injected into the FB pin.

9.2.1 Design Requirements

9.2.1.1 Dropout Voltage

The TPS7A8101-Q1 device uses a PMOS pass transistor to achieve low dropout. When $(V_I - V_{Onom})$ is less than the dropout voltage (V_{DO}), the PMOS pass device is in the linear region of operation and the input-to-output resistance is the $r_{DS(on)}$ of the PMOS pass element. V_{DO} is proportional to the output current because the PMOS device in dropout functions in the same way as a resistor.

As with any linear regulator, PSRR and transient responses are degraded as $(V_I - V_O)$ approaches dropout. Figure 19 and Figure 20 in the *Typical Characteristics* section shown this effect.

9.2.1.2 Minimum Load

The TPS7A8101-Q1 device is stable and functions well with no output load. Traditional PMOS-LDO regulators suffer from lower loop gain at very light output loads. The TPS7A8101-Q1 device employs an innovative low-current mode circuit to increase loop gain under very light or no-load conditions, resulting in improved output voltage regulation performance down to zero output current.

9.2.1.3 Input And Output Capacitor Requirements

Although an input capacitor is not required for stability, connecting a 0.1- μF to 1- μF low-equivalent series-resistance (ESR) capacitor from the input supply near the regulator to ground is good analog-design practice. This capacitor counteracts reactive input sources and improves transient response and ripple rejection. A higher-value capacitor may be necessary if large, fast load transients are anticipated or if the device is located several inches from the power source. If source impedance is not sufficiently low, a 0.1- μF input capacitor may be necessary to ensure stability.

Typical Application (continued)

The TPS7A8101-Q1 device is designed to be stable with standard ceramic capacitors of capacitance values 4.7 μF or larger. This device was evaluated using a 10- μF ceramic capacitor of 10-V rating, 10% tolerance, X5R type, and 0805 size (2 mm \times 1,25 mm).

X5R-type and X7R-type capacitors are highly recommended because they have minimal variation in capacitance and ESR over temperature. The maximum ESR should be less than 1 Ω .

Table 1. Recommended Feedback Resistor Values for Common Output Voltages

V_O	R1	R2
0.8 V	0 Ω (Short)	10 k Ω
1 V	2.49 k Ω	10 k Ω
1.2 V	4.99 k Ω	10 k Ω
1.5 V	8.87 k Ω	10 k Ω
1.8 V	12.5 k Ω	10 k Ω
2.5 V	21 k Ω	10 k Ω
3.3 V	30.9 k Ω	10 k Ω
5 V	52.3 k Ω	10 k Ω

Table 2. Recommended Capacitor Values

NAME	DESCRIPTION	VALUE
$C_{(NR)}$	Noise-reduction capacitor between the NR and GND pins	470 nF
$C_{(BYPASS)}$	Noise-reduction capacitor across R1	470 nF
$C_{(OUTPUT)}$	Output capacitor	10 μF
$C_{(IN)}$	Input capacitor	10 μF

9.2.1.4 Transient Response

As with any regulator, increasing the size of the output capacitor reduces overshoot and undershoot magnitude but increases the duration of the transient response. Using a larger noise-reduction capacitor ($C_{(NR)}$), bypass capacitor ($C_{(BYPASS)}$), or both types of capacitors can improve line-transient performance.

9.2.2 Detailed Design Procedure

9.2.2.1 Output Noise

In most LDOs, the bandgap is the dominant noise source. If a noise reduction capacitor ($C_{(NR)}$) is used with the TPS7A8101-Q1 device, the bandgap does not contribute significantly to noise. Instead, noise is dominated by the output resistor-divider and the error-amplifier input. If a bypass capacitor ($C_{(BYPASS)}$) across the high-side feedback resistor (R1) is used with the TPS7A8101-Q1 device, noise from these other sources can also be significantly reduced.

To maximize noise performance in a given application, use a 0.47- μF noise-reduction capacitor plus a 0.47- μF bypass capacitor.

9.2.3 Application Curves

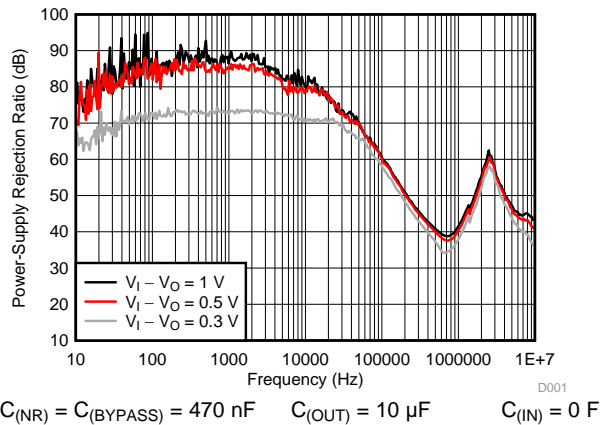

Figure 32. PSRR vs Frequency

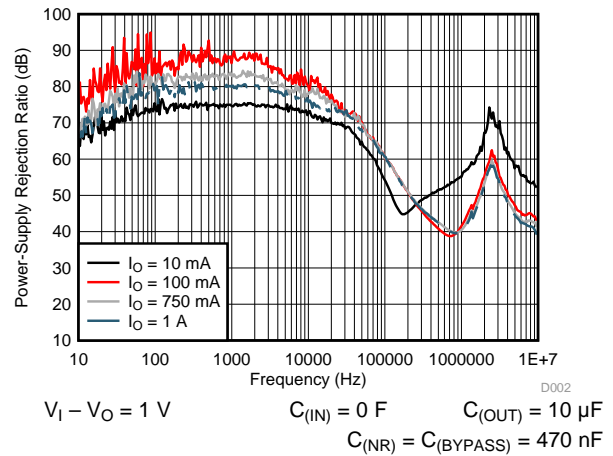

Figure 33. PSRR vs Frequency

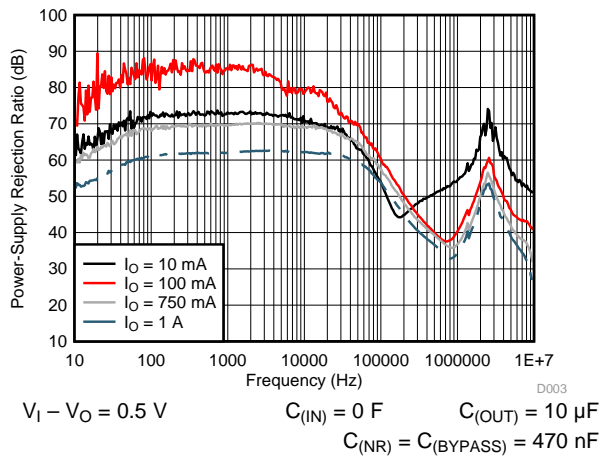

Figure 34. PSRR vs Frequency

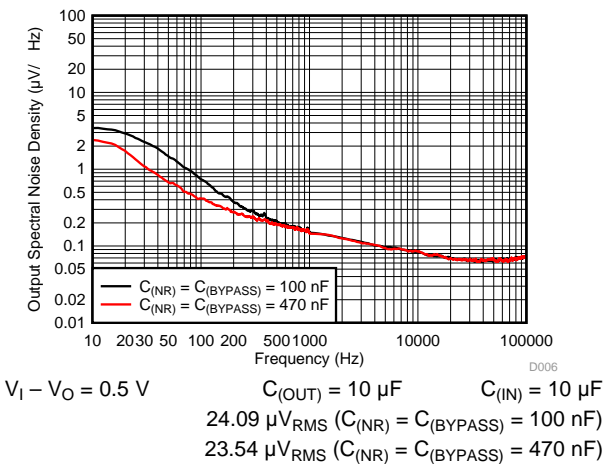

Figure 35. Output Spectral Noise Density vs Frequency (RMS noise (100 Hz to 100 kHz))

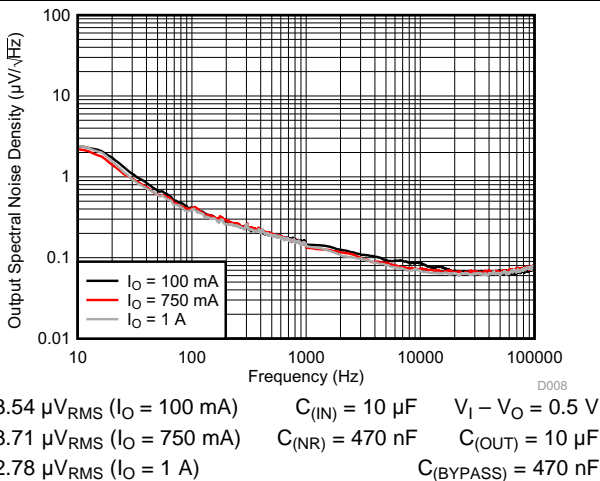

Figure 36. Output Spectral Noise Density vs Frequency (RMS noise (100 Hz to 100 kHz))

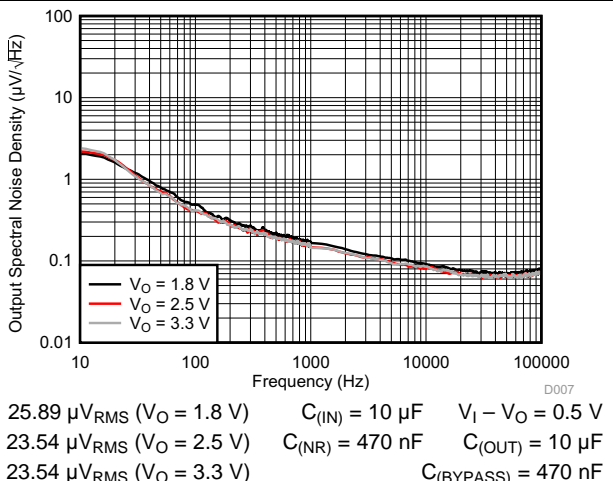
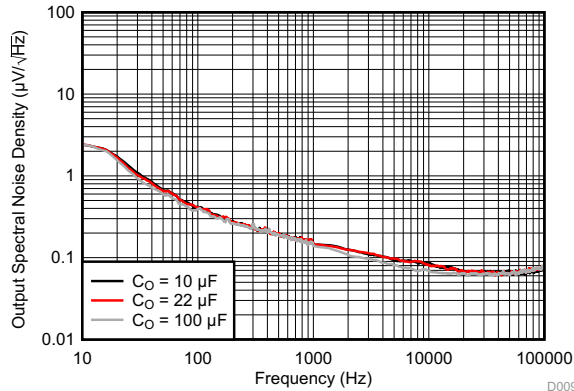
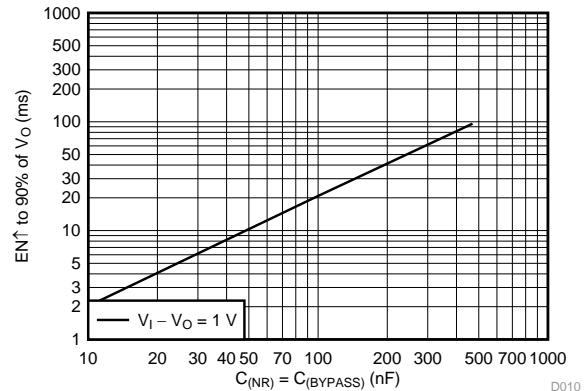

Figure 37. Output Spectral Noise Density vs Frequency (RMS noise (100 Hz to 100 kHz))



23.54 μV_{RMS} ($C_{\text{O}} = 10 \mu\text{F}$) $C_{(\text{IN})} = 10 \mu\text{F}$ $V_{\text{I}} - V_{\text{O}} = 0.5 \text{ V}$
 23.91 μV_{RMS} ($C_{\text{O}} = 22 \mu\text{F}$) $C_{(\text{NR})} = 470 \text{ nF}$ $C_{(\text{OUT})} = 10 \mu\text{F}$
 22.78 μV_{RMS} ($C_{\text{O}} = 100 \mu\text{F}$) $C_{(\text{BYPASS})} = 470 \text{ nF}$

Figure 38. Output Spectral Noise Density vs Frequency (RMS noise (100 Hz to 100 kHz))



Using the same value of $C_{(\text{NR})}$ and $C_{(\text{BYPASS})}$ in the X-Axis

Figure 39. Startup Time vs Noise Reduction Capacitance

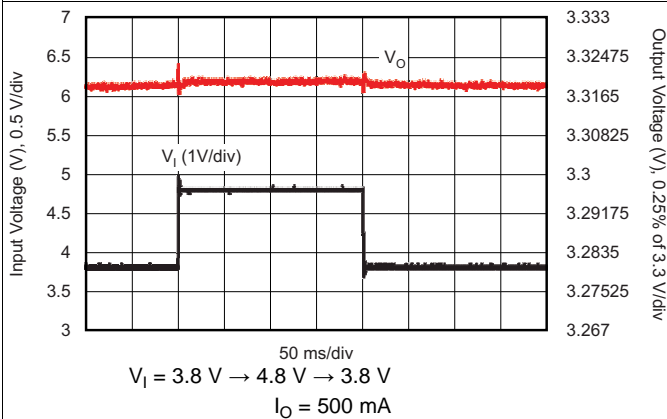

$V_{\text{I}} = 3.8 \text{ V} \rightarrow 4.8 \text{ V} \rightarrow 3.8 \text{ V}$
 $I_{\text{O}} = 500 \text{ mA}$

Figure 40. Line Transient Response

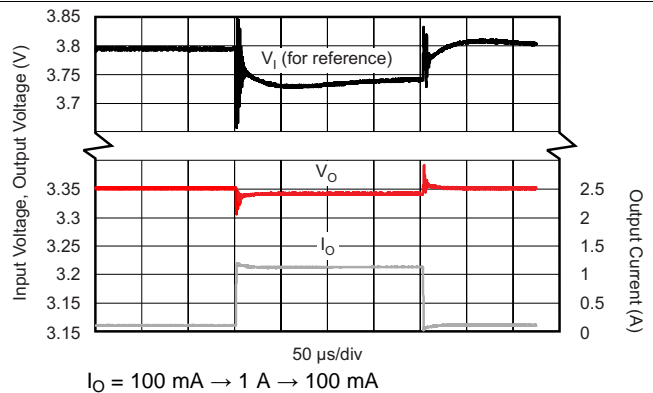

$I_{\text{O}} = 100 \text{ mA} \rightarrow 1 \text{ A} \rightarrow 100 \text{ mA}$

Figure 41. Load Transient Response

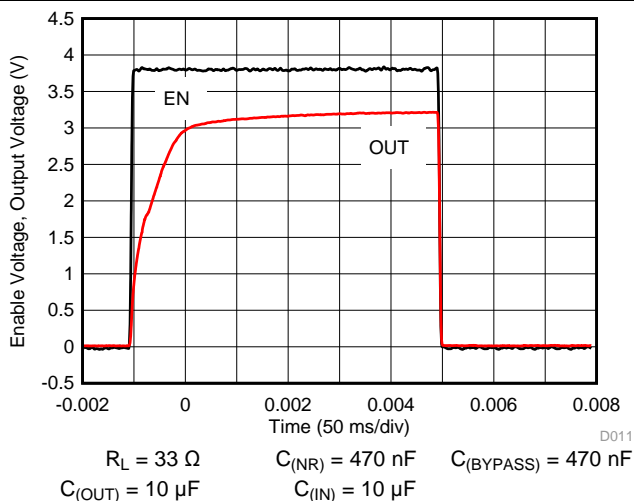

$R_{\text{L}} = 33 \Omega$ $C_{(\text{NR})} = 470 \text{ nF}$ $C_{(\text{BYPASS})} = 470 \text{ nF}$
 $C_{(\text{OUT})} = 10 \mu\text{F}$ $C_{(\text{IN})} = 10 \mu\text{F}$

Figure 42. Enable Pulse Response, See (1) in Figure 43

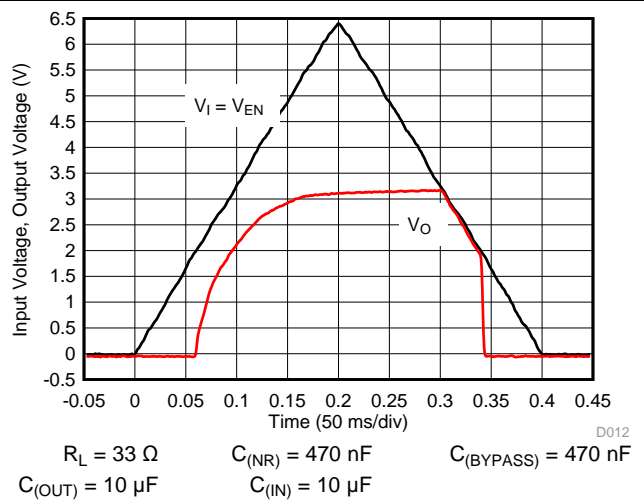

$R_{\text{L}} = 33 \Omega$ $C_{(\text{NR})} = 470 \text{ nF}$ $C_{(\text{BYPASS})} = 470 \text{ nF}$
 $C_{(\text{OUT})} = 10 \mu\text{F}$ $C_{(\text{IN})} = 10 \mu\text{F}$

(1) The internal reference requires approximately 80 ms of rampup time (see Startup) from the enable event; therefore, V_{O} fully reaches the target output voltage of 3.3 V in 80 ms from startup.

Figure 43. Power-Up and Power-Down Response

10 Power Supply Recommendations

The device is designed to operate from an input voltage supply range between 2.2 V and 6.5 V. The input voltage range should provide adequate headroom in order for the device to have a regulated output. This input supply should be well regulated. If the input supply is noisy, additional input capacitors with low ESR can help improve the output noise performance.

11 Layout

11.1 Layout Guidelines

11.1.1 Board Layout Recommendations To Improve PSRR And Noise Performance

To improve AC performance such as PSRR, output noise, and transient response, designing with separate ground planes for V_I and V_O , with each ground plane connected only at the GND pin of the device, is recommended. In addition, the ground connection for the noise-reduction capacitor should connect directly to the GND pin of the device.

High ESR capacitors may degrade PSRR.

11.2 Layout Example

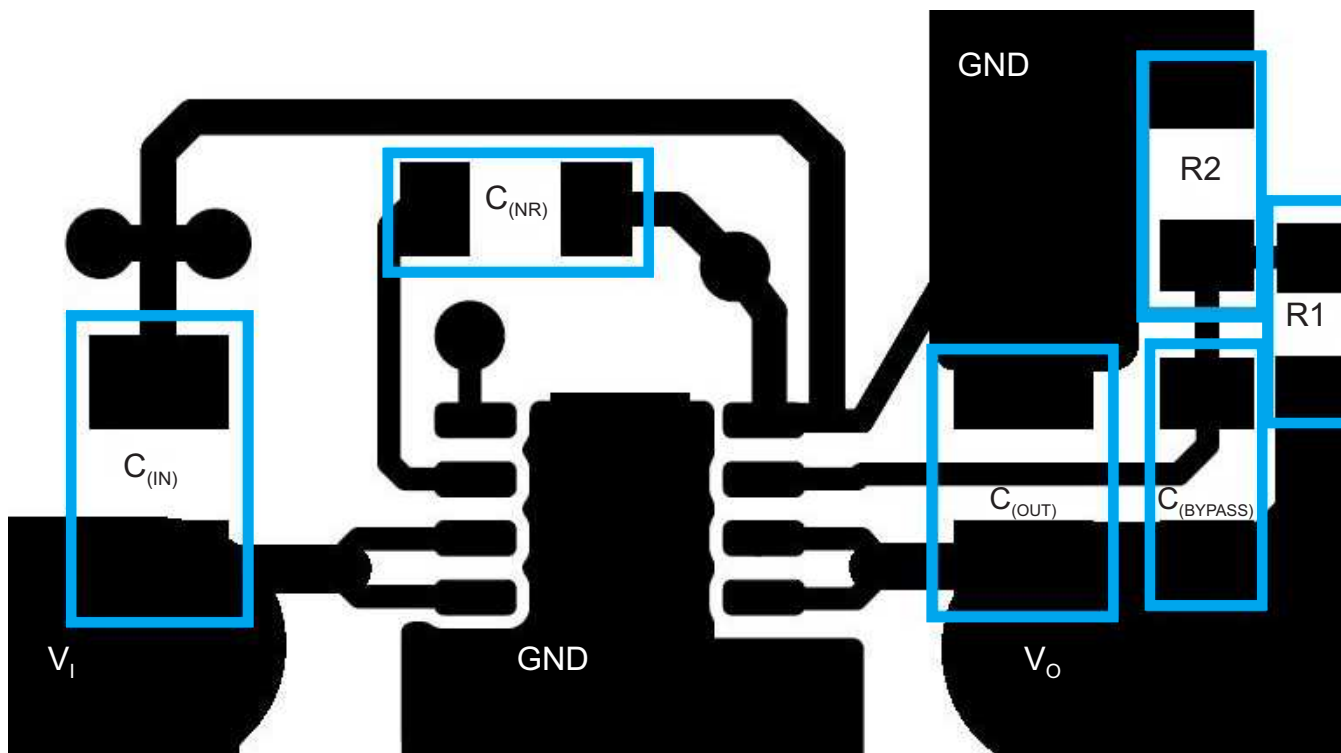

Figure 44. TPS7A8101-Q1 Layout Example

11.3 Thermal Information

11.3.1 Thermal Protection

Thermal protection disables the output when the junction temperature rises to approximately 160°C, allowing the device to cool. When the junction temperature cools to approximately 140°C the output circuitry is again enabled. Depending on power dissipation, thermal resistance, and ambient temperature, the thermal protection circuit may cycle on and off. This cycling limits the dissipation of the regulator, protecting it from damage because of overheating.

Any activation of the thermal protection circuit indicates excessive power dissipation or an inadequate heatsink. For reliable operation, junction temperature should be limited to 125°C (maximum). To estimate the margin of safety in a complete design (including heatsink), increase the ambient temperature until the thermal protection is triggered; use worst-case loads and signal conditions. For good reliability, thermal protection should trigger at least 35°C above the maximum expected ambient condition of your particular application. This configuration produces a worst-case junction temperature of 125°C at the highest expected ambient temperature and worst-case load.

The internal protection circuitry of the TPS7A8101-Q1 device has been designed to protect against overload conditions. The internal thermal protection circuitry was not intended to replace proper heatsinking. Continuously running the TPS7A8101-Q1 device into thermal shutdown degrades device reliability.

11.3.2 Package Mounting

See the [Mechanical, Packaging, and Orderable Information](#) section for solder pad footprint recommendations and recommended land patterns.

11.3.3 Power Dissipation

Knowing the device power dissipation and proper sizing of the thermal plane that is connected to the tab or pad is critical to avoiding thermal shutdown and ensuring reliable operation.

The power dissipation of the device depends on input voltage and load conditions. To calculate the device power dissipation, use [Equation 3](#).

$$P_D = (V_I - V_O) \times I_O \quad (3)$$

Using the lowest possible input voltage necessary to achieve the required output voltage regulation minimizes power dissipation and achieves greater efficiency.

On the SON (DRB) package, the primary conduction path for heat is through the exposed pad to the printed circuit board (PCB). The pad can be connected to ground or can be left floating; however, the pad should be attached to an appropriate amount of copper PCB area to ensure the device does not overheat. The maximum junction-to-ambient thermal resistance depends on the maximum ambient temperature, maximum device junction temperature, and power dissipation of the device. Calculate the maximum junction-to-ambient thermal resistance using [Equation 4](#).

$$R_{\theta JA} = \frac{(125^\circ\text{C} - T_A)}{P_D} \quad (4)$$

Once the maximum $R_{\theta JA}$ value is calculated, use [Figure 45](#) to estimate the minimum amount of PCB copper area needed for appropriate heatsinking.

Thermal Information (continued)

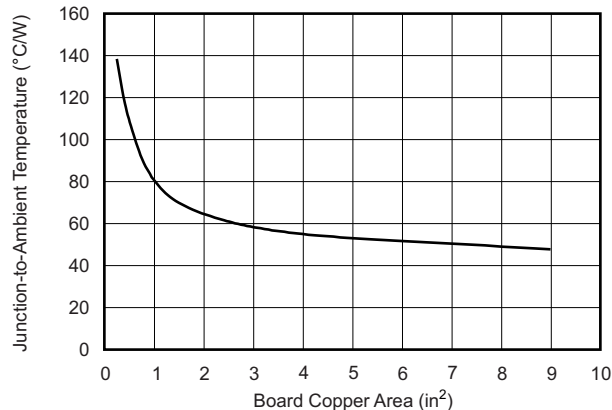

Note: The $R_{\theta JA}$ value at board size of 9 in² (that is, 3 in × 3 in) is a JEDEC standard.

Figure 45. $R_{\theta JA}$ vs Board Size

Figure 45 shows the variation of $R_{\theta JA}$ as a function of ground plane copper area in the board. Figure 45 is intended as a guideline only to demonstrate the effects of heat spreading in the ground plane and should not be used to estimate actual thermal performance in real application environments.

NOTE

When the device is mounted on an application PCB, using Ψ_{JT} and Ψ_{JB} , as explained in the section is strongly recommended.

11.3.4 Estimating Junction Temperature

Using the thermal metrics Ψ_{JT} and Ψ_{JB} , as shown in the *Thermal Information* table, the junction temperature can be estimated with the corresponding equations, Equation 5 and Equation 6. For backwards compatibility, an older $\theta_{JC, Top}$ parameter is listed as well.

$$\phi_{JT}: T_J = T_T + \phi_{JT} \times P_D$$

where

- P_D is the power dissipation (see Equation 4)
- T_T is the temperature at the center-top of the IC package (5)

$$\phi_{JB}: T_J = T_B + \phi_{JB} \times P_D$$

where

- T_B is the PCB temperature measured 1-mm away from the IC package on the PCB surface as shown in Figure 46 (6)

Thermal Information (continued)

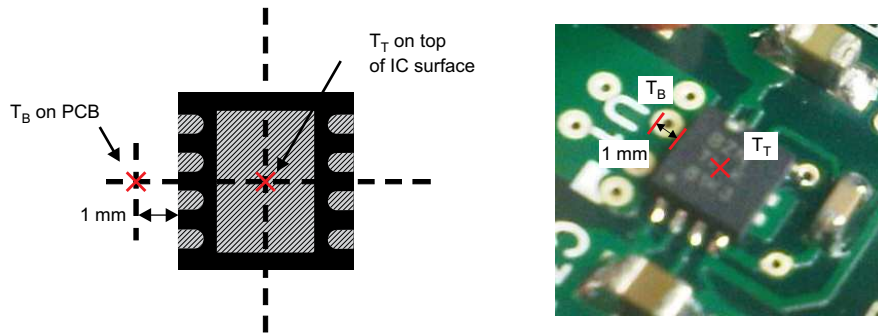

Figure 46. Measuring Points for T_T and T_B

NOTE

Both T_T and T_B can be measured on actual application boards using an infrared thermometer.

For more information about measuring T_T and T_B , see TI's application report [SBVA025](#), *Using New Thermal Metrics*.

As shown in [Figure 47](#), the new thermal metrics (Ψ_{JT} and Ψ_{JB}) have very little dependency on board size. That is, using Ψ_{JT} or Ψ_{JB} with [Equation 5](#) is a good way to estimate T_J by simply measuring T_T or T_B , regardless of the application board size.

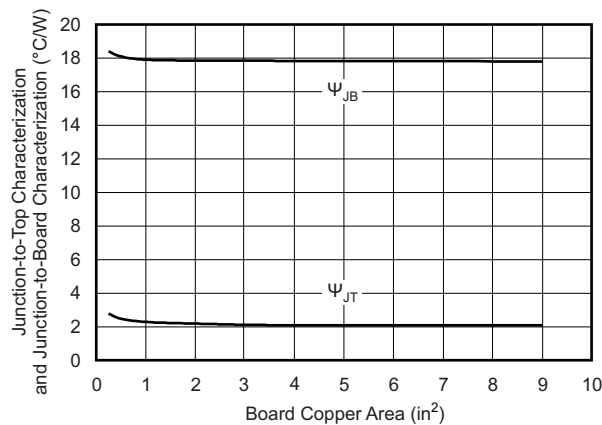

Figure 47. Ψ_{JT} and Ψ_{JB} vs Board Size

For a more detailed discussion of why TI does not recommend using $R_{\theta JC(top)}$ to determine thermal characteristics, refer to TI's application report [SBVA025](#), *Using New Thermal Metrics*. For further information, refer to TI's application report [SPRA953](#), *IC Package Thermal Metrics*.

12 Device and Documentation Support

12.1 Documentation Support

12.1.1 Related Documentation

For related documentation see the following:

- *LDO noise examined in detail*, [SLYT489](#)
- *LDO Performance Near Dropout*, [SBVA029](#)
- *TPS7A8101EVM Evaluation Module*, [SLVU600](#)
- *Wide Bandwidth PSRR of LDOs* by Nogawa and Van Renterghem in *Bodo's Power Systems®: Electronics in Motion and Conversion*, March 2011

12.2 Trademarks

Bodo's Power Systems is a registered trademark of Arlt Bodo.
All other trademarks are the property of their respective owners.

12.3 Electrostatic Discharge Caution



This integrated circuit can be damaged by ESD. Texas Instruments recommends that all integrated circuits be handled with appropriate precautions. Failure to observe proper handling and installation procedures can cause damage.

ESD damage can range from subtle performance degradation to complete device failure. Precision integrated circuits may be more susceptible to damage because very small parametric changes could cause the device not to meet its published specifications.

12.4 Glossary

[SLYZ022](#) — *TI Glossary*.

This glossary lists and explains terms, acronyms, and definitions.

13 Mechanical, Packaging, and Orderable Information

The following pages include mechanical, packaging, and orderable information. This information is the most current data available for the designated devices. This data is subject to change without notice and revision of this document. For browser-based versions of this data sheet, refer to the left-hand navigation.

PACKAGING INFORMATION

Orderable Device	Status (1)	Package Type	Package Drawing	Pins	Package Qty	Eco Plan (2)	Lead finish/ Ball material (6)	MSL Peak Temp (3)	Op Temp (°C)	Device Marking (4/5)	Samples
TPS7A8101QDRBRQ1	ACTIVE	SON	DRB	8	3000	RoHS & Green	NIPDAU	Level-2-260C-1 YEAR	-40 to 125	SLY	Samples

(1) The marketing status values are defined as follows:

ACTIVE: Product device recommended for new designs.

LIFEBUY: TI has announced that the device will be discontinued, and a lifetime-buy period is in effect.

NRND: Not recommended for new designs. Device is in production to support existing customers, but TI does not recommend using this part in a new design.

PREVIEW: Device has been announced but is not in production. Samples may or may not be available.

OBSOLETE: TI has discontinued the production of the device.

(2) **RoHS:** TI defines "RoHS" to mean semiconductor products that are compliant with the current EU RoHS requirements for all 10 RoHS substances, including the requirement that RoHS substance do not exceed 0.1% by weight in homogeneous materials. Where designed to be soldered at high temperatures, "RoHS" products are suitable for use in specified lead-free processes. TI may reference these types of products as "Pb-Free".

RoHS Exempt: TI defines "RoHS Exempt" to mean products that contain lead but are compliant with EU RoHS pursuant to a specific EU RoHS exemption.

Green: TI defines "Green" to mean the content of Chlorine (Cl) and Bromine (Br) based flame retardants meet JS709B low halogen requirements of <=1000ppm threshold. Antimony trioxide based flame retardants must also meet the <=1000ppm threshold requirement.

(3) MSL, Peak Temp. - The Moisture Sensitivity Level rating according to the JEDEC industry standard classifications, and peak solder temperature.

(4) There may be additional marking, which relates to the logo, the lot trace code information, or the environmental category on the device.

(5) Multiple Device Markings will be inside parentheses. Only one Device Marking contained in parentheses and separated by a "-" will appear on a device. If a line is indented then it is a continuation of the previous line and the two combined represent the entire Device Marking for that device.

(6) Lead finish/Ball material - Orderable Devices may have multiple material finish options. Finish options are separated by a vertical ruled line. Lead finish/Ball material values may wrap to two lines if the finish value exceeds the maximum column width.

Important Information and Disclaimer: The information provided on this page represents TI's knowledge and belief as of the date that it is provided. TI bases its knowledge and belief on information provided by third parties, and makes no representation or warranty as to the accuracy of such information. Efforts are underway to better integrate information from third parties. TI has taken and continues to take reasonable steps to provide representative and accurate information but may not have conducted destructive testing or chemical analysis on incoming materials and chemicals. TI and TI suppliers consider certain information to be proprietary, and thus CAS numbers and other limited information may not be available for release.

In no event shall TI's liability arising out of such information exceed the total purchase price of the TI part(s) at issue in this document sold by TI to Customer on an annual basis.

OTHER QUALIFIED VERSIONS OF TPS7A8101-Q1 :

- Catalog: [TPS7A8101](#)

NOTE: Qualified Version Definitions:

- Catalog - TI's standard catalog product

TAPE AND REEL INFORMATION



QUADRANT ASSIGNMENTS FOR PIN 1 ORIENTATION IN TAPE



*All dimensions are nominal

Device	Package Type	Package Drawing	Pins	SPQ	Reel Diameter (mm)	Reel Width W1 (mm)	A0 (mm)	B0 (mm)	K0 (mm)	P1 (mm)	W (mm)	Pin1 Quadrant
TPS7A8101QDRBRQ1	SON	DRB	8	3000	330.0	12.4	3.3	3.3	1.1	8.0	12.0	Q2

TAPE AND REEL BOX DIMENSIONS



*All dimensions are nominal

Device	Package Type	Package Drawing	Pins	SPQ	Length (mm)	Width (mm)	Height (mm)
TPS7A8101QDRBRQ1	SON	DRB	8	3000	367.0	367.0	35.0

DRB 8

GENERIC PACKAGE VIEW

VSON - 1 mm max height

PLASTIC SMALL OUTLINE - NO LEAD

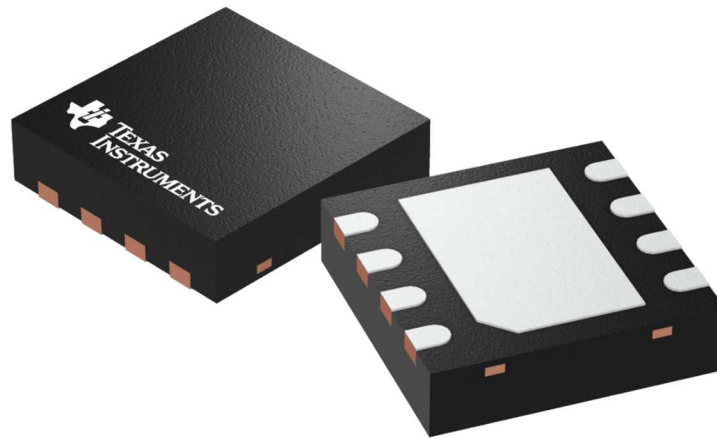

Images above are just a representation of the package family, actual package may vary.
Refer to the product data sheet for package details.

4203482/L

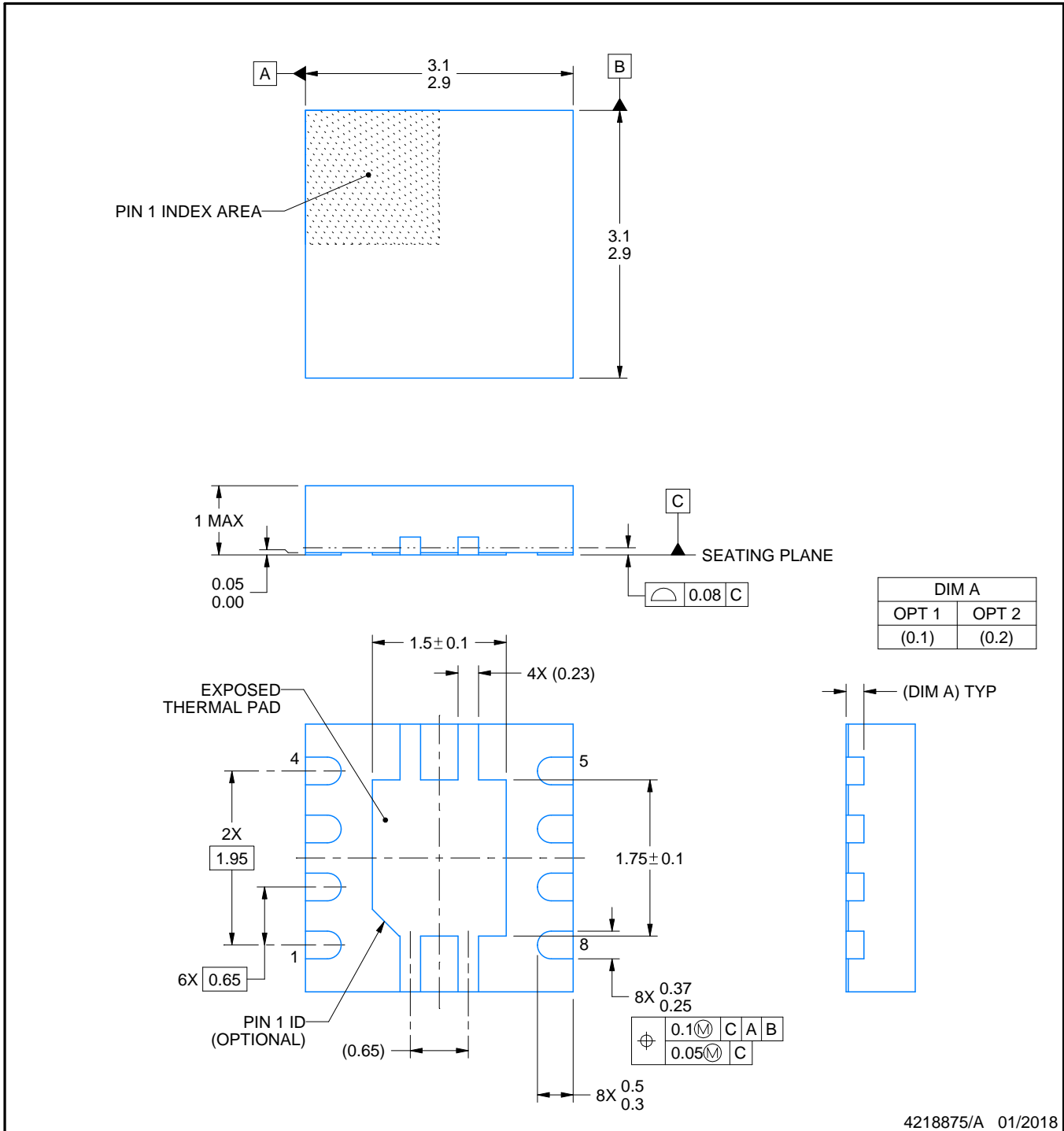

4218875/A 01/2018

NOTES:

1. All linear dimensions are in millimeters. Any dimensions in parenthesis are for reference only. Dimensioning and tolerancing per ASME Y14.5M.
2. This drawing is subject to change without notice.
3. The package thermal pad must be soldered to the printed circuit board for thermal and mechanical performance.

EXAMPLE BOARD LAYOUT

DRB0008A

VSON - 1 mm max height

PLASTIC SMALL OUTLINE - NO LEAD

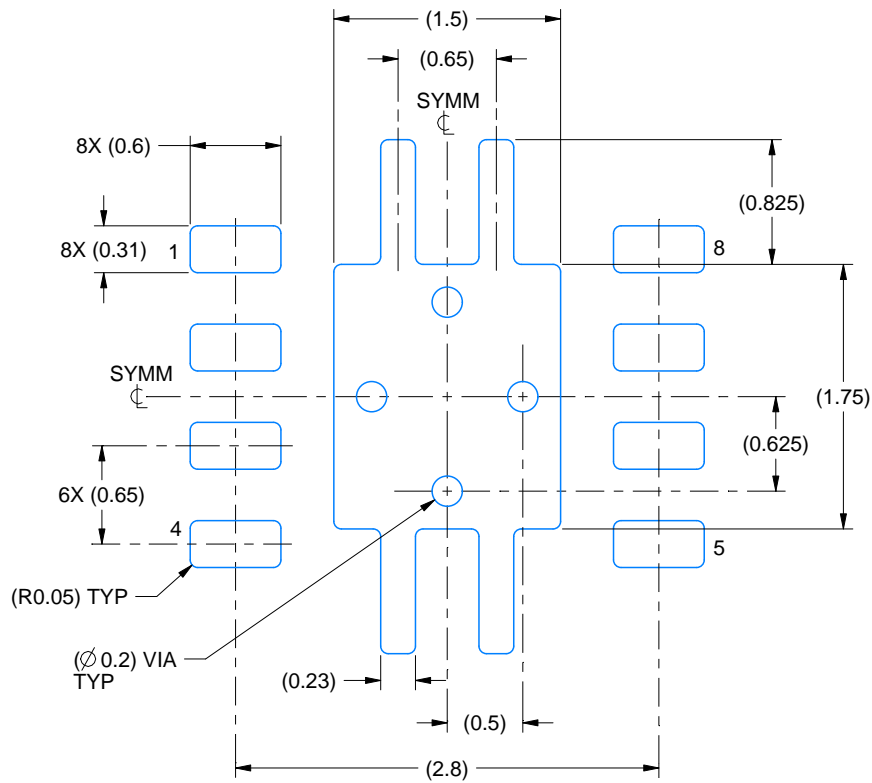

LAND PATTERN EXAMPLE
EXPOSED METAL SHOWN
SCALE:20X

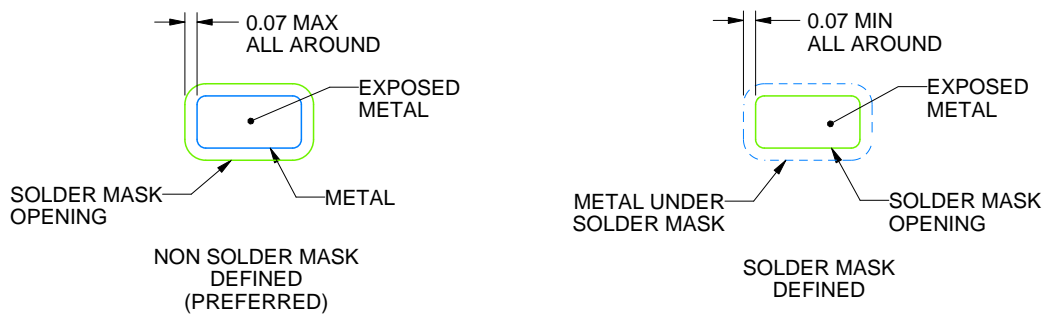

SOLDER MASK DETAILS

4218875/A 01/2018

NOTES: (continued)

4. This package is designed to be soldered to a thermal pad on the board. For more information, see Texas Instruments literature number SLUA271 (www.ti.com/lit/slua271).
5. Vias are optional depending on application, refer to device data sheet. If any vias are implemented, refer to their locations shown on this view. It is recommended that vias under paste be filled, plugged or tented.

EXAMPLE STENCIL DESIGN

DRB0008A

VSON - 1 mm max height

PLASTIC SMALL OUTLINE - NO LEAD

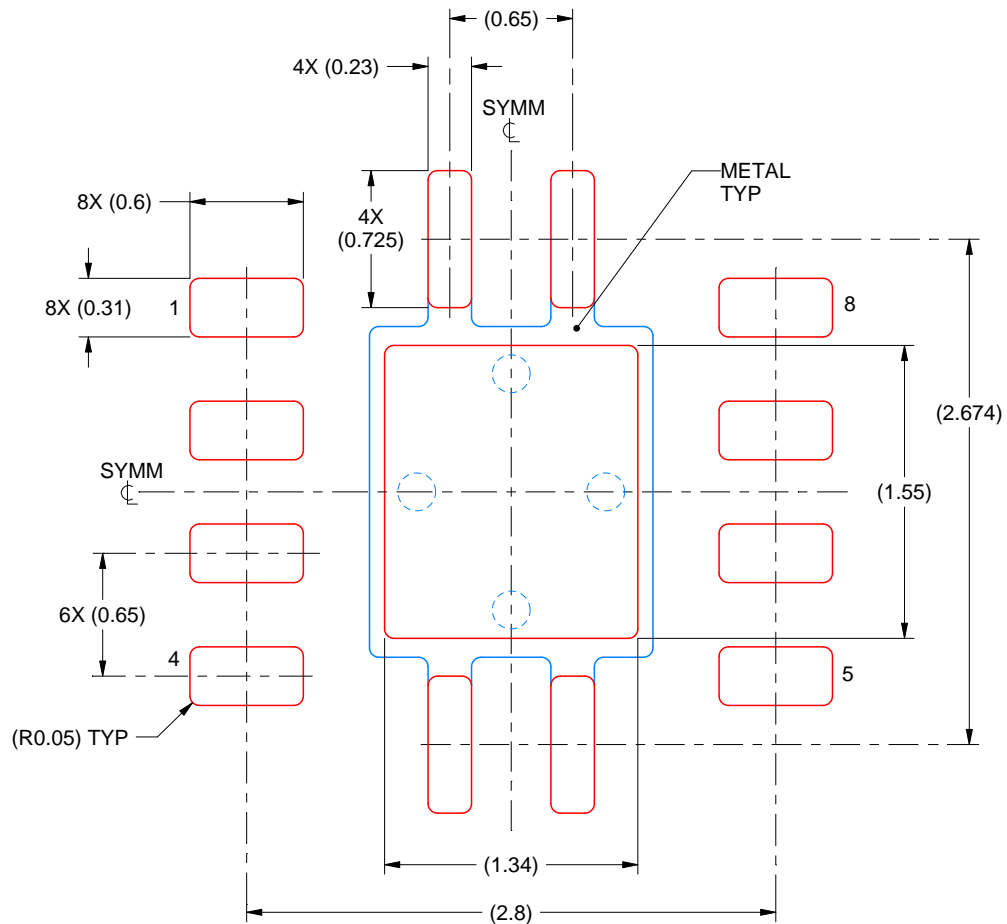

SOLDER PASTE EXAMPLE
BASED ON 0.125 mm THICK STENCIL

EXPOSED PAD
84% PRINTED SOLDER COVERAGE BY AREA
SCALE:25X

4218875/A 01/2018

NOTES: (continued)

6. Laser cutting apertures with trapezoidal walls and rounded corners may offer better paste release. IPC-7525 may have alternate design recommendations.

IMPORTANT NOTICE AND DISCLAIMER

TI PROVIDES TECHNICAL AND RELIABILITY DATA (INCLUDING DATASHEETS), DESIGN RESOURCES (INCLUDING REFERENCE DESIGNS), APPLICATION OR OTHER DESIGN ADVICE, WEB TOOLS, SAFETY INFORMATION, AND OTHER RESOURCES "AS IS" AND WITH ALL FAULTS, AND DISCLAIMS ALL WARRANTIES, EXPRESS AND IMPLIED, INCLUDING WITHOUT LIMITATION ANY IMPLIED WARRANTIES OF MERCHANTABILITY, FITNESS FOR A PARTICULAR PURPOSE OR NON-INFRINGEMENT OF THIRD PARTY INTELLECTUAL PROPERTY RIGHTS.

These resources are intended for skilled developers designing with TI products. You are solely responsible for (1) selecting the appropriate TI products for your application, (2) designing, validating and testing your application, and (3) ensuring your application meets applicable standards, and any other safety, security, or other requirements. These resources are subject to change without notice. TI grants you permission to use these resources only for development of an application that uses the TI products described in the resource. Other reproduction and display of these resources is prohibited. No license is granted to any other TI intellectual property right or to any third party intellectual property right. TI disclaims responsibility for, and you will fully indemnify TI and its representatives against, any claims, damages, costs, losses, and liabilities arising out of your use of these resources.

TI's products are provided subject to TI's Terms of Sale (www.ti.com/legal/termsofsale.html) or other applicable terms available either on ti.com or provided in conjunction with such TI products. TI's provision of these resources does not expand or otherwise alter TI's applicable warranties or warranty disclaimers for TI products.

Mailing Address: Texas Instruments, Post Office Box 655303, Dallas, Texas 75265
Copyright © 2020, Texas Instruments Incorporated