

Click to view price, real time Inventory,  
Delivery & Lifecycle Information ;

## AP2280-2WG-7

Diodes Incorporated

Power Switch ICs - Power Distribution Programmable Load Switch  
1.5V - 6V

Any questions, please feel free to contact us.  
[info@kaimte.com](mailto:info@kaimte.com)

### Features

- Wide input voltage range: 1.5V – 6V
- Low  $R_{DS(ON)}$ : 80m $\Omega$  typical @ 5V
- Turn-on slew rate controlled
- AP2280-1: 100us turn-on rise time
- AP2280-2: 1ms turn-on rise time
- Very low turn-on quiescent current:  $\ll$  1uA
- Fast load discharge pin
- Temperature range -40°C to 85°C
- SOT25 and DFN2018-6: Available in "Green" Molding Compound (No Br, Sb)
- Lead Free Finish/ RoHS Compliant (Note 1)

### Description

The AP2280 slew rate controlled load switch is a single P-channel MOSFET power switch designed for high-side load-switching or power distribution applications. The MOSFET has a typical  $R_{DS(ON)}$  of 80m $\Omega$  at 5V, allowing increased load current handling capability with a low forward voltage drop. The turn-on slew rate of the device is controlled internally to reduce turn-on inrush current.





The AP2280 load switch is designed to operate from 1.5V to 6.0V, making it ideal for 1.8V, 2.5V, 3.3V, and 5V systems. The typical quiescent supply current is only 0.004uA, making it ideal for battery powered distribution system where the power consumption is a concern.

### Applications

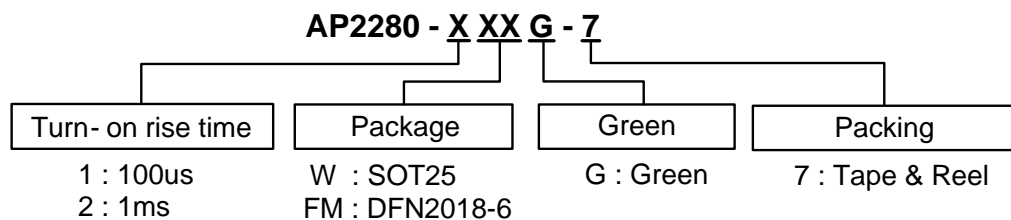
- Smart Phones
- Personal Digital Assistant (PDA)
- Cell Phones
- GPS Navigators
- Bluetooth Headsets
- PMP/MP4
- Notebook and Pocket PC

### Ordering Information



Device	Package Code	Packaging (Note 2)	7" Tape and Reel	
			Quantity	Part Number Suffix
 AP2280-1WG-7	W	SOT25	3000/Tape & Reel	-7
 AP2280-2WG-7	W	SOT25	3000/Tape & Reel	-7
 AP2280-1FMG-7	FM	DFN2018-6	3000/Tape & Reel	-7
 AP2280-2FMG-7	FM	DFN2018-6	3000/Tape & Reel	-7

Notes: 1. EU Directive 2002/95/EC (RoHS). All applicable RoHS exemptions applied. Please visit our website at [http://www.diodes.com/products/lead\\_free.html](http://www.diodes.com/products/lead_free.html).  
 2. Pad layout as shown on Diodes Inc. suggested pad layout document AP02001, which can be found on our website at <http://www.diodes.com/datasheets/ap02001.pdf>.

### Pin Assignments

(1) SOT25

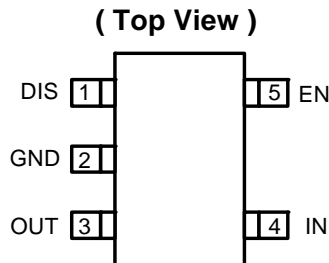

(2) DFN2018-6

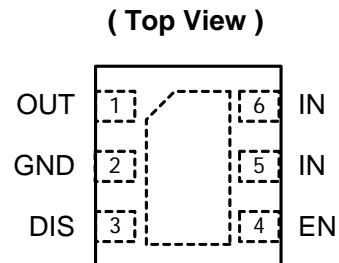

### Pin Description

Pin Name	Pin Number		Description
	SOT25	DFN2018-6	
DIS	1	3	Discharge pin. If DIS pin is tied to OUT pin externally, the output voltage will be discharged to ground when disabled.
GND	2	2	Ground.
OUT	3	1	Voltage output pin. This is the pin to the P-channel MOSFET drain. Bypass to ground through a 0.1uF capacitor.
IN	4	5, 6	Voltage input pin. This is the pin to the P-channel MOSFET source. Bypass to ground through a 1µF capacitor.
EN	5	4	Enable input, active high

### Block Diagram

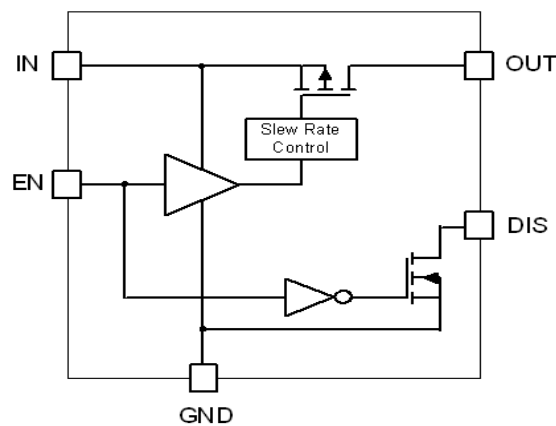

### Typical Application Circuits

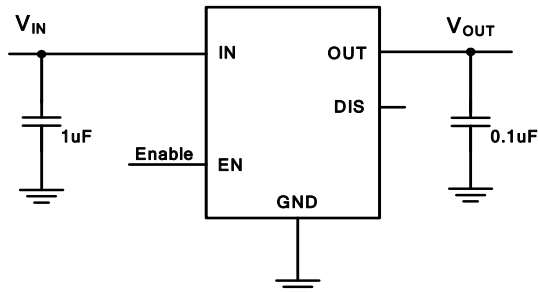

For applications without output discharge

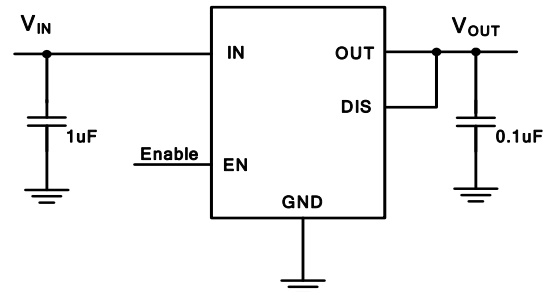

For applications with output discharge

### Absolute Maximum Ratings

Symbol	Parameter	Ratings	Units
ESD HBM	Human Body Model ESD Protection	4	KV
ESD MM	Machine Model ESD Protection	400	V
$V_{IN}$	Input Voltage	6.5	V
$V_{OUT}$	Output Voltage	$V_{IN} + 0.3$	V
$V_{EN}$	Enable Voltage	6.5	V
$I_{load}$	Maximum Continuous Load Current	2	A
$T_{J(max)}$	Maximum Junction Temperature	125	°C
$T_{ST}$	Storage Temperature Range	-65 ~ 150	°C
$P_D$	Power Dissipation	SOT25 (Note 3, 5)	750
		DFN2018-6 (Note 3, 6)	1260

Notes: 3. Ratings apply to ambient temperature at 25°C

### Recommended Operating Conditions

Symbol	Parameter	Min	Max	Units
$V_{IN}$	Input voltage	1.5	6.0	V
$I_{OUT}$	Output Current (Note 4)	0	2.0	A
$T_A$	Operating Ambient Temperature	-40	85	°C

Notes: 4. Maximum output current depends on application conditions. Please refer to the application note section.

**Electrical Characteristics**

( $T_A = 25^\circ\text{C}$ ,  $V_{IN} = V_{EN} = 5.0\text{V}$ , unless otherwise stated)

Symbol	Parameters	Test Conditions	Min	Typ.	Max	Unit
$I_Q$	Input Quiescent Current	$V_{EN} = V_{IN}$ , $I_{OUT} = 0$	—	0.004	1	$\mu\text{A}$
$I_{SHDN}$	Input Shutdown Current	$V_{EN} = 0\text{V}$ , OUT open	—	0.004	1	$\mu\text{A}$
$I_{LEAK}$	Input Leakage Current	$V_{EN} = 0\text{V}$ , OUT grounded	—	0.01	1	$\mu\text{A}$
$R_{DS(ON)}$	Switch on-resistance	$V_{IN} = 5.0\text{V}$		80	105	$\text{m}\Omega$
		$V_{IN} = 3.3\text{V}$		92	120	$\text{m}\Omega$
		$V_{IN} = 1.8\text{V}$		150	200	$\text{m}\Omega$
		$V_{IN} = 1.5\text{V}$		200	250	$\text{m}\Omega$
$V_{IL}$	EN Input Logic Low Voltage	$V_{IN} = 1.5\text{V to } 6\text{V}$			0.4	V
$V_{IH}$	EN Input Logic High Voltage	$1.5\text{V} \leq V_{IN} \leq 2.7\text{V}$	1.4			V
		$2.7\text{V} < V_{IN} < 5.25\text{V}$	1.6			V
		$V_{IN} \geq 5.25\text{V}$	1.7			V
$I_{SINK}$	EN Input leakage	$V_{EN} = 5\text{V}$	—		1	$\mu\text{A}$
$T_{D(ON)}$	Output turn-on delay time	$R_{load} = 10\Omega$		1		$\mu\text{S}$
$T_{ON}$	Output turn-on rise time	AP2280-1, $R_{load} = 10\Omega$		100	150	$\mu\text{S}$
		AP2280-2, $R_{load} = 10\Omega$		1000	1500	$\mu\text{S}$
$T_{D(OFF)}$	Output turn-off delay time	$R_{load} = 10\Omega$		0.4	1	$\mu\text{S}$
$R_{DISCH}$	Discharge FET on-resistance	$V_{EN} = \text{GND}$		20	40	$\Omega$
$\theta_{JA}$	Thermal Resistance Junction-to-Ambient	SOT25 (Note 5)		160		$^\circ\text{C/W}$
		DFN2018-6 (Note 6)		93		$^\circ\text{C/W}$
$\theta_{JC}$	Thermal Resistance Junction-to-case	SOT25 (Note 5)		38		$^\circ\text{C/W}$
		DFN2018-6 (Note 6)		41		$^\circ\text{C/W}$

Notes: 5. Test condition for SOT25: Device mounted on FR-4 substrate PC board, with minimum recommended pad layout.

6. Test condition for DFN2018-6: Device mounted on FR-4 2-layer board, 2oz copper, with minimum recommended pad on top layer and 3 vias to bottom layer 1.0"x1.4" ground plane.

**Typical Performance Characteristics**

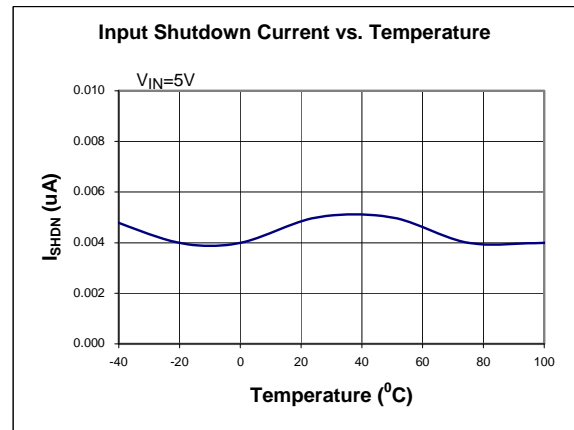
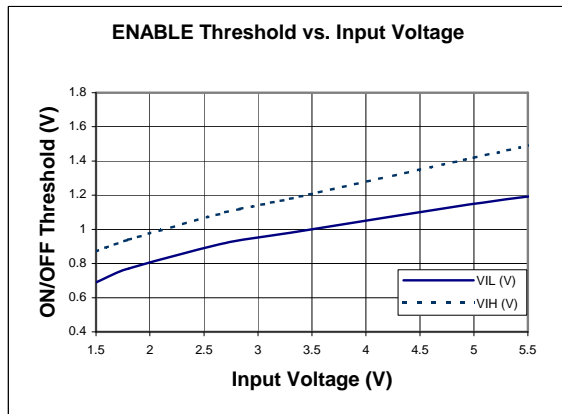
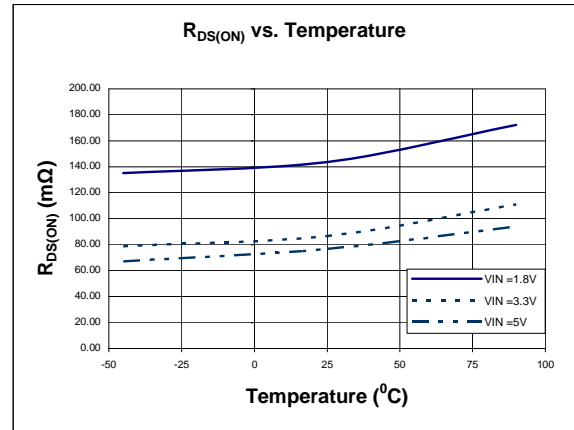
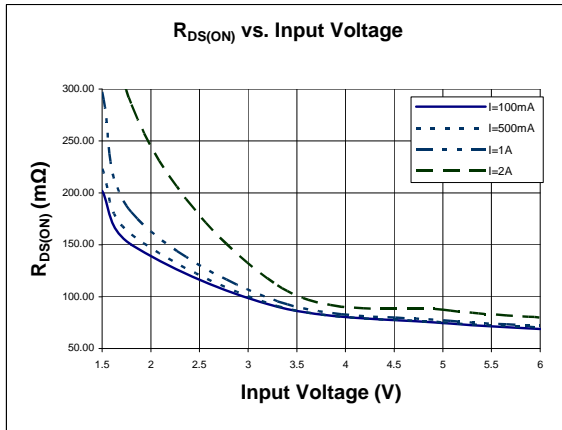
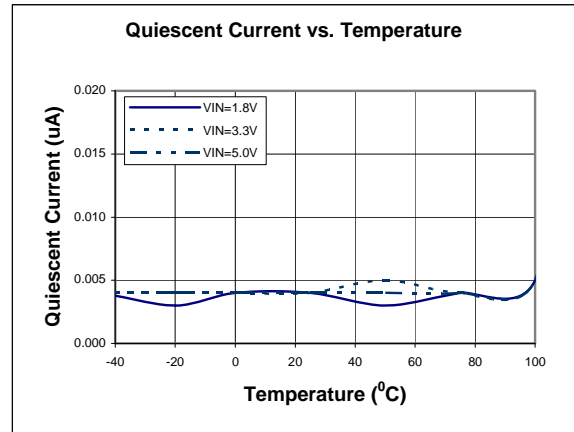
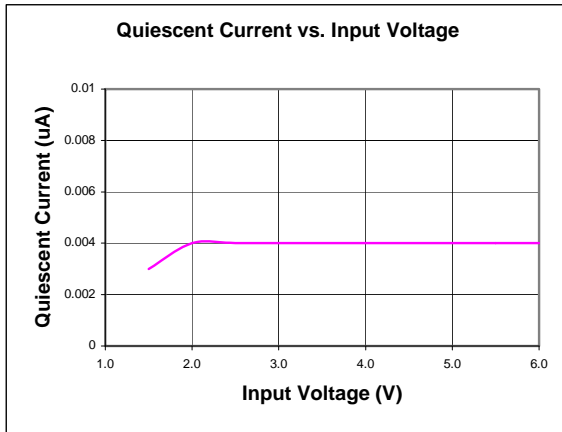

**Typical Performance Characteristics (Continued)**

**AP2280-1 Turn-On**  
( $V_{IN}=3.3V, R_L=7\Omega$ )



Time (50μs/div)

**AP2280-1 Turn-Off**  
( $V_{IN}=3.3V, R_L=7\Omega$ )

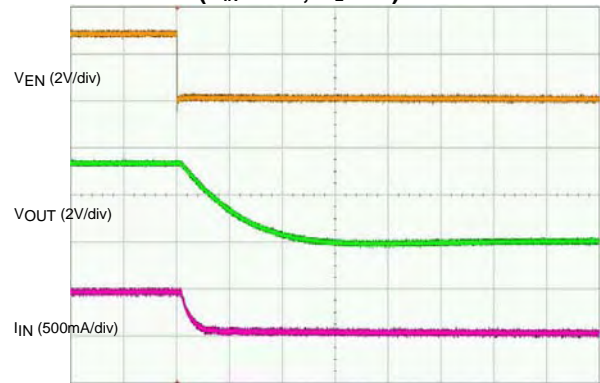

Time (5μs/div)

**AP2280-1 Turn-On**  
( $V_{IN}=5V, R_L=10\Omega$ )

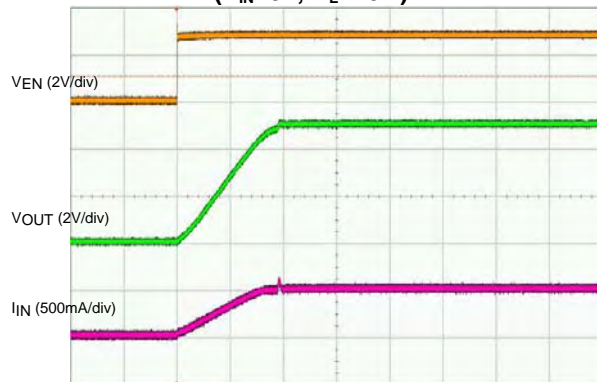

Time (50μs/div)

**AP2280-1 Turn-Off**  
( $V_{IN}=5V, R_L=10\Omega$ )

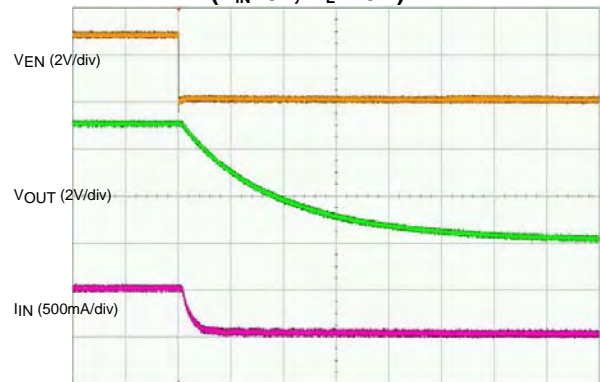

Time (5μs/div)

**Typical Performance Characteristics (Continued)**

**AP2280-2 Turn-On**  
( $V_{IN}=3.3V$ ,  $R_L=7\Omega$ )



Time (500µs/div)

**AP2280-2 Turn-Off**  
( $V_{IN}=3.3V$ ,  $R_L=7\Omega$ )

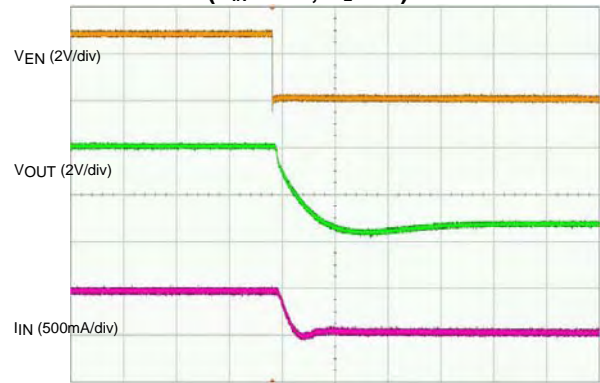

Time (5µs/div)

**AP2280-2 Turn-On**  
( $V_{IN}=5V$ ,  $R_L=10\Omega$ )

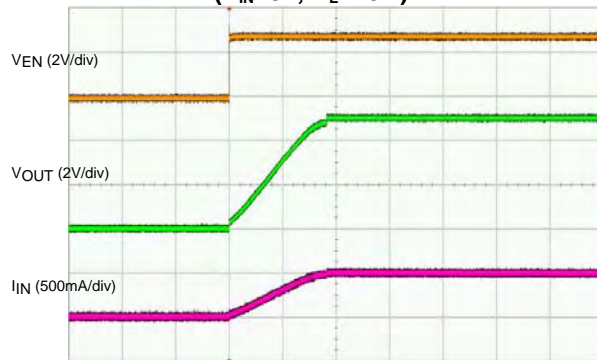

Time (500µs/div)

**AP2280-2 Turn-Off**  
( $V_{IN}=5V$ ,  $R_L=10\Omega$ )

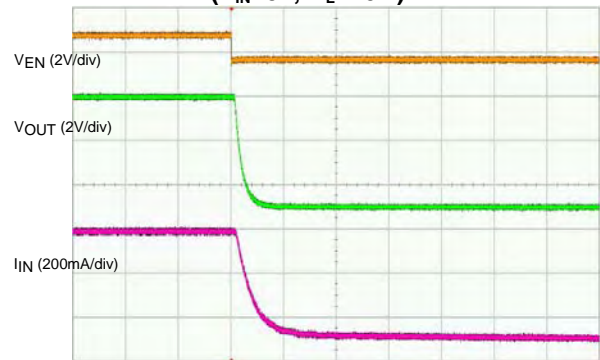

Time (5µs/div)



---

## Application Note

---

### Input Capacitor

A 1 $\mu$ F capacitor is recommended to connect between IN and GND pins to decouple input power supply glitch and noise. The input capacitor has no specific type or ESR (Equivalent Series Resistance) requirement. However, for higher current application, ceramic capacitors are recommended due to their capability to withstand input current surges from low impedance sources, such as batteries in portable applications. This input capacitor must be located as close as possible to the device to assure input stability and less noise. For PCB layout, a wide copper trace is required for both IN and GND.

### Output Capacitor

A 0.1 $\mu$ F capacitor is recommended to connect between OUT and GND pins to stabilize and accommodate load transient condition. The output capacitor has no specific type or ESR requirement. The amount of the capacitance may be increased without limit. For PCB layout, the output capacitor must be placed as close as possible to OUT and GND pins, and keep the traces as short as possible.

### Enable/Shutdown Operation

The AP2280 is turned on by setting the EN pin high, and is turned off by pulling it low. To ensure proper operation, the signal source used to drive the EN pin must be able to swing above and below the specified turn-on/off voltage thresholds listed in the Electrical Characteristics section under  $V_{IL}$  and  $V_{IH}$ .

### Discharge Operation

The AP2280 offers discharge option that helps to discharge the output when disabled. To use this feature, the DIS pin is connected to OUT pin externally. If this feature is not used, the DIS pin should be left open.

### Power Dissipation

The device power dissipation and proper sizing of the thermal plane is critical to avoid thermal shutdown and ensuring reliable operation. Power dissipation of the device depends on input voltage and load conditions and can be calculated by:

$$P_D = I_{OUT}^2 \times R_{DS(on)} \quad (1)$$

However, the maximum power dissipation that can be handled by the device depends on the maximum junction to ambient thermal resistance, maximum ambient temperature, and maximum device junction temperature, which can be approximated by the equation below:

$$P_D(\text{max}@T_A) = \frac{(+125^\circ\text{C} - T_A)}{\theta_{JA}} \quad (2)$$

For example at  $V_{IN}=5\text{V}$ , the typical  $R_{DS(on)} = 80\text{m}\Omega$ . For  $I_{OUT}=2\text{A}$ , the maximum power dissipation calculated using equation (1) is  $P_D=0.32\text{W}$ . Based on  $\theta_{JA}=160^\circ\text{C/W}$  and equation (2), the calculated junction temperature rise from ambient is approximately  $51^\circ\text{C}$ . Since the maximum junction temperature is  $125^\circ\text{C}$ , the operating ambient temperature must be kept below  $74^\circ\text{C}$  to safely operate the device.

On the other hand, at  $T_A=85^\circ\text{C}$  and  $V_{IN}=5\text{V}$ , the calculated maximum power dissipation from equation (2) is  $P_{Dmax}=0.25\text{W}$ . Hence the safe operating maximum continuous current is  $1.77\text{A}$ . For other application conditions, the users should recalculate the device maximum power dissipation based on the operating conditions.

### Marking Information

(1) SOT25

( Top View )

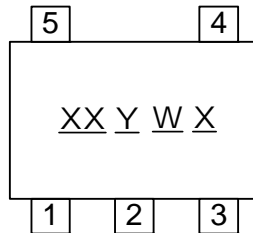

XX : Identification code  
Y : Year 0~9  
W : Week : A~Z : 1~26 week;  
a~z : 27~52 week; z represents  
52 and 53 week  
X : A~Z : Green

Device	Package type	Identification Code
AP2280-1W	SOT25	UA
AP2280-2W	SOT25	UB

(2) DFN2018-6

( Top View )

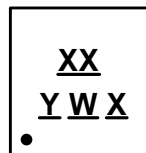

XX : Identification code  
Y : Year 0~9  
W : Week : A~Z : 1~26 week;  
a~z : 27~52 week; z represents  
52 and 53 week  
X : A~Z : Green

Device	Package type	Identification Code
AP2280-1FM	DFN2018-6	UC
AP2280-2FM	DFN2018-6	UD

**Package Information** (All Dimensions in mm)

(1) Package type: SOT25

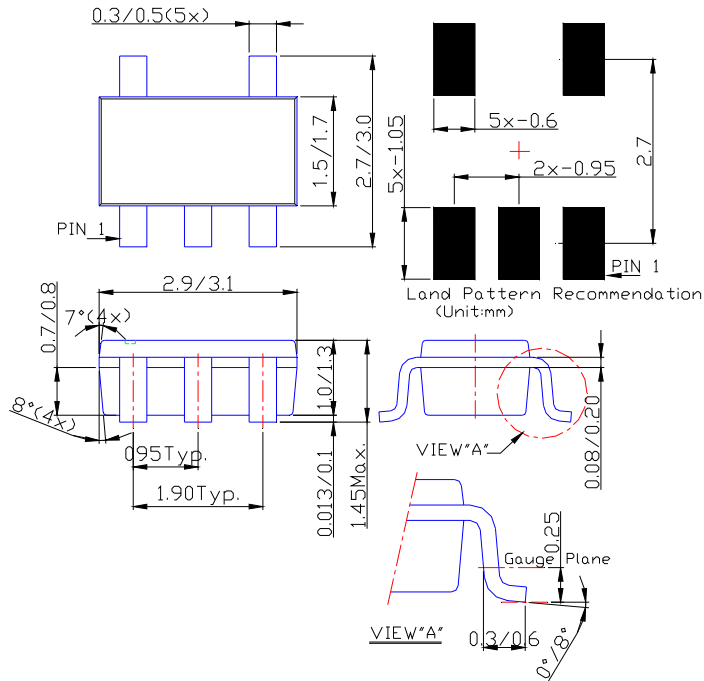

**Package Information (Continued)**

(2) Package type: DFN2018-6

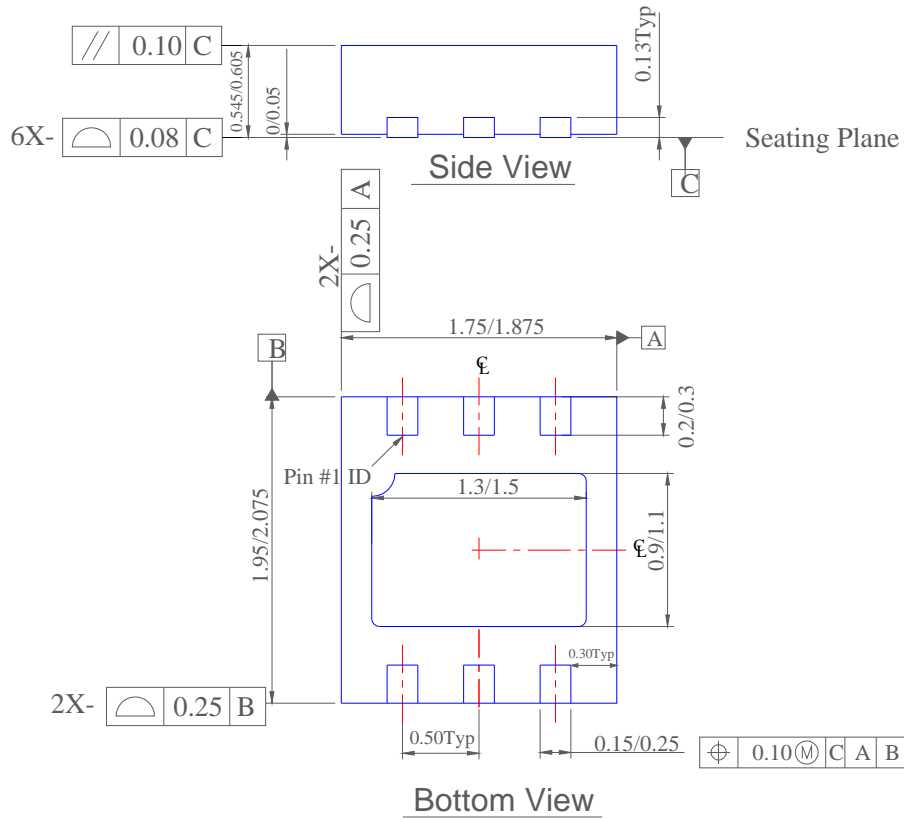

**Taping Orientation**

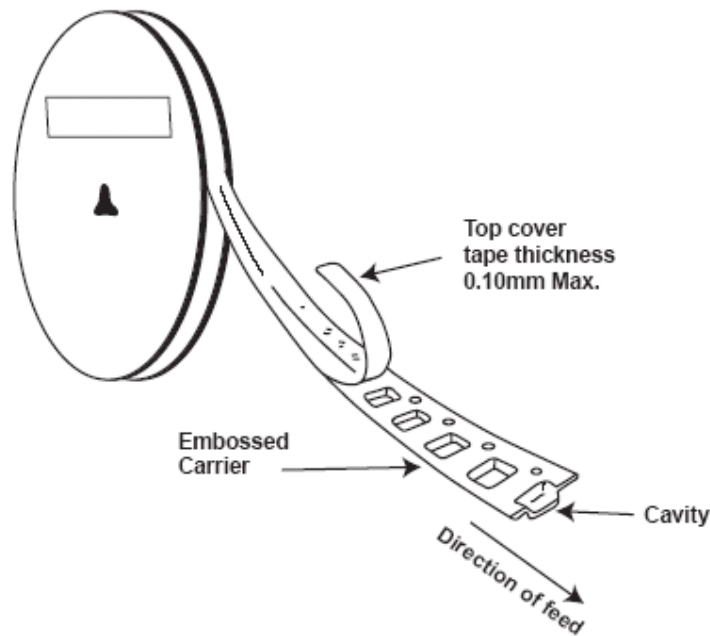
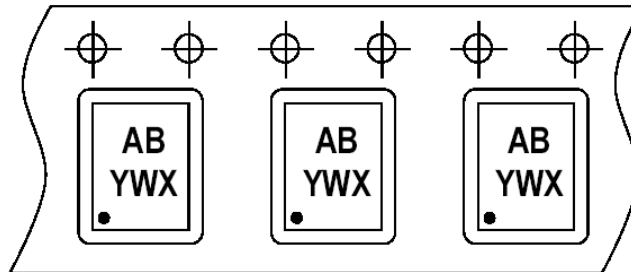

Notes: 7. The taping orientation of the other package type can be found on our website at <http://www.diodes.com/datasheets/ap02007.pdf>.

**IMPORTANT NOTICE**

Diodes Incorporated and its subsidiaries reserve the right to make modifications, enhancements, improvements, corrections or other changes without further notice to any product herein. Diodes Incorporated does not assume any liability arising out of the application or use of any product described herein; neither does it convey any license under its patent rights, nor the rights of others. The user of products in such applications shall assume all risks of such use and will agree to hold Diodes Incorporated and all the companies whose products are represented on our website, harmless against all damages.

**LIFE SUPPORT**

Diodes Incorporated products are not authorized for use as critical components in life support devices or systems without the expressed written approval of the President of Diodes Incorporated.

# Mouser Electronics

Authorized Distributor

Click to View Pricing, Inventory, Delivery & Lifecycle Information:

[Diodes Incorporated:](#)

[AP2280-1WG-7](#) [AP2280-1FMG-7](#) [AP2280-2WG-7](#) [AP2280-2FMG-7](#)