

Click to view price, real time Inventory,
Delivery & Lifecycle Information ;

HMC586LC4BTR

Analog Devices

VCO Oscillators

Any questions, please feel free to contact us.
info@kaimte.com



WIDEBAND MMIC VCO w/ BUFFER AMPLIFIER, 4 - 8 GHz

Typical Applications

Low Noise wideband MMIC VCO is ideal for:

- Industrial/Medical Equipment
- Test & Measurement Equipment
- Military Radar, EW & ECM

Features

- Wide Tuning Bandwidth
- Output: +5 dBm
- Low SSB Phase Noise: -100 dBc/Hz @100 kHz
- No External Resonator Needed
- Single Positive Supply: +5V @ 55 mA
- RoHS Compliant 4 x 4 mm SMT Package

Functional Diagram

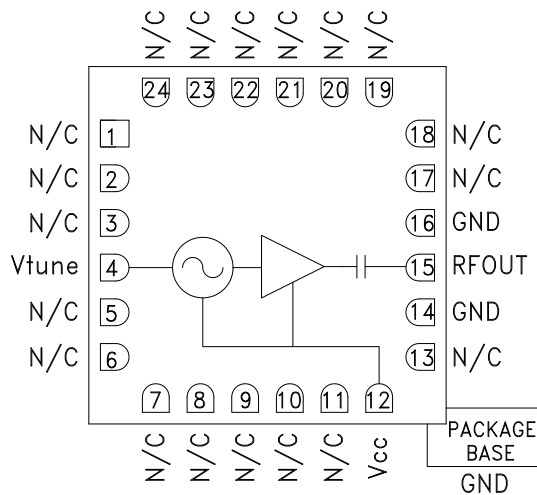

General Description

The HMC586LC4B is a wideband GaAs InGaP Voltage Controlled Oscillator which incorporates the resonator, negative resistance device, and varactor diode. Output power and phase noise performance are excellent over temperature due to the oscillator's monolithic construction. The Vtune port accepts an analog tuning voltage from 0 to +18V. The HMC586LC4B VCO operates from a single +5V supply, consumes only 55 mA of current, and is housed in a RoHS compliant SMT package. This wideband VCO uniquely combines the attributes of ultra small size, low phase noise, low power consumption, and wide tuning range.

Electrical Specifications, $T_A = +25^\circ C$, $V_{CC} = +5V$

| Parameter | Min. | Typ. | Max. | Units |
|--|------|-------|------|-----------------|
| Frequency Range | | 4 - 8 | | GHz |
| Power Output | 2 | 5 | | dBm |
| SSB Phase Noise @ 100 kHz Offset | | -100 | | dBc/Hz |
| SSB Phase Noise @ 10 kHz Offset | | -75 | | dBc/Hz |
| Tune Voltage (Vtune) | 0 | | 18 | V |
| Supply Current (Icc) (Vcc = +5.0V) | 40 | | 75 | mA |
| Tune Port Leakage Current (Vtune = +15V) | | | 10 | μA |
| Output Return Loss | | 7 | | dB |
| 2nd Harmonic | | -14 | | dBc |
| Pulling (into a 2.0:1 VSWR) | | 4 | | MHz pp |
| Pushing @ Vtune = +5V | | 40 | | MHz/V |
| Frequency Drift Rate | | 0.8 | | MHz/ $^\circ C$ |

Information furnished by Analog Devices is believed to be accurate and reliable. However, no responsibility is assumed by Analog Devices for its use, nor for any infringements of patents or other rights of third parties that may result from its use. Specifications subject to change without notice. No license is granted by implication or otherwise under any patent or patent rights of Analog Devices. Trademarks and registered trademarks are the property of their respective owners.

For price, delivery, and to place orders: Analog Devices, Inc., One Technology Way, P.O. Box 9106, Norwood, MA 02062-9106
Phone: 781-329-4700 • Order online at www.analog.com
Application Support: Phone: 1-800-ANALOG-D



WIDEBAND MMIC VCO w/ BUFFER AMPLIFIER, 4 - 8 GHz

Frequency vs. Tuning Voltage, Vcc = +5V

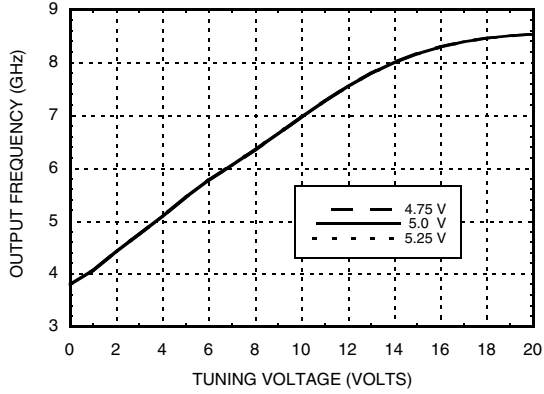

Frequency vs. Tuning Voltage, T = +25 C

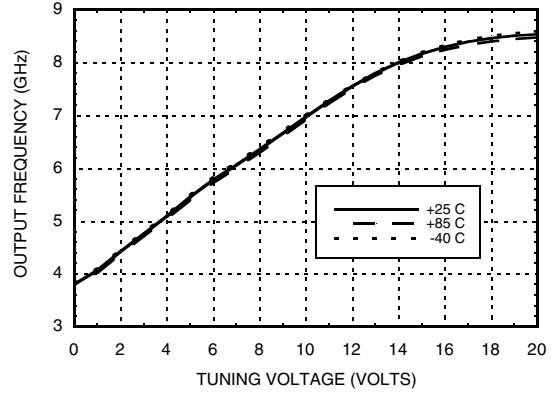

Sensitivity vs. Tuning Voltage, Vcc= +5V

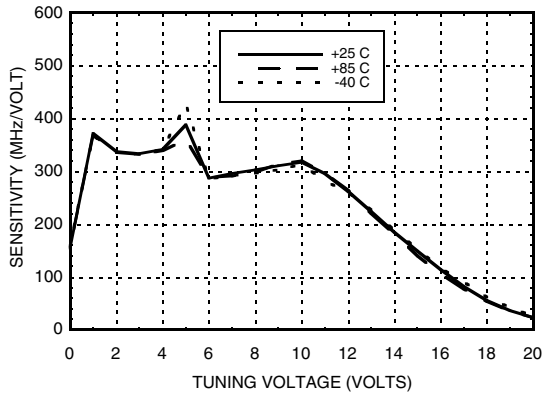

Output Power vs. Tuning Voltage, Vcc= +5V

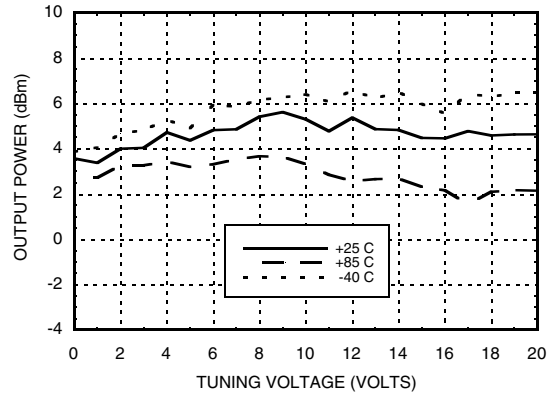

SSB Phase Noise vs. Tuning Voltage

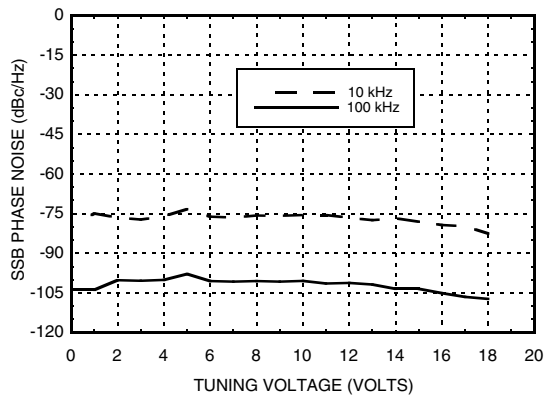

Typical SSB Phase Noise @ Vtune= +5V

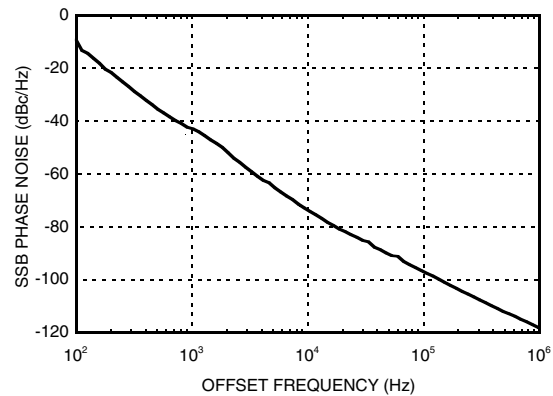

Information furnished by Analog Devices is believed to be accurate and reliable. However, no responsibility is assumed by Analog Devices for its use, nor for any infringements of patents or other rights of third parties that may result from its use. Specifications subject to change without notice. No license is granted by implication or otherwise under any patent or patent rights of Analog Devices. Trademarks and registered trademarks are the property of their respective owners.

For price, delivery, and to place orders: Analog Devices, Inc., One Technology Way, P.O. Box 9106, Norwood, MA 02062-9106 Phone: 781-329-4700 • Order online at www.analog.com Application Support: Phone: 1-800-ANALOG-D



WIDEBAND MMIC VCO w/ BUFFER AMPLIFIER, 4 - 8 GHz

Absolute Maximum Ratings

| | |
|---|----------------|
| Vcc | +5.5 Vdc |
| Vtune | 0 to +22V |
| Junction Temperature | 135 °C |
| Continuous Pdiss (T = 85°C) (derate 12.5 mW/°C above 85°C) | 625 mW |
| Thermal Resistance (junction to ground paddle) | 80 °C/W |
| Storage Temperature | -65 to +150 °C |
| Operating Temperature | -40 to +85 °C |



**ELECTROSTATIC SENSITIVE DEVICE
OBSERVE HANDLING PRECAUTIONS**

Outline Drawing

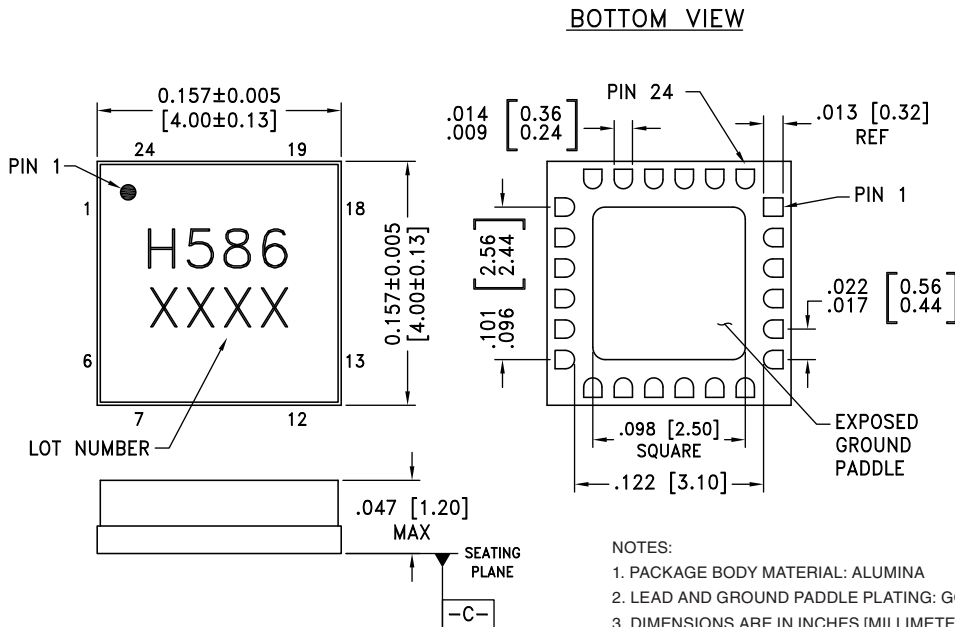

- NOTES:
1. PACKAGE BODY MATERIAL: ALUMINA
 2. LEAD AND GROUND PADDLE PLATING: GOLD FLASH OVER Ni.
 3. DIMENSIONS ARE IN INCHES [MILLIMETERS].
 4. LEAD SPACING TOLERANCE IS NON-CUMULATIVE.
 5. PACKAGE WARP SHALL NOT EXCEED 0.05mm DATUM -C-
 6. ALL GROUND LEADS AND GROUND PADDLE MUST BE SOLDERED TO PCB RF GROUND.

Package Information



| Part Number | Package Body Material | Lead Finish | MSL Rating | Package Marking [2] |
|-------------|-----------------------|------------------|------------|---------------------|
| HMC586LC4B | Alumina, White | Gold over Nickel | MSL3 [1] | H586 XXXX |

[1] Max peak reflow temperature of 260 °C
[2] 4-Digit lot number XXXX

Information furnished by Analog Devices is believed to be accurate and reliable. However, no responsibility is assumed by Analog Devices for its use, nor for any infringements of patents or other rights of third parties that may result from its use. Specifications subject to change without notice. No license is granted by implication or otherwise under any patent or patent rights of Analog Devices. Trademarks and registered trademarks are the property of their respective owners.

For price, delivery, and to place orders: Analog Devices, Inc., One Technology Way, P.O. Box 9106, Norwood, MA 02062-9106 Phone: 781-329-4700 • Order online at www.analog.com Application Support: Phone: 1-800-ANALOG-D

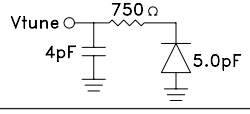
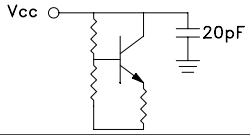

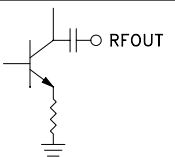
**WIDEBAND MMIC VCO w/ BUFFER
AMPLIFIER, 4 - 8 GHz**
Pin Descriptions

| Pin Number | Function | Description | Interface Schematic |
|----------------------------|----------|---|---|
| 1 - 3, 5 - 11, 13, 17 - 24 | N/C | No Connection. These pins may be connected to RF/DC ground. Performance will not be affected. | |
| 4 | Vtune | Control Voltage and Modulation Input. Modulation bandwidth dependent on drive source impedance. See "Determining the FM Bandwidth of a Wideband Varactor Tuned VCO" application note. |  |
| 12 | Vcc | Supply Voltage Vcc= +5V |  |
| 14, 16 | GND | Package bottom has an exposed metal paddle that must also be RF & DC grounded. |  |
| 15 | RFOUT | RF output (AC coupled) |  |

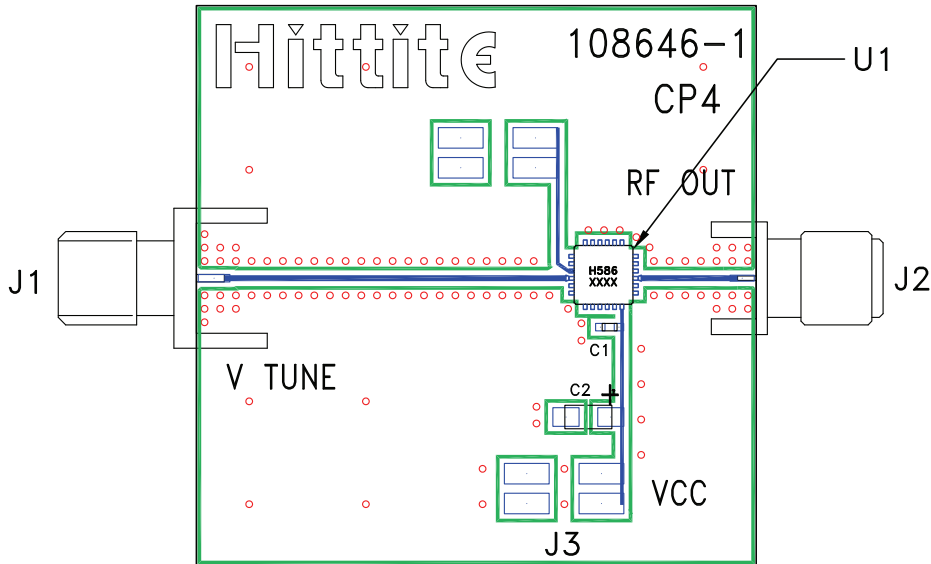

**WIDEBAND MMIC VCO w/ BUFFER
AMPLIFIER, 4 - 8 GHz**

Evaluation PCB



List of Materials for Evaluation PCB 108648 [1]

| Item | Description |
|---------|-------------------------------------|
| J1 | PCB Mount SMA RF Connector, Johnson |
| J2 | PCB Mount SMA Connector, SRI |
| J3 | DC Header |
| C1 | 1000 pF Capacitor, 0402 Pkg. |
| C2 | 4.7 μ F Capacitor, Tantalum |
| U1 | HMC586LC4B VCO |
| PCB [2] | 108646 Eval Board |

[1] Reference this number when ordering complete evaluation PCB
 [2] Circuit Board Material: Rogers 4350

The circuit board used in the application should use RF circuit design techniques. Signal lines should have 50 Ohm impedance while the package ground leads and exposed ground paddle should be connected directly to the ground plane similar to that shown. A sufficient number of via holes should be used to connect the top and bottom ground planes. The evaluation circuit board shown is available from Hittite upon request.

Information furnished by Analog Devices is believed to be accurate and reliable. However, no responsibility is assumed by Analog Devices for its use, nor for any infringements of patents or other rights of third parties that may result from its use. Specifications subject to change without notice. No license is granted by implication or otherwise under any patent or patent rights of Analog Devices. Trademarks and registered trademarks are the property of their respective owners.

For price, delivery, and to place orders: Analog Devices, Inc., One Technology Way, P.O. Box 9106, Norwood, MA 02062-9106 Phone: 781-329-4700 • Order online at www.analog.com Application Support: Phone: 1-800-ANALOG-D

**WIDEBAND MMIC VCO w/ BUFFER
AMPLIFIER, 4 - 8 GHz**