

FEATURES

- Supply current: 1 μ A maximum/amplifier
- Offset voltage: 3 mV maximum
- Single-supply or dual-supply operation
- Rail-to-rail input and output
- No phase reversal
- Unity gain stable

APPLICATIONS

- Portable equipment
- Remote sensors
- Low power filters
- Threshold detectors
- Current sensing

GENERAL DESCRIPTION

The AD8502/AD8504 are low power, precision CMOS operational amplifiers featuring a maximum supply current of 1 μ A per amplifier. The AD8502/AD8504 have a maximum offset voltage of 3 mV and a typical input bias current of 1 pA operating rail-to-rail on both the input and output. The AD8502/AD8504 can operate from a single-supply voltage of +1.8 V to +5.5 V or a dual-supply voltage of ± 0.9 V to ± 2.75 V.

With its low power consumption, low input bias current, and rail-to-rail input and output, the AD8502/AD8504 are ideally suited for a variety of battery-powered portable applications. Potential applications include bedside monitors, pulse monitors, glucose meters, smoke and fire detectors, vibration monitors, and backup battery sensors.

The ability to swing rail-to-rail at both the input and output helps maximize dynamic range and signal-to-noise ratio in systems that operate at very low voltages. The low offset voltage allows use of the AD8502/AD8504 in systems with high gain

PIN CONFIGURATIONS

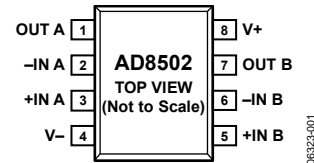

Figure 1. 8-Lead SOT-23

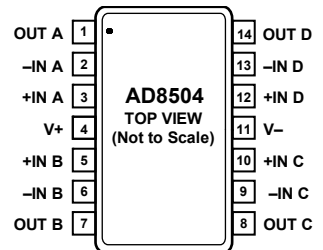

Figure 2. 14-Lead TSSOP (RU-14)

without creating excessively large output offset errors. The AD8502 and AD8504 offer an additional benefit by providing high accuracy without the need for system calibration.

The AD8502/AD8504 are fully specified over the industrial temperature range (-40°C to $+85^{\circ}\text{C}$) and the extended industrial temperature range (-40°C to $+125^{\circ}\text{C}$). The AD8502 is available in an 8-lead, SOT-23 surface-mount package. The AD8504 is available in a 14-lead TSSOP surface-mount package.

Table 1. Low Supply Current Op Amps

Supply Current	1 μ A	10 μ A	20 μ A
Single	AD8500		
Dual	AD8502	ADA4505-2	AD8506
Quad	AD8504	ADA4505-4	AD8508

Rev. A

Information furnished by Analog Devices is believed to be accurate and reliable. However, no responsibility is assumed by Analog Devices for its use, nor for any infringements of patents or other rights of third parties that may result from its use. Specifications subject to change without notice. No license is granted by implication or otherwise under any patent or patent rights of Analog Devices. Trademarks and registered trademarks are the property of their respective owners.

TABLE OF CONTENTS

Features	1	Absolute Maximum Ratings	6
Applications.....	1	Thermal Resistance	6
Pin Configurations	1	ESD Caution.....	6
General Description	1	Typical Performance Characteristics	7
Revision History	2	Outline Dimensions	14
Specifications.....	3	Ordering Guide	14
Electrical Characteristics	3		

REVISION HISTORY

2/09—Rev. 0 to Rev. A

Changes to General Description Section	1
Added Table 1; Renumbered Sequentially	1
Changes to Typical Performance Characteristics Section.....	7
Updated Outline Dimensions	14

1/07—Revision 0: Initial Version

SPECIFICATIONS

ELECTRICAL CHARACTERISTICS

@ $V_S = 5\text{ V}$, $V_{CM} = V_S/2$, $T_A = 25^\circ\text{C}$, unless otherwise noted.

Table 2.

Parameter	Symbol	Conditions	Min	Typ	Max	Unit
INPUT CHARACTERISTICS						
Offset Voltage	V_{OS}	$0\text{ V} < V_{CM} < 5\text{ V}$ $-40^\circ\text{C} < T_A < +85^\circ\text{C}$ $-40^\circ\text{C} < T_A < +125^\circ\text{C}$		0.5	3 5 5.5	mV mV mV
Offset Voltage Drift	$\Delta V_{OS}/\Delta T$	$-40^\circ\text{C} < T_A < +85^\circ\text{C}$ $-40^\circ\text{C} < T_A < +125^\circ\text{C}$		7 5		$\mu\text{V}/^\circ\text{C}$ $\mu\text{V}/^\circ\text{C}$
Input Bias Current	I_B	$0\text{ V} < V_{CM} < 5\text{ V}$ $-40^\circ\text{C} < T_A < +85^\circ\text{C}$ $-40^\circ\text{C} < T_A < +125^\circ\text{C}$		1	10 100 600	pA pA pA
Input Offset Current	I_{OS}	$0\text{ V} < V_{CM} < 5\text{ V}$ $-40^\circ\text{C} < T_A < +85^\circ\text{C}$ $-40^\circ\text{C} < T_A < +125^\circ\text{C}$		0.5	5 50 100	pA pA pA
Input Voltage Range	IVR		0		5.0	V
Common-Mode Rejection Ratio	CMRR	$0\text{ V} < V_{CM} < 5\text{ V}$ $-40^\circ\text{C} < T_A < +85^\circ\text{C}$ -40°C to $+125^\circ\text{C}$	67 65 65	76		dB dB dB
Large Signal Voltage Gain	A_{VO}	$0.1\text{ V} < V_{OUT} < 4.9\text{ V}$; $R_{LOAD} = 1\text{ M}\Omega$ $0.1\text{ V} < V_{OUT} < 4.9\text{ V}$; $-40^\circ\text{C} < T_A < +85^\circ\text{C}$ $0.1\text{ V} < V_{OUT} < 4.9\text{ V}$; $-40^\circ\text{C} < T_A < +125^\circ\text{C}$	98 93 75	120		dB dB dB
Input Capacitance	C_{DIFF} C_{CM}			2 4.5		pF pF
OUTPUT CHARACTERISTICS						
Output Voltage High	V_{OH}	$R_{LOAD} = 100\text{ k}\Omega$ to GND $-40^\circ\text{C} < T_A < +85^\circ\text{C}$ -40°C to $+125^\circ\text{C}$ $R_{LOAD} = 10\text{ k}\Omega$ to GND $-40^\circ\text{C} < T_A < +85^\circ\text{C}$ -40°C to $+125^\circ\text{C}$	4.970 4.960 4.950 4.900 4.810 4.650	4.990 4.930		V V V V V V
Output Voltage Low	V_{OL}	$R_{LOAD} = 100\text{ k}\Omega$ to V_S $-40^\circ\text{C} < T_A < +85^\circ\text{C}$ -40°C to $+125^\circ\text{C}$ $R_{LOAD} = 10\text{ k}\Omega$ to V_S $-40^\circ\text{C} < T_A < +85^\circ\text{C}$ -40°C to $+125^\circ\text{C}$		1.6 15 20 37 40	5 7 7 20 37 40	mV mV mV mV mV mV
Short-Circuit Current	I_{SC}	$V_{OUT} = \text{GND}$		± 5		mA
POWER SUPPLY						
Power Supply Rejection Ratio	PSRR	$1.8\text{ V} < V_S < 5\text{ V}$ $-40^\circ\text{C} < T_A < +85^\circ\text{C}$ $-40^\circ\text{C} < T_A < +125^\circ\text{C}$	85 66 66	105		dB dB dB
Supply Current/Amplifier	I_{SY}	$V_O = V_S/2$ $-40^\circ\text{C} < T_A < +85^\circ\text{C}$ $-40^\circ\text{C} < T_A < +125^\circ\text{C}$		0.75	1 1.5 2	μA μA μA
DYNAMIC PERFORMANCE						
Slew Rate	SR	$R_{LOAD} = 1\text{ M}\Omega$		0.004		V/ μs
Gain Bandwidth Product	GBP			7		kHz
Phase Margin	ϕ_O			60		Degrees

AD8502/AD8504

Parameter	Symbol	Conditions	Min	Typ	Max	Unit
NOISE PERFORMANCE						
Peak-to-Peak Noise		0.1 Hz to 10 Hz		6		$\mu\text{V p-p}$
Voltage Noise Density	e_n	$f = 1 \text{ kHz}$		190		$\text{nV}/\sqrt{\text{Hz}}$
Current Noise Density	i_n	$f = 1 \text{ kHz}$		0.1		$\text{pA}/\sqrt{\text{Hz}}$

@ $V_S = 1.8 \text{ V}$, $V_{CM} = V_S/2$, $T_A = 25^\circ\text{C}$, unless otherwise noted.

Table 3.

Parameter	Symbol	Conditions	Min	Typ	Max	Unit
INPUT CHARACTERISTICS						
Offset Voltage	V_{OS}	$0 \text{ V} < V_{CM} < 1.8 \text{ V}$ $-40^\circ\text{C} < T_A < +85^\circ\text{C}$ $-40^\circ\text{C} < T_A < +125^\circ\text{C}$		0.5	3	mV
Offset Voltage Drift	$\Delta V_{OS}/\Delta T$	$-40^\circ\text{C} < T_A < +85^\circ\text{C}$ $-40^\circ\text{C} < T_A < +125^\circ\text{C}$		7	5	$\mu\text{V}/^\circ\text{C}$
Input Bias Current	I_B	$0 \text{ V} < V_{CM} < 1.8 \text{ V}$ $-40^\circ\text{C} < T_A < +85^\circ\text{C}$ $-40^\circ\text{C} < T_A < +125^\circ\text{C}$		1	10	pA
Input Offset Current	I_{OS}	$0 \text{ V} < V_{CM} < 1.8 \text{ V}$ $-40^\circ\text{C} < T_A < +85^\circ\text{C}$ $-40^\circ\text{C} < T_A < +125^\circ\text{C}$		0.5	5	pA
Input Voltage Range	IVR		0		1.8	V
Common-Mode Rejection Ratio	CMRR	$0 \text{ V} < V_{CM} < 1.8 \text{ V}$ $-40^\circ\text{C} < T_A < +85^\circ\text{C}$ $-40^\circ\text{C} < T_A < +125^\circ\text{C}$	59	75		dB
Large Signal Voltage Gain	A_{VO}	$0.1 \text{ V} < V_{OUT} < 1.7 \text{ V}$; $R_{LOAD} = 1 \text{ M}\Omega$ $0.1 \text{ V} < V_{OUT} < 1.7 \text{ V}$; $-40^\circ\text{C} < T_A < +85^\circ\text{C}$ $0.1 \text{ V} < V_{OUT} < 1.7 \text{ V}$; $-40^\circ\text{C} < T_A < +125^\circ\text{C}$	88	110		dB
Input Capacitance	C_{DIFF} C_{CM}			2		pF
OUTPUT CHARACTERISTICS						
Output Voltage High	V_{OH}	$R_{LOAD} = 100 \text{ k}\Omega$ to GND $-40^\circ\text{C} < T_A < +85^\circ\text{C}$ -40°C to $+125^\circ\text{C}$ $R_{LOAD} = 10 \text{ k}\Omega$ to GND $-40^\circ\text{C} < T_A < +85^\circ\text{C}$ -40°C to $+125^\circ\text{C}$	1.79 1.78 1.77 1.75 1.70 1.65	1.795 1.764		V
Output Voltage Low	V_{OL}	$R_{LOAD} = 100 \text{ k}\Omega$ to V_S $-40^\circ\text{C} < T_A < +85^\circ\text{C}$ -40°C to $+125^\circ\text{C}$ $R_{LOAD} = 10 \text{ k}\Omega$ to V_S $-40^\circ\text{C} < T_A < +85^\circ\text{C}$ -40°C to $+125^\circ\text{C}$		1.0 10	5 20	mV
Short-Circuit Current	I_{SC}			± 5	29	mV
POWER SUPPLY						
Power Supply Rejection Ratio	PSRR	$1.8 \text{ V} < V_S < 5 \text{ V}$ $-40^\circ\text{C} < T_A < +85^\circ\text{C}$ $-40^\circ\text{C} < T_A < +125^\circ\text{C}$	85 66 66	105		dB
Supply Current/Amplifier	I_{SY}	$V_O = V_S/2$ $-40^\circ\text{C} < T_A < +85^\circ\text{C}$ $-40^\circ\text{C} < T_A < +125^\circ\text{C}$		0.65	1 1.5 2	μA

Parameter	Symbol	Conditions	Min	Typ	Max	Unit
DYNAMIC PERFORMANCE						
Slew Rate	SR	$R_{LOAD} = 1\text{ M}\Omega$		0.004		V/ μ s
Gain Bandwidth Product	GBP			7		kHz
Phase Margin	ϕ_0			60		Degrees
NOISE PERFORMANCE						
Peak-to-Peak Noise		0.1 Hz to 10 Hz		6		μ V p-p
Voltage Noise Density	e_n	f = 1 kHz		190		nV/ $\sqrt{\text{Hz}}$
Current Noise Density	i_n	f = 1 kHz		0.1		pA/ $\sqrt{\text{Hz}}$

ABSOLUTE MAXIMUM RATINGS

$T_A = 25^\circ\text{C}$, unless otherwise noted.

Table 4.

Parameter	Rating
Supply Voltage	6 V
Input Voltage	$V_{SS} - 0.3\text{ V}$ to $V_{DD} + 0.3\text{ V}$
Differential Input Voltage	$\pm 6\text{ V}$
Output Short-Circuit Duration to GND	Indefinite
Storage Temperature Range	-65°C to $+150^\circ\text{C}$
Operating Temperature Range	-40°C to $+125^\circ\text{C}$
Junction Temperature Range	-65°C to $+150^\circ\text{C}$
Lead Temperature (Soldering, 60 sec)	300°C

Stresses above those listed under Absolute Maximum Ratings may cause permanent damage to the device. This is a stress rating only; functional operation of the device at these or any other conditions above those indicated in the operational section of this specification is not implied. Exposure to absolute maximum rating conditions for extended periods may affect device reliability.

Absolute maximum ratings apply at 25°C , unless otherwise noted.

THERMAL RESISTANCE

θ_{JA} is specified for the worst-case conditions, that is, a device soldered in a circuit board for surface-mount packages.

Table 5. Thermal Characteristics

Package Type	θ_{JA}	θ_{JC}	Unit
8-Lead SOT-23 (RJ-8)	376	126	$^\circ\text{C}/\text{W}$
14-Lead TSSOP (RU-14)	180	35	$^\circ\text{C}/\text{W}$

ESD CAUTION



ESD (electrostatic discharge) sensitive device. Charged devices and circuit boards can discharge without detection. Although this product features patented or proprietary protection circuitry, damage may occur on devices subjected to high energy ESD. Therefore, proper ESD precautions should be taken to avoid performance degradation or loss of functionality.

TYPICAL PERFORMANCE CHARACTERISTICS

$T_A = 25^\circ\text{C}$, unless otherwise noted.

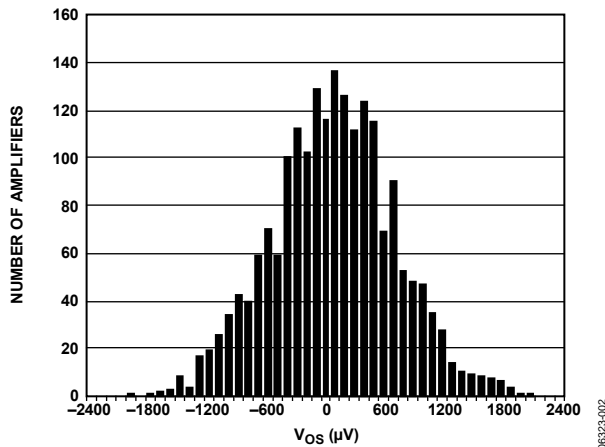

Figure 3. Input Offset Voltage Distribution ($0\text{ V} < V_{CM} < 5.0\text{ V}$), $V_S = 5\text{ V}$

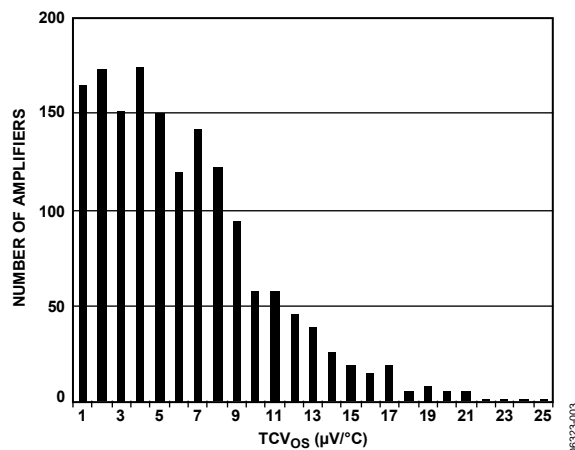

Figure 4. Input Offset Voltage Temperature Drift Distribution ($-40^\circ\text{C} < T_A < +85^\circ\text{C}$), $V_S = 5\text{ V}$

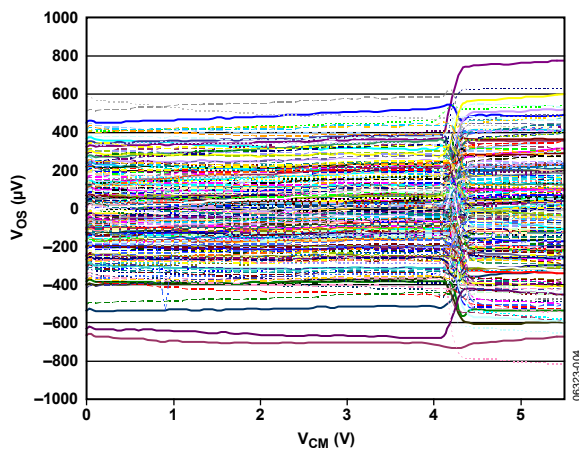

Figure 5. Input Offset Voltage vs. Common-Mode Voltage, $V_S = 5\text{ V}$

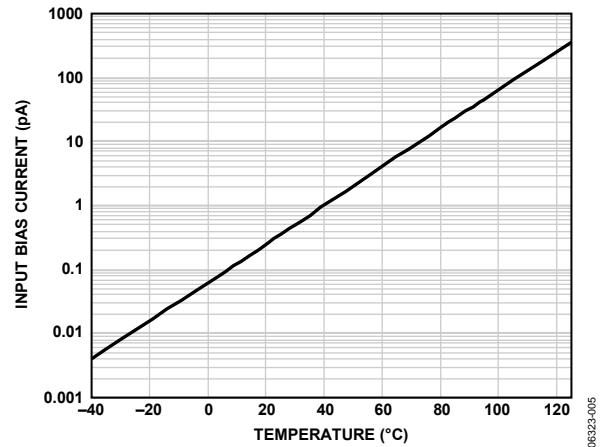

Figure 6. Input Bias Current vs. Temperature ($V_S = 1.8\text{ V}$ and 5.0 V)

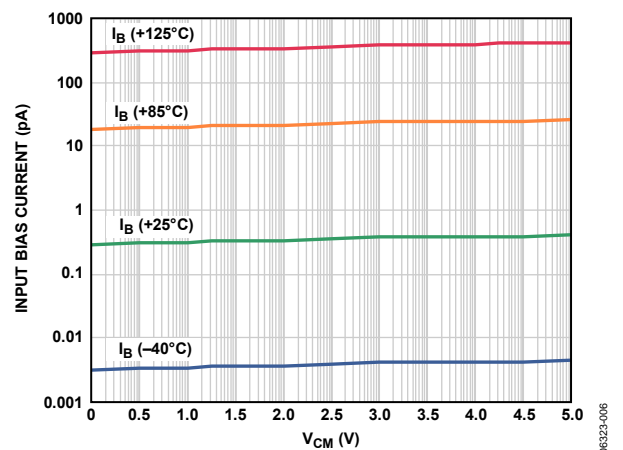

Figure 7. Input Bias Current vs. Common-Mode Voltage, $V_S = 5\text{ V}$

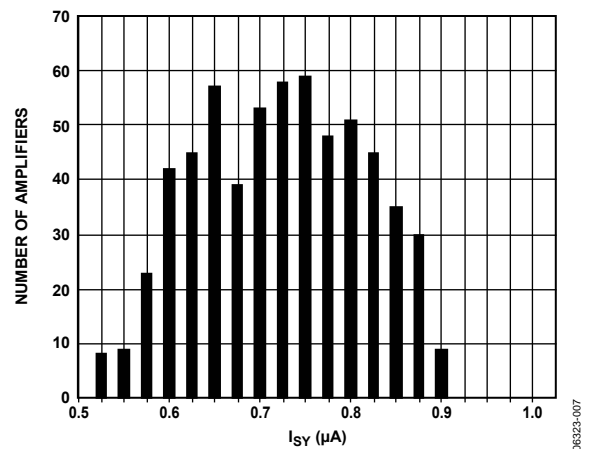

Figure 8. Supply Current Distribution, $V_S = 5\text{ V}$

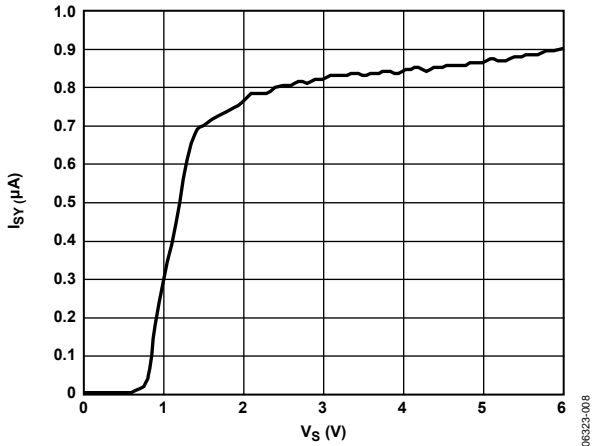

Figure 9. Supply Current vs. Supply Voltage

06323-008

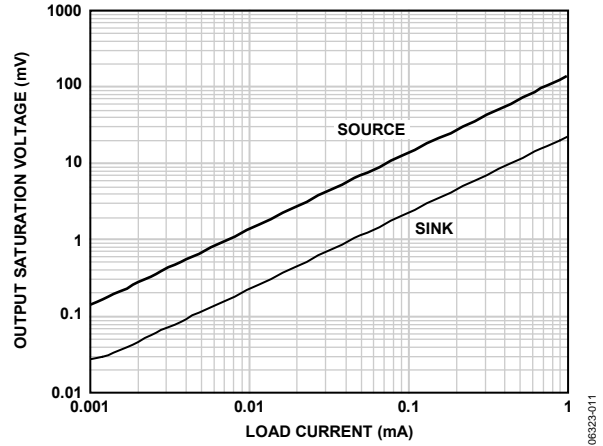

Figure 12. Output Saturation Voltage vs. Load Current, $V_S = 5\text{ V}$

06323-011

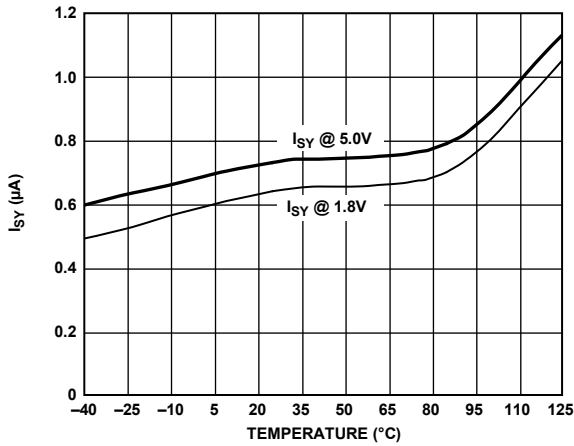

Figure 10. Supply Current vs. Temperature

06323-009

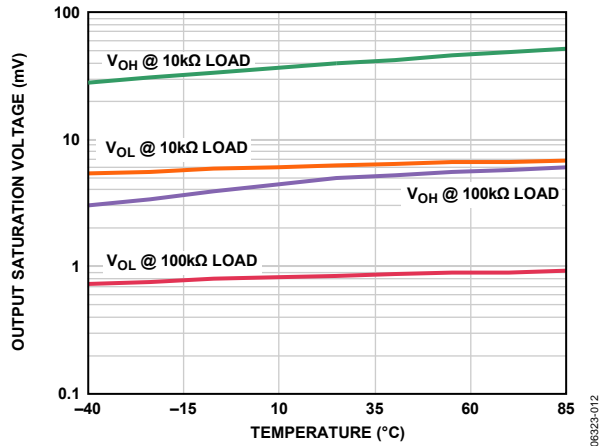

Figure 13. Output Saturation Voltage vs. Temperature, $V_S = 5\text{ V}$

06323-012

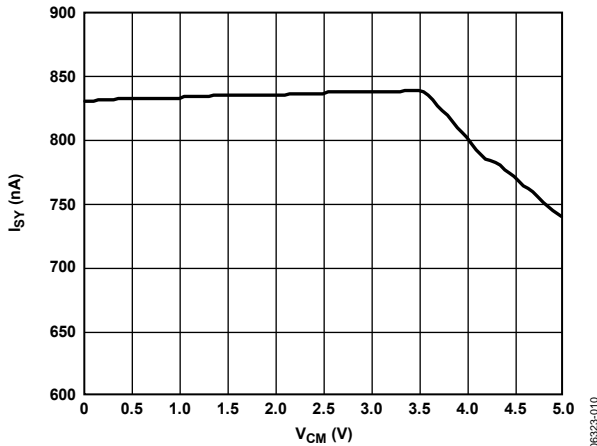

Figure 11. Supply Current vs. Input Common-Mode Voltage, $V_S = 5\text{ V}$

06323-010

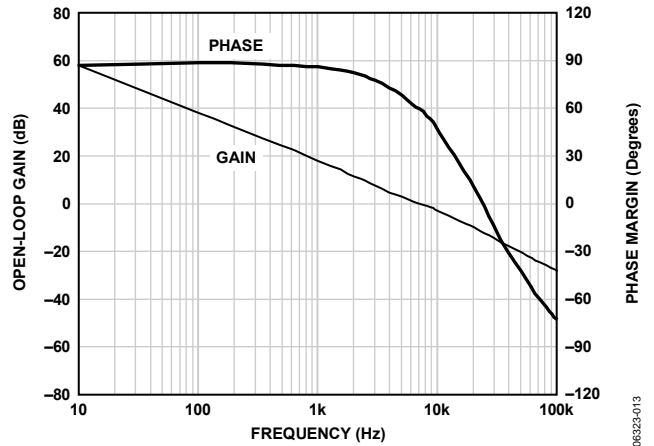

Figure 14. Open-Loop Gain and Phase vs. Frequency, $V_S = 5\text{ V}$

06323-013

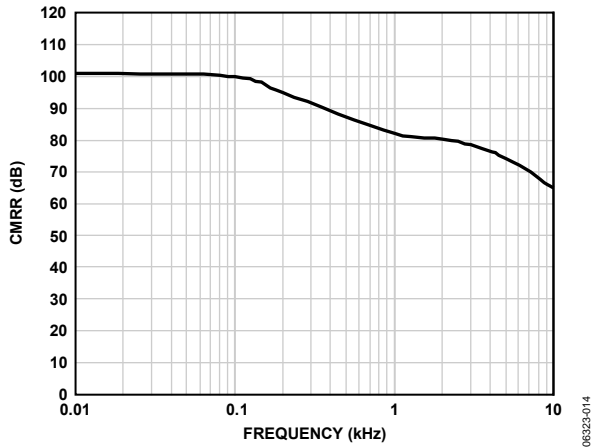

Figure 15. CMRR vs. Frequency, $V_S = 5\text{ V}$

06323-014

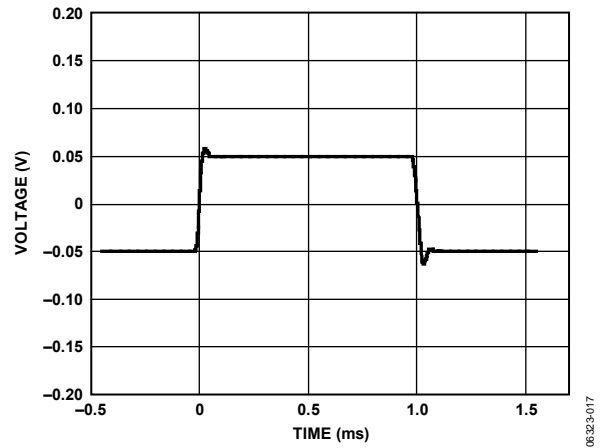

Figure 18. Small Signal Transient Response (No Load), $V_S = 5\text{ V}$

06323-017

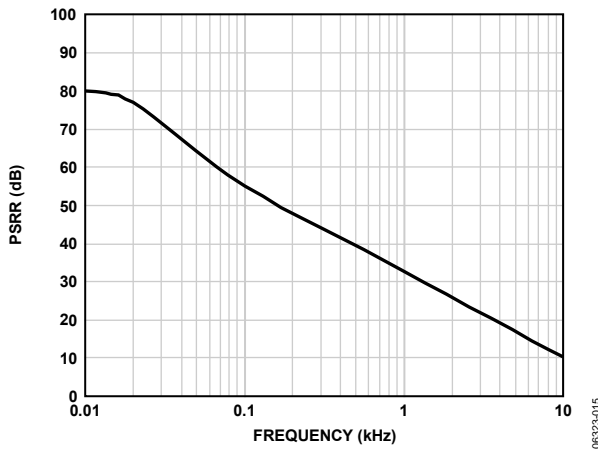

Figure 16. PSRR vs. Frequency, $V_S = 5\text{ V}$

06323-015

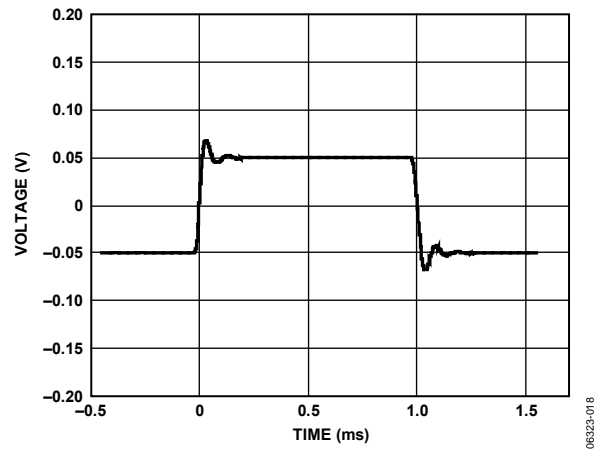

Figure 19. Small Signal Transient Response (100 pF Load Capacitance, $V_S = 5\text{ V}$)

06323-018

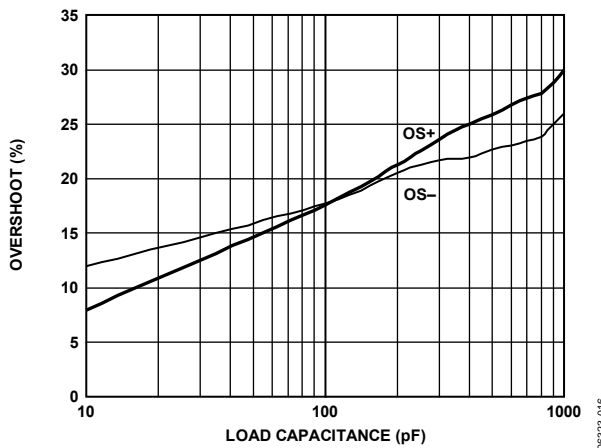

Figure 17. Small Signal Overshoot vs. Load Capacitance, $V_S = 5\text{ V}$

06323-016

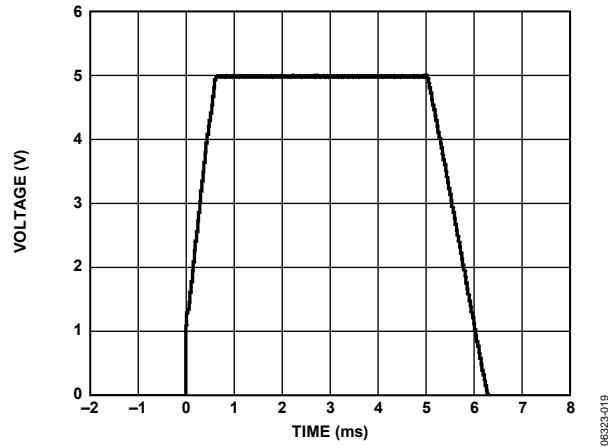

Figure 20. Large Signal Transient Response No Load, $V_S = 5\text{ V}$

06323-019

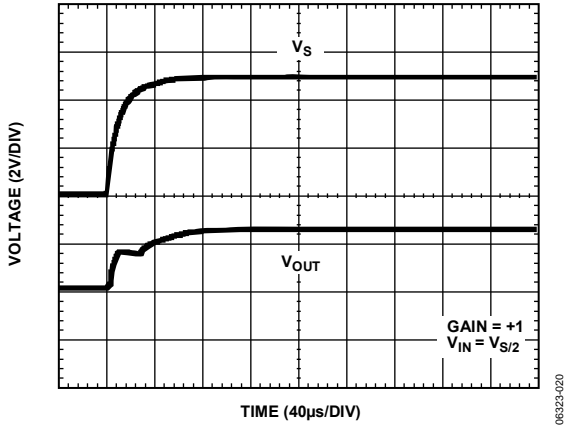

Figure 21. Turn-On Transient Response, $V_S = 5\text{ V}$

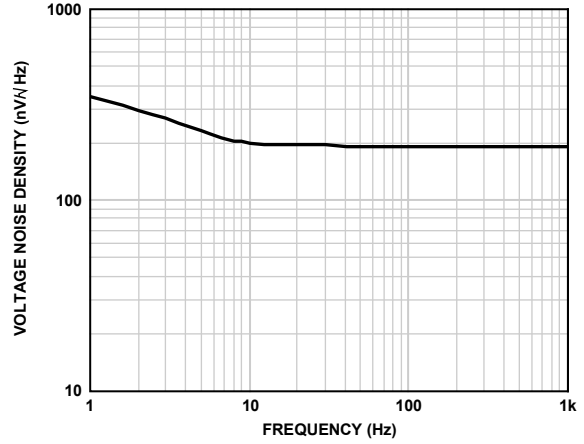

Figure 24. Input Voltage Noise ($V_S = 5\text{ V}$ and 1.8 V)

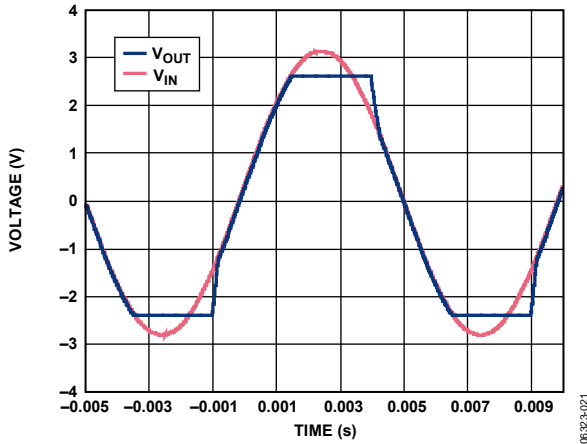

Figure 22. No Phase Reversal, $V_S = 5\text{ V}$

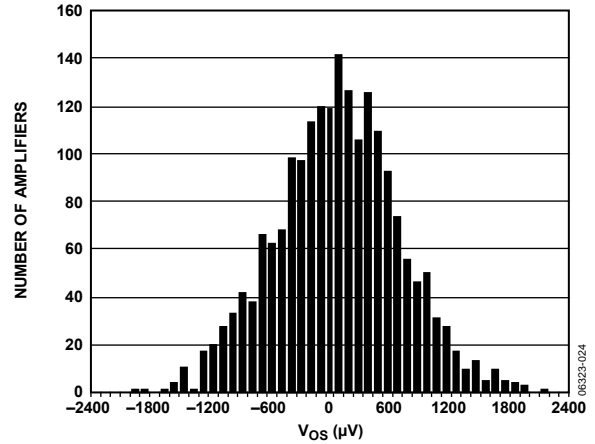

Figure 25. Input Offset Voltage Distribution ($0\text{ V} < V_{CM} < 1.8\text{ V}$), $V_S = 1.8\text{ V}$

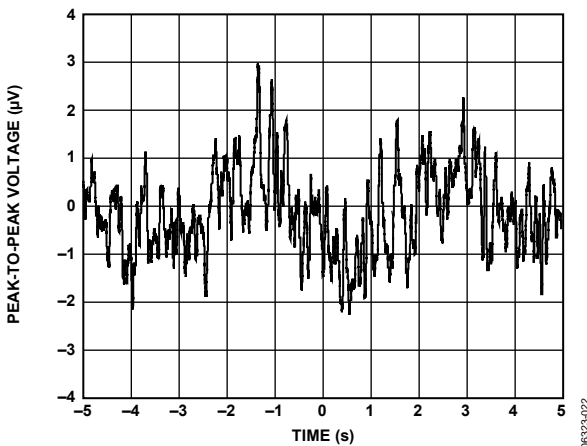

Figure 23. 0.1 Hz to 10 Hz Input Voltage Noise ($V_S = 5\text{ V}$ and 1.8 V)

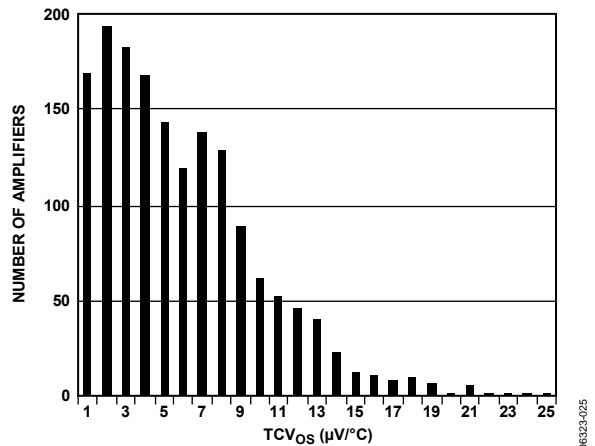

Figure 26. Input Offset Voltage Temperature Drift Distribution ($-40^\circ\text{C} < T_A < +85^\circ\text{C}$), $V_S = 1.8\text{ V}$

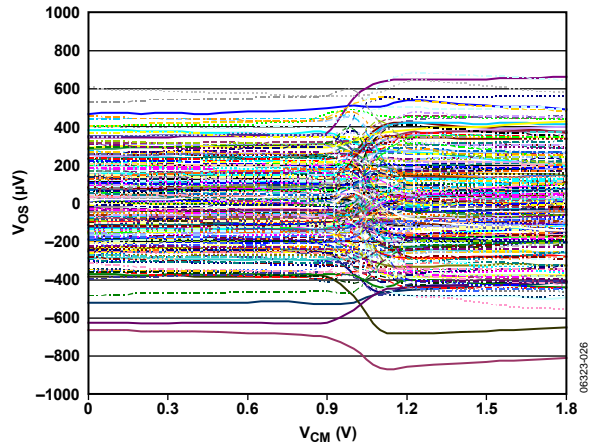

Figure 27. Input Offset Voltage vs. Input Common-Mode Voltage, $V_S = 1.8\text{ V}$

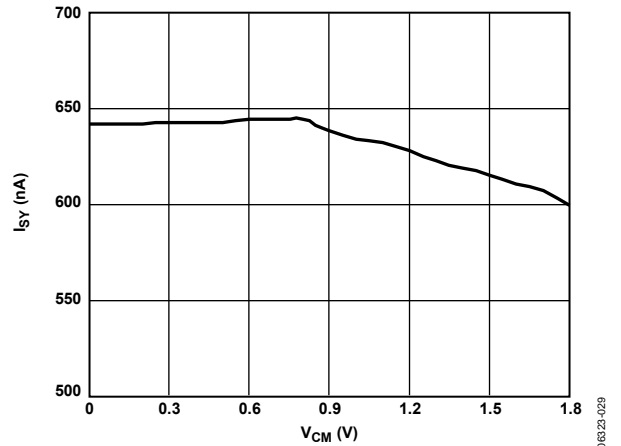

Figure 30. Supply Current vs. Input Common-Mode Voltage, $V_S = 1.8\text{ V}$

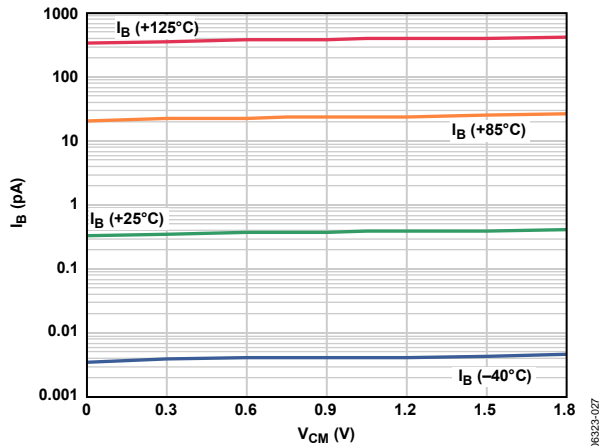

Figure 28. Input Bias Current vs. Input Common-Mode Voltage, $V_S = 1.8\text{ V}$

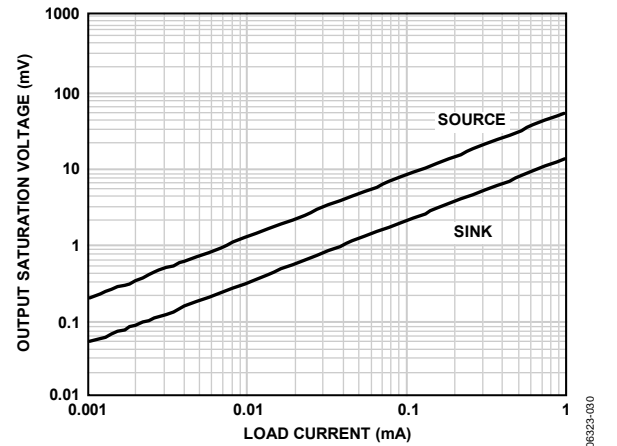

Figure 31. Output Saturation Voltage vs. Load Current $V_S = 1.8\text{ V}$

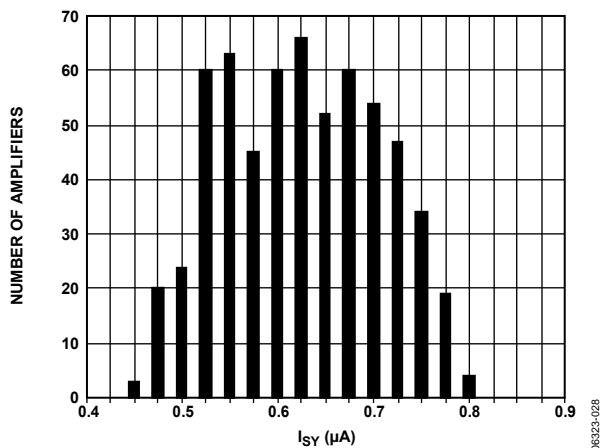

Figure 29. Supply Current Distribution, $V_S = 1.8\text{ V}$

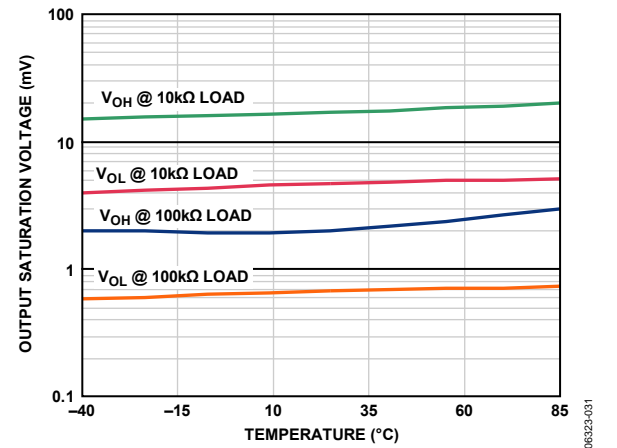

Figure 32. Output Saturation Voltage vs. Temperature, $V_S = 1.8\text{ V}$

AD8502/AD8504

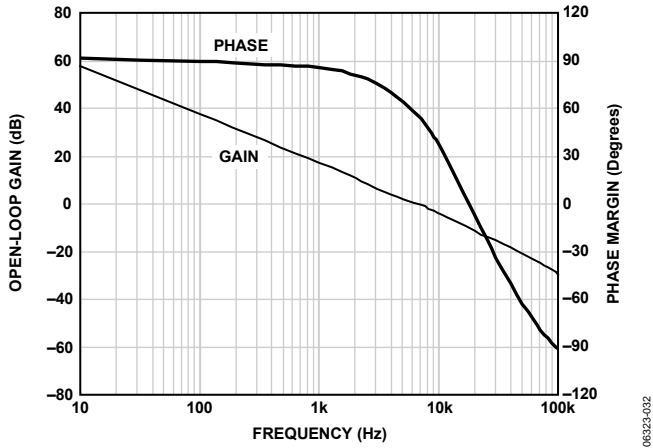

Figure 33. Open-Loop Gain and Phase vs. Frequency, $V_S = 1.8\text{ V}$

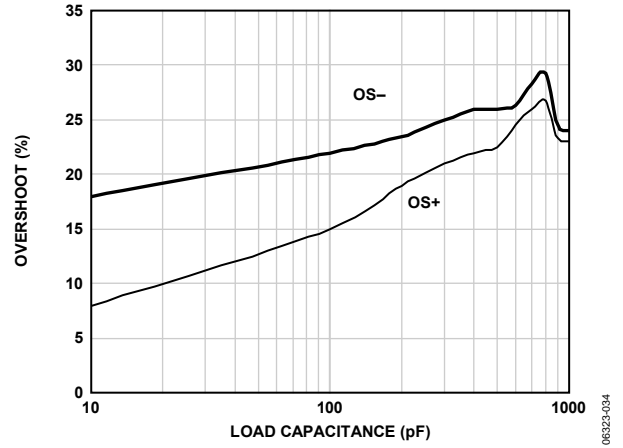

Figure 35. Small Signal Overshoot vs. Load Capacitance, $V_S = 1.8\text{ V}$

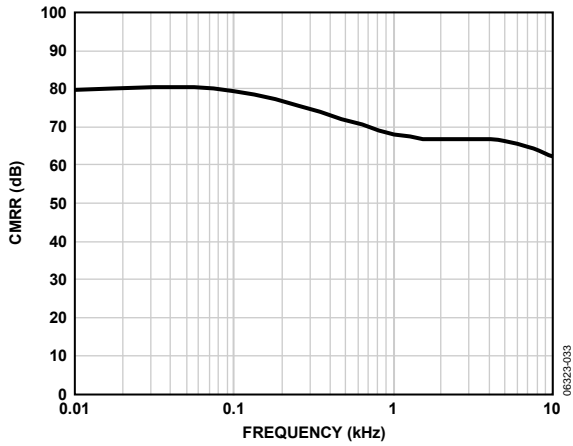

Figure 34. CMRR vs. Frequency, $V_S = 1.8\text{ V}$

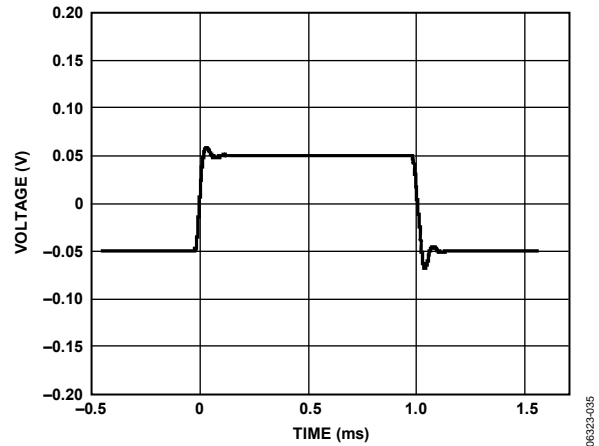

Figure 36. Small Signal Transient Response (No Load), $V_S = 1.8\text{ V}$

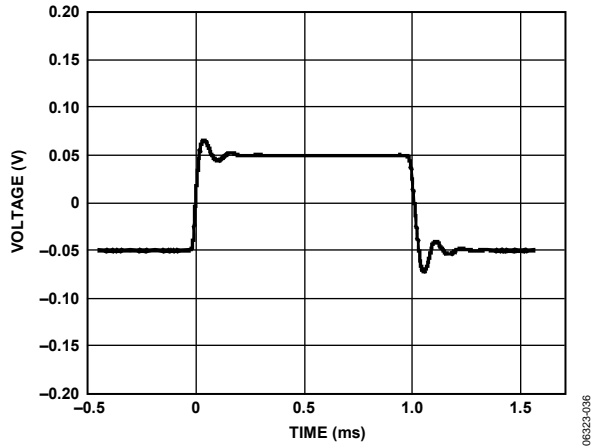

Figure 37. Small Signal Transient Response (100 pF Load Capacitance), $V_S = 1.8\text{ V}$

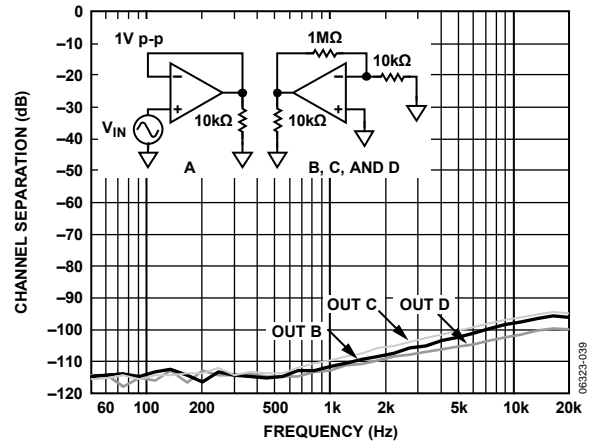

Figure 39. Channel Separation

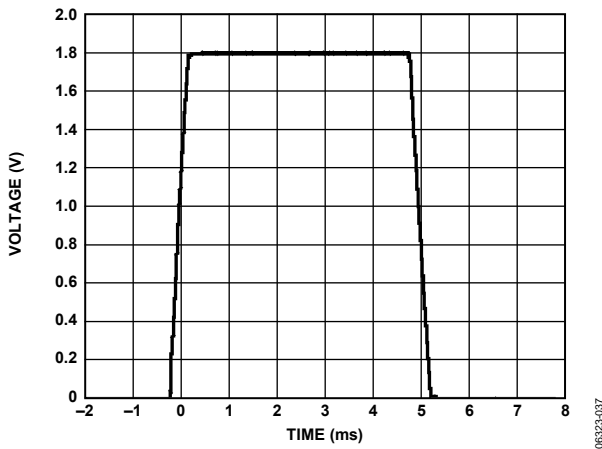
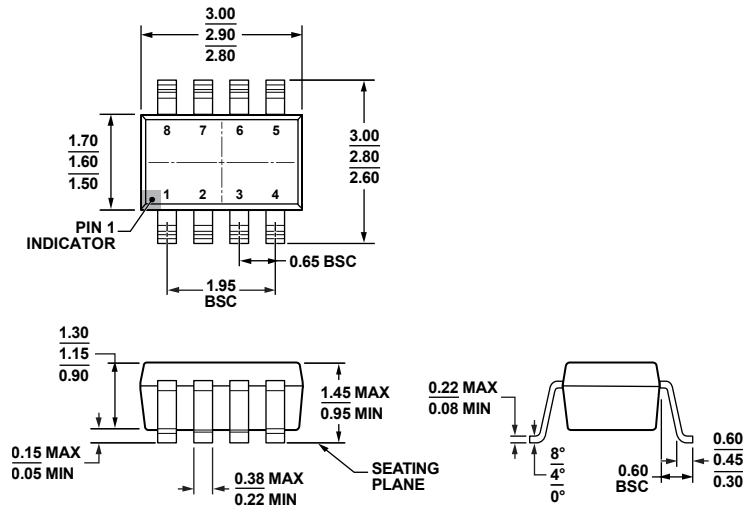

Figure 38. Large Signal Transient Response (No Load), $V_S = 1.8\text{ V}$

AD8502/AD8504

OUTLINE DIMENSIONS



COMPLIANT TO JEDEC STANDARDS MO-178-BA

Figure 40. 8-Lead Small Outline Transistor Package [SOT-23] (RJ-8)

Dimensions shown in millimeters

121608-A

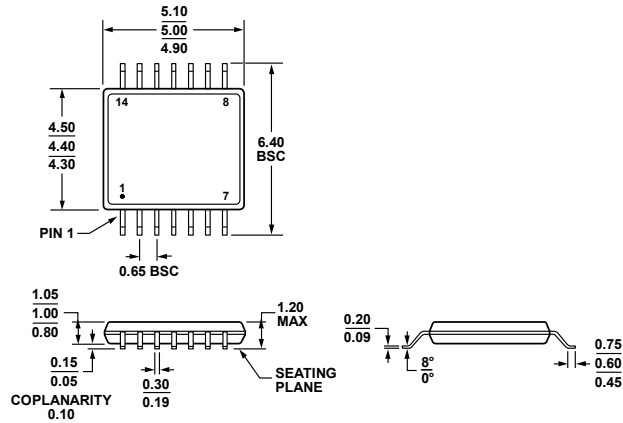

COMPLIANT TO JEDEC STANDARDS MO-153-AB-1

Figure 41. 14-Lead Thin Shrink Small Outline Package [TSSOP] (RU-14)

Dimensions shown in millimeters

061608-A

ORDERING GUIDE

Model	Temperature Range	Package Description	Package Option	Branding
AD8502ARJZ-R2 ¹	-40°C to +125°C	8-Lead SOT-23	RJ-8	A1D
AD8502ARJZ-REEL ¹	-40°C to +125°C	8-Lead SOT-23	RJ-8	A1D
AD8502ARJZ-REEL7 ¹	-40°C to +125°C	8-Lead SOT-23	RJ-8	A1D
AD8504ARUZ ¹	-40°C to +125°C	14-Lead TSSOP	RU-14	
AD8504ARUZ-REEL ¹	-40°C to +125°C	14-Lead TSSOP	RU-14	

¹ Z = RoHS Compliant Part.

NOTES

NOTES

Mouser Electronics

Authorized Distributor

Click to View Pricing, Inventory, Delivery & Lifecycle Information:

[Analog Devices Inc.:](#)

[AD8502ARJZ-R2](#)