

FEATURES

- Low offset voltage: 5 μV maximum
- Extremely low offset voltage drift: 22 $\text{nV}/^\circ\text{C}$ maximum
- Low voltage noise density: 5.8 $\text{nV}/\sqrt{\text{Hz}}$ typical
117 nV p-p typical from 0.1 Hz to 10 Hz
- Low input bias current: 50 pA typical
- Unity-gain crossover: 3 MHz typical
- Single-supply operation: input voltage range includes ground and rail-to-rail output
- Wide range of operating voltages
Single-supply operation: 4.5 V to 55 V
Dual-supply operation: ± 2.25 V to ± 27.5 V
- Integrated EMI filters
- Unity-gain stable

APPLICATIONS

- Inductance, capacitance, and resistance (LCR) meter/
megohmmeter front-end amplifiers
- Load cell and bridge transducers
- Magnetic force balance scales
- High precision shunt current sensing
- Thermocouple/resistance temperature detector (RTD) sensors
- Programmable logic controller (PLC) input and output
amplifiers

GENERAL DESCRIPTION

The ADA4522-1/ADA4522-2/ADA4522-4 are single/dual/quad channel, zero drift op amps with low noise and power, ground sensing inputs, and rail-to-rail output, optimized for total accuracy over time, temperature, and voltage conditions. The wide operating voltage and temperature ranges, as well as the high open-loop gain and very low dc and ac errors make the devices well suited for amplifying very small input signals and for accurately reproducing larger signals in a wide variety of applications.

The ADA4522-1/ADA4522-2/ADA4522-4 performance is specified at 5.0 V, 30 V, and 55 V power supply voltages. These devices operate over the range of 4.5 V to 55 V, and are excellent for applications using single-ended supplies of 5 V, 10 V, 12 V, and 30 V, or for applications using higher single supplies and dual supplies of ± 2.5 V, ± 5 V, and ± 15 V. The ADA4522-1/ADA4522-2/ADA4522-4 use on-chip filtering to achieve high immunity to electromagnetic interference (EMI).

The ADA4522-1/ADA4522-2/ADA4522-4 are fully specified over the extended industrial temperature range of -40°C to $+125^\circ\text{C}$ and are available in 8-lead MSOP, 8-lead SOIC, 14-lead SOIC, and 14-lead TSSOP packages.

Rev. F

Document Feedback

Information furnished by Analog Devices is believed to be accurate and reliable. However, no responsibility is assumed by Analog Devices for its use, nor for any infringements of patents or other rights of third parties that may result from its use. Specifications subject to change without notice. No license is granted by implication or otherwise under any patent or patent rights of Analog Devices. Trademarks and registered trademarks are the property of their respective owners.

PIN CONNECTION DIAGRAM

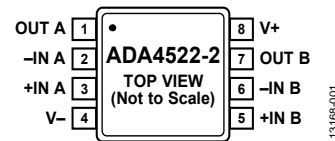

Figure 1. 8-Lead MSOP (RM Suffix) and 8-Lead SOIC (R Suffix) Pin Configuration

For the ADA4522-1 and ADA4522-4 pin connections and for more information about the pin connections for these products, see the Pin Configurations and Function Descriptions section.

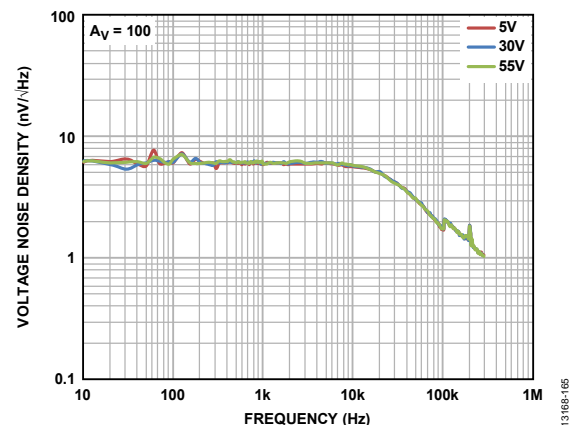

Figure 2. Voltage Noise Density vs. Frequency, $V_{\text{SY}} = \pm 15$ V

Table 1. Zero Drift Op Amps ($<0.1 \mu\text{V}/^\circ\text{C}$)

Supply Voltage	5 V	16 V	30 V	55 V
Single	ADA4528-1 AD8628 AD8538 ADA4051-1	AD8638	ADA4638-1	ADA4522-1
Dual	ADA4528-2 AD8629 AD8539 ADA4051-2	AD8639		ADA4522-2
Quad	AD8630			ADA4522-4

TABLE OF CONTENTS

Features 1

Applications 1

General Description 1

Pin Connection Diagram 1

Revision History 2

Specifications 3

 Electrical Characteristics—5.0 V Operation 3

 Electrical Characteristics—30 V Operation 4

 Electrical Characteristics—55 V Operation 5

Absolute Maximum Ratings 7

 Thermal Resistance 7

 Power Sequencing 7

 ESD Caution 7

Pin Configurations and Function Descriptions 8

Typical Performance Characteristics 10

Theory of Operation 21

 On-Chip Input EMI Filter and Clamp Circuit 22

 Thermal Shutdown 22

REVISION HISTORY

9/2017—Rev. E to Rev. F

Added Power Sequencing Section 7

Added Use of Large Source Resistance Section 30

Added Figure 89 and Table 11; Renumbered Sequentially 30

10/2016—Rev. D to Rev. E

Changes to Figure 73 23

4/2016—Rev. C to Rev. D

Changed ADA4522-4 Pin 4 to V+ Throughout

Changed ADA4522-4 Pin 11 to V- Throughout

Changes to Figure 5 and Table 9 9

2/2016—Rev. B to Rev. C

Added ADA4522-1 Universal

Changes to Common-Mode Rejection Ratio Parameter and Supply Current per Amplifier Parameter, Table 2 3

Changes to Offset Voltage Drift Parameter, and Supply Current per Amplifier Parameter, Table 3 4

Changes to Offset Voltage Drift Parameter, Input Offset Current Parameter, and Supply Current per Amplifier Parameter, Table 4 5

Added Figure 3 and Table 7; Renumbered Sequentially 8

Moved Theory of Operation Section 21

Changes to Figure 71 21

Changes to Figure 72 22

Changes to Ordering Guide 32

Input Protection 22

Single-Supply and Rail-to-Rail Output 23

Large Signal Transient Response 23

Noise Considerations 24

EMI Rejection Ratio 25

Capacitive Load Stability 25

Applications Information 27

 Single-Supply Instrumentation Amplifier 27

 Load Cell/Strain Gage Sensor Signal Conditioning Using the ADA4522-2 27

 Precision Low-Side Current Shunt Sensor 28

 Printed Circuit Board Layout 28

 Comparator Operation 29

 Use of Large Source Resistance 30

Outline Dimensions 31

 Ordering Guide 32

1/2016—Rev. A to Rev. B

Updated Outline Dimensions 29

10/2015—Rev. 0 to Rev. A

Added ADA4522-4 Universal

Changes to General Description Section 1

Change to Common-Mode Rejection Ratio Parameter, Table 2 3

Change to Offset Voltage Drift Parameter, Table 3 4

Change to Offset Voltage Drift Parameter and Input Offset Current Parameter, Table 4 5

Changes to Table 6 7

Added Figure 4 and Table 8; Renumbered Sequentially 8

Changes to Figure 34 13

Changes to Figure 67 19

Changes to Applications Information Section 20

Changes to Thermal Shutdown Section 21

Changes to Single-Supply Instrumentation Amplifier Section 25

Changes to Precision Low-Side Current Shunt Sensor Section 27

Changes to Printed Circuit Board Layout Section 28

Added Figure 89 and Figure 90; Outline Dimensions 30

Changes to Ordering Guide 30

5/2015—Revision 0: Initial Version

SPECIFICATIONS

ELECTRICAL CHARACTERISTICS—5.0 V OPERATION

$V_{SY} = 5.0 \text{ V}$, $V_{CM} = V_{SY}/2$, $T_A = 25^\circ\text{C}$, unless otherwise specified.

Table 2.

Parameter	Symbol	Test Conditions/Comments	Min	Typ	Max	Unit
INPUT CHARACTERISTICS						
Offset Voltage	V_{OS}	$V_{CM} = V_{SY}/2$ $-40^\circ\text{C} \leq T_A \leq +125^\circ\text{C}$		0.7	5	μV
Offset Voltage Drift	TCV_{OS}			2.5	15	$\text{nV}/^\circ\text{C}$
Input Bias Current	I_B	$-40^\circ\text{C} \leq T_A \leq +85^\circ\text{C}$ $-40^\circ\text{C} \leq T_A \leq +125^\circ\text{C}$		50	150	pA
Input Offset Current	I_{OS}	$-40^\circ\text{C} \leq T_A \leq +85^\circ\text{C}$ $-40^\circ\text{C} \leq T_A \leq +125^\circ\text{C}$		80	250	pA
Input Voltage Range	IVR		0		3.5	V
Common-Mode Rejection Ratio	CMRR	ADA4522-1, ADA4522-2, $V_{CM} = 0 \text{ V to } 3.5 \text{ V}$ ADA4522-4, $V_{CM} = 0 \text{ V to } 3.5 \text{ V}$ $-40^\circ\text{C} \leq T_A \leq +125^\circ\text{C}$	135	155		dB
Large Signal Voltage Gain	A_V	$R_L = 10 \text{ k}\Omega$, $V_{OUT} = 0.5 \text{ V to } 4.5 \text{ V}$ $-40^\circ\text{C} \leq T_A \leq +125^\circ\text{C}$	130	145		dB
Input Resistance						
Differential Mode	R_{INDM}			30		$\text{k}\Omega$
Common Mode	R_{INCM}			100		$\text{G}\Omega$
Input Capacitance						
Differential Mode	C_{INDM}			7		pF
Common Mode	C_{INCM}			35		pF
OUTPUT CHARACTERISTICS						
Output Voltage						
High	V_{OH}	$R_L = 10 \text{ k}\Omega$ to $V_{SY}/2$ $-40^\circ\text{C} \leq T_A \leq +125^\circ\text{C}$	4.97	4.98		V
Low	V_{OL}	$R_L = 10 \text{ k}\Omega$ to $V_{SY}/2$ $-40^\circ\text{C} \leq T_A \leq +125^\circ\text{C}$	4.95	20	30	mV
Continuous Output Current	I_{OUT}	Dropout voltage = 1 V		14		mA
Short-Circuit Current Source	I_{SC+}	$T_A = 125^\circ\text{C}$		22		mA
Short-Circuit Current Sink	I_{SC-}	$T_A = 125^\circ\text{C}$		15		mA
Closed-Loop Output Impedance	Z_{OUT}	$T_A = 125^\circ\text{C}$ $f = 1 \text{ MHz}$, $A_V = 1$		19		mA
			4			Ω
POWER SUPPLY						
Power Supply Rejection Ratio	PSRR	$V_{SY} = 4.5 \text{ V to } 5.5 \text{ V}$ $-40^\circ\text{C} \leq T_A \leq +125^\circ\text{C}$	150	160		dB
Supply Current per Amplifier	I_{SY}	ADA4522-2, ADA4522-4, $I_{OUT} = 0 \text{ mA}$ ADA4522-2, ADA4522-4, $-40^\circ\text{C} \leq T_A \leq +125^\circ\text{C}$ ADA4522-1, $I_{OUT} = 0 \text{ mA}$ ADA4522-1, $-40^\circ\text{C} \leq T_A \leq +125^\circ\text{C}$	145	830	900	μA
					950	μA
				840	910	μA
					970	μA
DYNAMIC PERFORMANCE						
Slew Rate	SR+	$R_L = 10 \text{ k}\Omega$, $C_L = 50 \text{ pF}$, $A_V = 1$		1.4		$\text{V}/\mu\text{s}$
	SR-	$R_L = 10 \text{ k}\Omega$, $C_L = 50 \text{ pF}$, $A_V = 1$		1.3		$\text{V}/\mu\text{s}$

Parameter	Symbol	Test Conditions/Comments	Min	Typ	Max	Unit
Gain Bandwidth Product	GBP	$V_{IN} = 10\text{ mV p-p}, R_L = 10\text{ k}\Omega, C_L = 50\text{ pF}, A_v = 100$		2.7		MHz
Unity-Gain Crossover	UGC	$V_{IN} = 10\text{ mV p-p}, R_L = 10\text{ k}\Omega, C_L = 50\text{ pF}, A_v = 1$		3		MHz
-3 dB Closed-Loop Bandwidth	$f_{-3\text{ dB}}$	$V_{IN} = 10\text{ mV p-p}, R_L = 10\text{ k}\Omega, C_L = 50\text{ pF}, A_v = 1$		6.5		MHz
Phase Margin	Φ_M	$V_{IN} = 10\text{ mV p-p}, R_L = 10\text{ k}\Omega, C_L = 50\text{ pF}, A_v = 1$		64		Degrees
Settling Time to 0.1%	t_s	$V_{IN} = 1\text{ V step}, R_L = 10\text{ k}\Omega, C_L = 50\text{ pF}, A_v = 1$		4		μs
Channel Separation	CS	$V_{IN} = 1\text{ V p-p}, f = 10\text{ kHz}, R_L = 10\text{ k}\Omega, C_L = 50\text{ pF}$		98		dB
EMI Rejection Ratio of +IN/+IN x	EMIRR	$V_{IN} = 100\text{ mV peak}, f = 400\text{ MHz}$		72		dB
		$V_{IN} = 100\text{ mV peak}, f = 900\text{ MHz}$		80		dB
		$V_{IN} = 100\text{ mV peak}, f = 1800\text{ MHz}$		83		dB
		$V_{IN} = 100\text{ mV peak}, f = 2400\text{ MHz}$		85		dB
NOISE PERFORMANCE						
Total Harmonic Distortion Plus Noise Bandwidth (BW) = 80 kHz BW = 500 kHz	THD + N	$A_v = 1, f = 1\text{ kHz}, V_{IN} = 0.6\text{ V rms}$		0.001		%
				0.02		%
Peak-to-Peak Voltage Noise	$e_{N\text{ p-p}}$	$A_v = 100, f = 0.1\text{ Hz to }10\text{ Hz}$		117		nV p-p
Voltage Noise Density	e_N	$A_v = 100, f = 1\text{ kHz}$		5.8		nV/ $\sqrt{\text{Hz}}$
Peak-to-Peak Current Noise	$i_{N\text{ p-p}}$	$A_v = 100, f = 0.1\text{ Hz to }10\text{ Hz}$		16		pA p-p
Current Noise Density	i_N	$A_v = 100, f = 1\text{ kHz}$		0.8		pA/ $\sqrt{\text{Hz}}$

ELECTRICAL CHARACTERISTICS—30 V OPERATION

$V_{SY} = 30\text{ V}, V_{CM} = V_{SY}/2\text{ V}, T_A = 25^\circ\text{C}$, unless otherwise specified.

Table 3.

Parameter	Symbol	Test Conditions/Comments	Min	Typ	Max	Unit
INPUT CHARACTERISTICS						
Offset Voltage	V_{OS}	$V_{CM} = V_{SY}/2$ $-40^\circ\text{C} \leq T_A \leq +125^\circ\text{C}$		1	5	μV
Offset Voltage Drift	TCV_{OS}	ADA4522-1, ADA4522-2 ADA4522-4		4	22	nV/ $^\circ\text{C}$
				5.3	25	nV/ $^\circ\text{C}$
Input Bias Current	I_B	$-40^\circ\text{C} \leq T_A \leq +85^\circ\text{C}$ $-40^\circ\text{C} \leq T_A \leq +125^\circ\text{C}$		50	150	pA
					500	pA
Input Offset Current	I_{OS}	$-40^\circ\text{C} \leq T_A \leq +85^\circ\text{C}$ $-40^\circ\text{C} \leq T_A \leq +125^\circ\text{C}$			3	nA
				80	300	pA
					400	pA
Input Voltage Range	IVR		0		28.5	V
Common-Mode Rejection Ratio	CMRR	$V_{CM} = 0\text{ V to }28.5\text{ V}$ $-40^\circ\text{C} \leq T_A \leq +125^\circ\text{C}$		145	160	dB
				140		dB
Large Signal Voltage Gain	A_v	$R_L = 10\text{ k}\Omega, V_{OUT} = 0.5\text{ V to }29.5\text{ V}$ $-40^\circ\text{C} \leq T_A \leq +125^\circ\text{C}$		140	150	dB
				135		dB
Input Resistance	R_{INDM} R_{INCM}			30		k Ω
				400		G Ω
Input Capacitance	C_{INDM} C_{INCM}			7		pF
				35		pF
OUTPUT CHARACTERISTICS						
Output Voltage High	V_{OH}	$R_L = 10\text{ k}\Omega\text{ to }V_{SY}/2$ $-40^\circ\text{C} \leq T_A \leq +125^\circ\text{C}$	29.87	29.89		V
			29.80			V
Low	V_{OL}	$R_L = 10\text{ k}\Omega\text{ to }V_{SY}/2$ $-40^\circ\text{C} \leq T_A \leq +125^\circ\text{C}$		110	130	mV
					200	mV
Continuous Output Current	I_{OUT}	Dropout voltage = 1 V		14		mA

Parameter	Symbol	Test Conditions/Comments	Min	Typ	Max	Unit
Short-Circuit Current Source	I_{SC+}	$T_A = 125^\circ\text{C}$		21		mA
Short-Circuit Current Sink	I_{SC-}	$T_A = 125^\circ\text{C}$		15		mA
Closed-Loop Output Impedance	Z_{OUT}	$T_A = 125^\circ\text{C}$ $f = 1\text{ MHz}, A_V = 1$		33		mA
				22		mA
				4		Ω
POWER SUPPLY						
Power Supply Rejection Ratio	PSRR	$V_{SY} = 4.5\text{ V to }55\text{ V}$ $-40^\circ\text{C} \leq T_A \leq +125^\circ\text{C}$	150	160		dB
Supply Current per Amplifier	I_{SY}	ADA4522-2, ADA4522-4, $I_{OUT} = 0\text{ mA}$ ADA4522-2, ADA4522-4, $-40^\circ\text{C} \leq T_A \leq +125^\circ\text{C}$ ADA4522-1, $I_{OUT} = 0\text{ mA}$ ADA4522-1, $-40^\circ\text{C} \leq T_A \leq +125^\circ\text{C}$	145	830	900	μA
					950	μA
				840	910	μA
					970	μA
DYNAMIC PERFORMANCE						
Slew Rate	SR+	$R_L = 10\text{ k}\Omega, C_L = 50\text{ pF}, A_V = 1$		1.8		V/ μs
	SR-	$R_L = 10\text{ k}\Omega, C_L = 50\text{ pF}, A_V = 1$		0.9		V/ μs
Gain Bandwidth Product	GBP	$V_{IN} = 10\text{ mV p-p}, R_L = 10\text{ k}\Omega, C_L = 50\text{ pF}, A_V = 100$		2.7		MHz
Unity-Gain Crossover	UGC	$V_{IN} = 10\text{ mV p-p}, R_L = 10\text{ k}\Omega, C_L = 50\text{ pF}, A_V = 1$		3		MHz
-3 dB Closed-Loop Bandwidth	$f_{-3\text{ dB}}$	$V_{IN} = 10\text{ mV p-p}, R_L = 10\text{ k}\Omega, C_L = 50\text{ pF}, A_V = 1$		6.5		MHz
Phase Margin	Φ_M	$V_{IN} = 10\text{ mV p-p}, R_L = 10\text{ k}\Omega, C_L = 50\text{ pF}, A_V = 1$		64		Degrees
Settling Time to 0.1%	t_S	$V_{IN} = 10\text{ V step}, R_L = 10\text{ k}\Omega, C_L = 50\text{ pF}, A_V = 1$		12		μs
Settling Time to 0.01%	t_S	$V_{IN} = 10\text{ V step}, R_L = 10\text{ k}\Omega, C_L = 50\text{ pF}, A_V = 1$		14		μs
Channel Separation	CS	$V_{IN} = 10\text{ V p-p}, f = 10\text{ kHz}, R_L = 10\text{ k}\Omega, C_L = 50\text{ pF}$		98		dB
EMI Rejection Ratio of +IN/+IN x	EMIRR	$V_{IN} = 100\text{ mV peak}, f = 400\text{ MHz}$ $V_{IN} = 100\text{ mV peak}, f = 900\text{ MHz}$ $V_{IN} = 100\text{ mV peak}, f = 1800\text{ MHz}$ $V_{IN} = 100\text{ mV peak}, f = 2400\text{ MHz}$		72		dB
				80		dB
				83		dB
				85		dB
NOISE PERFORMANCE						
Total Harmonic Distortion Plus Noise	THD + N	$A_V = 1, f = 1\text{ kHz}, V_{IN} = 6\text{ V rms}$				
BW = 80 kHz				0.0005		%
BW = 500 kHz				0.004		%
Peak-to-Peak Voltage Noise	$e_{N\text{ p-p}}$	$A_V = 100, f = 0.1\text{ Hz to }10\text{ Hz}$		117		nV p-p
Voltage Noise Density	e_N	$A_V = 100, f = 1\text{ kHz}$		5.8		nV/ $\sqrt{\text{Hz}}$
Peak-to-Peak Current Noise	$i_{N\text{ p-p}}$	$A_V = 100, f = 0.1\text{ Hz to }10\text{ Hz}$		16		pA p-p
Current Noise Density	i_N	$A_V = 100, f = 1\text{ kHz}$		0.8		pA/ $\sqrt{\text{Hz}}$

ELECTRICAL CHARACTERISTICS—55 V OPERATION

$V_{SY} = 55\text{ V}, V_{CM} = V_{SY}/2\text{ V}, T_A = 25^\circ\text{C}$, unless otherwise specified.

Table 4.

Parameter	Symbol	Test Conditions/Comments	Min	Typ	Max	Unit
INPUT CHARACTERISTICS						
Offset Voltage	V_{OS}	$V_{CM} = V_{SY}/2$ $-40^\circ\text{C} \leq T_A \leq +125^\circ\text{C}$		1.5	7	μV
Offset Voltage Drift	TCV_{OS}	ADA4522-1, ADA4522-2 ADA4522-4		6	30	nV/ $^\circ\text{C}$
Input Bias Current	I_B	$-40^\circ\text{C} \leq T_A \leq +85^\circ\text{C}$ $-40^\circ\text{C} \leq T_A \leq +125^\circ\text{C}$		9	40	nV/ $^\circ\text{C}$
Input Offset Current	I_{OS}	$-40^\circ\text{C} \leq T_A \leq +85^\circ\text{C}$ ADA4522-1, ADA4522-2, $-40^\circ\text{C} \leq T_A \leq +125^\circ\text{C}$ ADA4522-4, $-40^\circ\text{C} \leq T_A \leq +125^\circ\text{C}$		50	150	pA
					500	pA
					4.5	nA
				80	300	pA
					400	pA
					500	pA
					550	pA

Parameter	Symbol	Test Conditions/Comments	Min	Typ	Max	Unit
Input Voltage Range	IVR		0		53.5	V
Common-Mode Rejection Ratio	CMRR	$V_{CM} = 0\text{ V to }53.5\text{ V}$ $-40^{\circ}\text{C} \leq T_A \leq +125^{\circ}\text{C}$	140	144		dB
Large Signal Voltage Gain	A_V	$R_L = 10\text{ k}\Omega$, $V_{OUT} = 0.5\text{ V to }54.5\text{ V}$ $-40^{\circ}\text{C} \leq T_A \leq +125^{\circ}\text{C}$	135	137		dB
Input Resistance						
Differential Mode	R_{INDM}			30		k Ω
Common Mode	R_{INCM}			1000		G Ω
Input Capacitance						
Differential Mode	C_{INDM}			7		pF
Common Mode	C_{INCM}			35		pF
OUTPUT CHARACTERISTICS						
Output Voltage						
High	V_{OH}	$R_L = 10\text{ k}\Omega$ to $V_{SY}/2$ $-40^{\circ}\text{C} \leq T_A \leq +125^{\circ}\text{C}$	54.75	54.8		V
Low	V_{OL}	$R_L = 10\text{ k}\Omega$ to $V_{SY}/2$ $-40^{\circ}\text{C} \leq T_A \leq +125^{\circ}\text{C}$	54.65	200	250	mV
Continuous Output Current	I_{OUT}	Dropout voltage = 1 V		14		mA
Short-Circuit Current Source	I_{SC+}	$T_A = 125^{\circ}\text{C}$		21		mA
Short-Circuit Current Sink	I_{SC-}	$T_A = 125^{\circ}\text{C}$		15		mA
Closed-Loop Output Impedance	Z_{OUT}	$f = 1\text{ MHz}$, $A_V = 1$		22		mA
POWER SUPPLY						
Power Supply Rejection Ratio	PSRR	$V_{SY} = 4.5\text{ V to }55\text{ V}$ $-40^{\circ}\text{C} \leq T_A \leq +125^{\circ}\text{C}$	150	160		dB
Supply Current per Amplifier	I_{SY}	ADA4522-2, ADA4522-4, $I_{OUT} = 0\text{ mA}$ ADA4522-2, ADA4522-4, $-40^{\circ}\text{C} \leq T_A \leq +125^{\circ}\text{C}$ ADA4522-1, $I_{OUT} = 0\text{ mA}$ ADA4522-1, $-40^{\circ}\text{C} \leq T_A \leq +125^{\circ}\text{C}$	145	830	900	μA
DYNAMIC PERFORMANCE						
Slew Rate	SR+	$R_L = 10\text{ k}\Omega$, $C_L = 50\text{ pF}$, $A_V = 1$		1.7		V/ μs
	SR-	$R_L = 10\text{ k}\Omega$, $C_L = 50\text{ pF}$, $A_V = 1$		0.8		V/ μs
Gain Bandwidth Product	GBP	$V_{IN} = 10\text{ mV p-p}$, $R_L = 10\text{ k}\Omega$, $C_L = 50\text{ pF}$, $A_V = 100$		2.7		MHz
Unity-Gain Crossover	UGC	$V_{IN} = 10\text{ mV p-p}$, $R_L = 10\text{ k}\Omega$, $C_L = 50\text{ pF}$, $A_V = 1$		3		MHz
-3 dB Closed-Loop Bandwidth	$f_{-3\text{ dB}}$	$V_{IN} = 10\text{ mV p-p}$, $R_L = 10\text{ k}\Omega$, $C_L = 50\text{ pF}$, $A_V = 1$		6.5		MHz
Phase Margin	Φ_M	$V_{IN} = 10\text{ mV p-p}$, $R_L = 10\text{ k}\Omega$, $C_L = 50\text{ pF}$, $A_V = 1$		64		Degrees
Settling Time to 0.1%	t_s	$V_{IN} = 10\text{ V step}$, $R_L = 10\text{ k}\Omega$, $C_L = 50\text{ pF}$, $A_V = 1$		12		μs
Settling Time to 0.01%	t_s	$V_{IN} = 10\text{ V step}$, $R_L = 10\text{ k}\Omega$, $C_L = 50\text{ pF}$, $A_V = 1$		14		μs
Channel Separation	CS	$V_{IN} = 10\text{ V p-p}$, $f = 10\text{ kHz}$, $R_L = 10\text{ k}\Omega$, $C_L = 50\text{ pF}$		98		dB
EMI Rejection Ratio of +IN/+IN x	EMIRR	$V_{IN} = 100\text{ mV peak}$, $f = 400\text{ MHz}$ $V_{IN} = 100\text{ mV peak}$, $f = 900\text{ MHz}$ $V_{IN} = 100\text{ mV peak}$, $f = 1800\text{ MHz}$ $V_{IN} = 100\text{ mV peak}$, $f = 2400\text{ MHz}$		72		dB
NOISE PERFORMANCE						
Total Harmonic Distortion Plus Noise	THD + N	$A_V = 1$, $f = 1\text{ kHz}$, $V_{IN} = 10\text{ V rms}$		0.0007		%
BW = 80 kHz				0.003		%
BW = 500 kHz						
Peak-to-Peak Voltage Noise	$e_{N\text{ p-p}}$	$A_V = 100$, $f = 0.1\text{ Hz to }10\text{ Hz}$		117		nV p-p
Voltage Noise Density	e_N	$A_V = 100$, $f = 1\text{ kHz}$		5.8		nV/ $\sqrt{\text{Hz}}$
Peak-to-Peak Current Noise	$i_{N\text{ p-p}}$	$A_V = 100$, $f = 0.1\text{ Hz to }10\text{ Hz}$		16		pA p-p
Current Noise Density	i_N	$A_V = 100$, $f = 1\text{ kHz}$		0.8		pA/ $\sqrt{\text{Hz}}$

ABSOLUTE MAXIMUM RATINGS

Table 5.

Parameter	Rating
Supply Voltage	60 V
Input Voltage	(V ₋) – 300 mV to (V ₊) + 300 mV
Input Current ¹	±10 mA
Differential Input Voltage	±5 V
Output Short-Circuit Duration to Ground	Indefinite
Temperature Range	
Storage	–65°C to +150°C
Operating	–40°C to +125°C
Junction	–65°C to +150°C
Lead Temperature (Soldering, 60 sec)	300°C

¹ The input pins have clamp diodes to the power supply pins. Limit the input current to ±10 mA or less whenever input signals exceed the power supply rail by 300 mV.

Stresses at or above those listed under Absolute Maximum Ratings may cause permanent damage to the product. This is a stress rating only; functional operation of the product at these or any other conditions above those indicated in the operational section of this specification is not implied. Operation beyond the maximum operating conditions for extended periods may affect product reliability.

THERMAL RESISTANCE

θ_{JA} is specified for the worst case conditions, that is, a device soldered in a circuit board for surface-mount packages using a standard 4-layer JEDEC board.

Table 6. Thermal Resistance

Package Type	θ_{JA}	θ_{JC}	Unit
RM-8	194	38	°C/W
R-8	122	41	°C/W
RU-14	112	43	°C/W
R-14	115	36	°C/W

POWER SEQUENCING

Apply the op amp supplies simultaneously; if this is not possible, apply the positive power supply first, before the negative power supply.

ESD CAUTION



ESD (electrostatic discharge) sensitive device. Charged devices and circuit boards can discharge without detection. Although this product features patented or proprietary protection circuitry, damage may occur on devices subjected to high energy ESD. Therefore, proper ESD precautions should be taken to avoid performance degradation or loss of functionality.

PIN CONFIGURATIONS AND FUNCTION DESCRIPTIONS



NOTES
1. NIC = NOT INTERNALLY CONNECTED.

Figure 3. ADA4522-1 Pin Configuration

Table 7. ADA4522-1 Pin Function Descriptions

Pin No.	Mnemonic	Description
1, 5, 8	NIC	Not Internally Connected
2	-IN	Inverting Input
3	+IN	Noninverting Input
4	V-	Negative Supply Voltage
6	OUT	Output
7	V+	Positive Supply Voltage

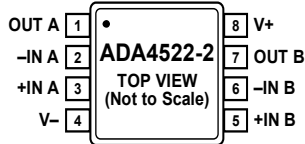

Figure 4. ADA4522-2 Pin Configuration

Table 8. ADA4522-2 Pin Function Descriptions

Pin No.	Mnemonic	Description
1	OUT A	Output, Channel A
2	-IN A	Inverting Input, Channel A
3	+IN A	Noninverting Input, Channel A
4	V-	Negative Supply Voltage
5	+IN B	Noninverting Input, Channel B
6	-IN B	Inverting Input, Channel B
7	OUT B	Output, Channel B
8	V+	Positive Supply Voltage

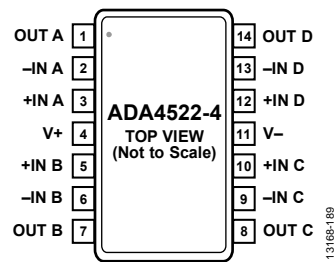

Figure 5. ADA4522-4 Pin Configuration

Table 9. ADA4522-4 Pin Function Descriptions

Pin No.	Mnemonic	Description
1	OUT A	Output, Channel A
2	-IN A	Inverting Input, Channel A
3	+IN A	Noninverting Input, Channel A
4	V+	Positive Supply Voltage
5	+IN B	Noninverting Input, Channel B
6	-IN B	Inverting Input, Channel B
7	OUT B	Output, Channel B
8	OUT C	Output, Channel C
9	-IN C	Inverting Input, Channel C
10	+IN C	Noninverting Input, Channel C
11	V-	Negative Supply Voltage
12	+IN D	Noninverting Input, Channel D
13	-IN D	Inverting Input, Channel D
14	OUT D	Output, Channel D

TYPICAL PERFORMANCE CHARACTERISTICS

T_A = 25°C, unless otherwise noted.

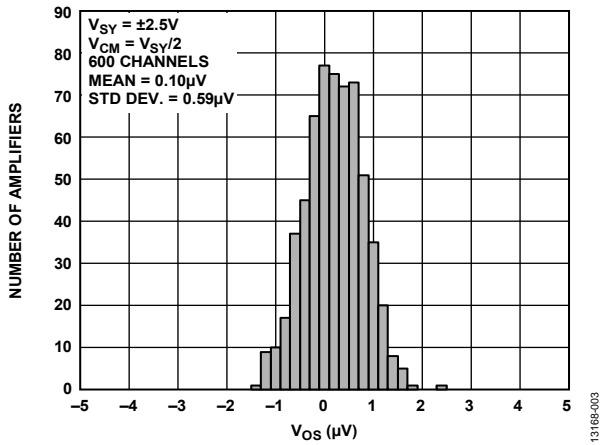

Figure 6. Input Offset Voltage Distribution, V_{SY} = ±2.5 V

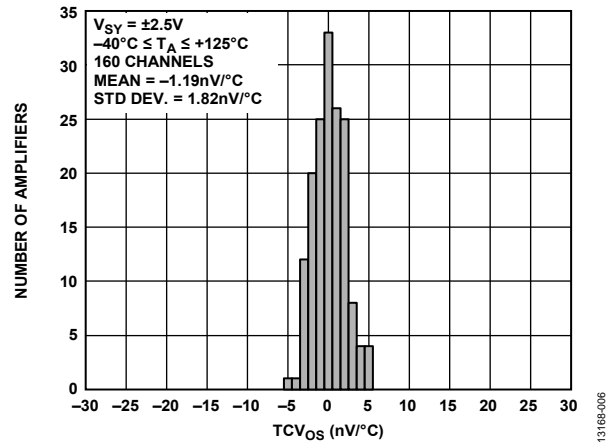

Figure 9. Input Offset Voltage Drift Distribution, V_{SY} = ±2.5 V

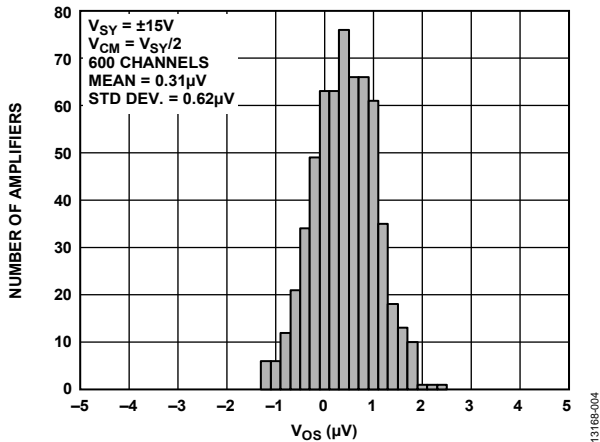

Figure 7. Input Offset Voltage Distribution, V_{SY} = ±15 V

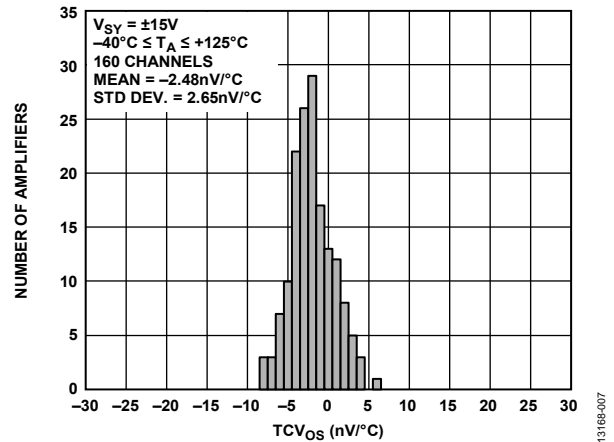

Figure 10. Input Offset Voltage Drift Distribution, V_{SY} = ±15 V

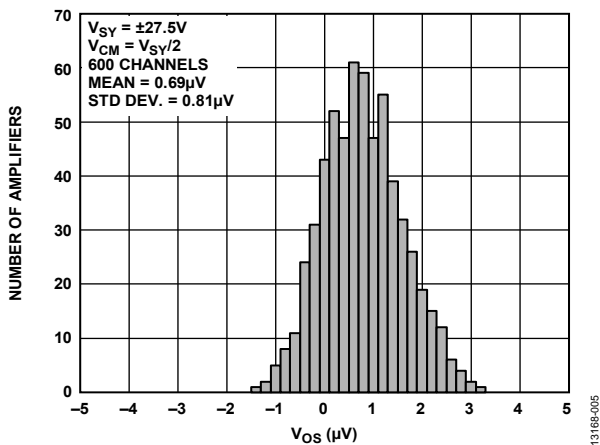

Figure 8. Input Offset Voltage Distribution, V_{SY} = ±27.5 V

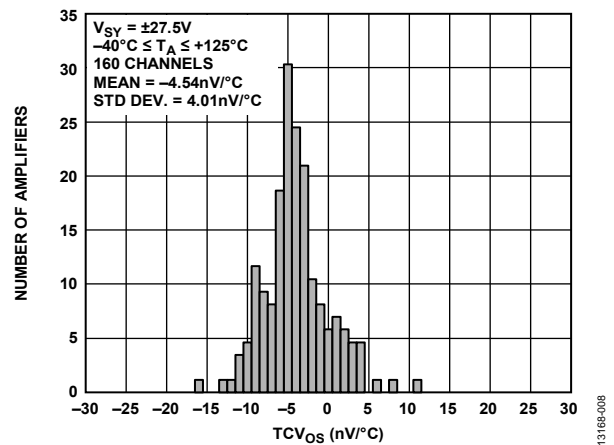

Figure 11. Input Offset Voltage Drift Distribution, V_{SY} = ±27.5 V

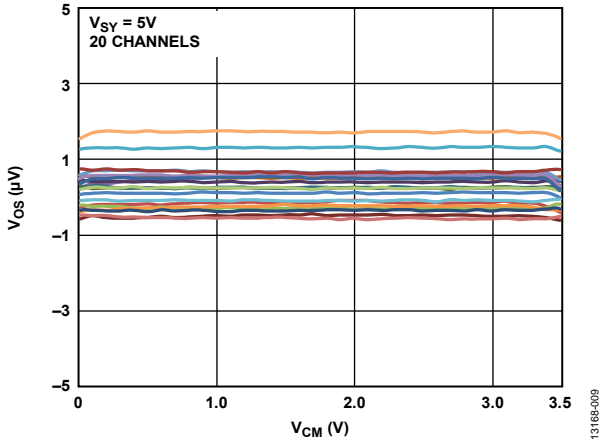

Figure 12. Input Offset Voltage (V_{OS}) vs. Common-Mode Voltage (V_{CM}), $V_{SY} = 5\text{ V}$

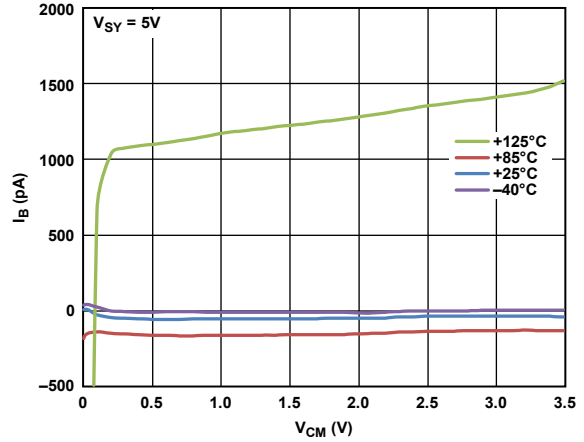

Figure 15. Input Bias Current (I_B) vs. Common-Mode Voltage (V_{CM}), $V_{SY} = 5\text{ V}$

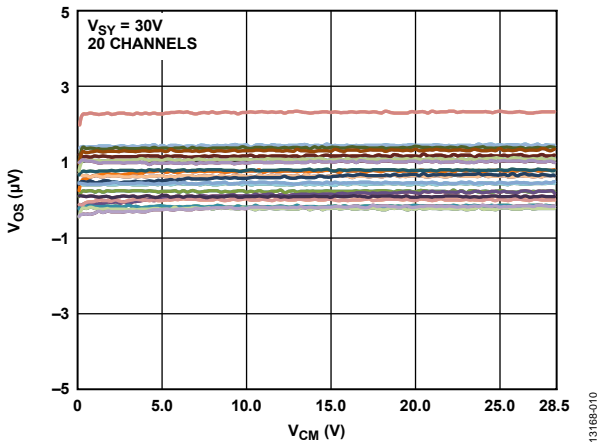

Figure 13. Input Offset Voltage (V_{OS}) vs. Common-Mode Voltage (V_{CM}), $V_{SY} = 30\text{ V}$

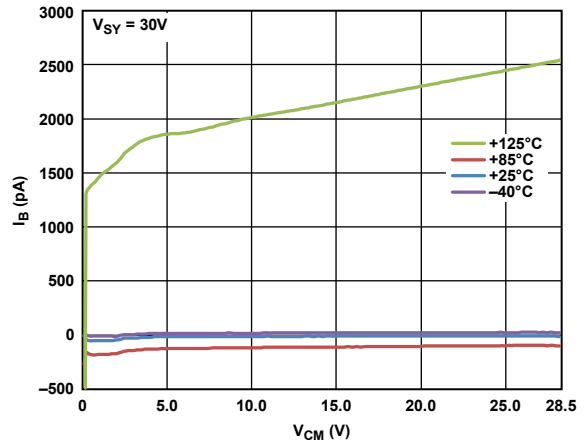

Figure 16. Input Bias Current (I_B) vs. Common-Mode Voltage (V_{CM}), $V_{SY} = 30\text{ V}$

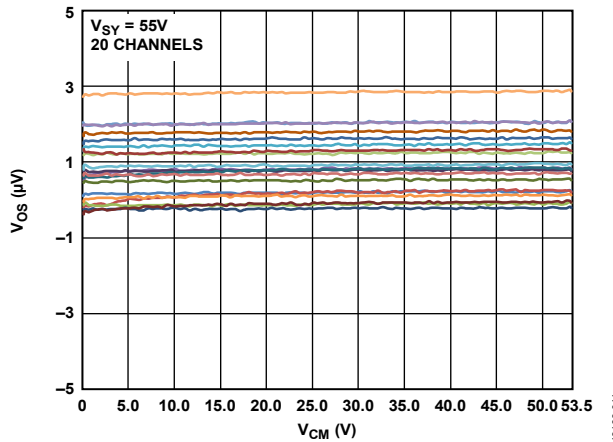

Figure 14. Input Offset Voltage (V_{OS}) vs. Common-Mode Voltage (V_{CM}), $V_{SY} = 55\text{ V}$

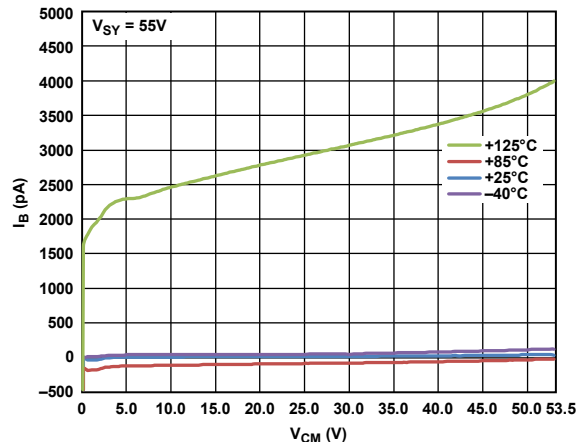

Figure 17. Input Bias Current (I_B) vs. Common-Mode Voltage (V_{CM}), $V_{SY} = 55\text{ V}$

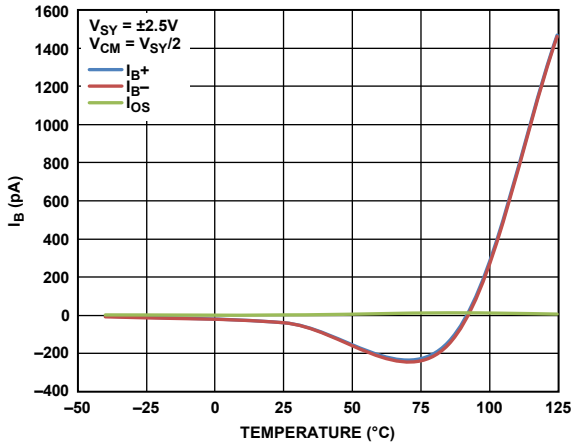

Figure 18. Input Bias Current (I_B) vs. Temperature, $V_{SY} = \pm 2.5 V$

13168-015

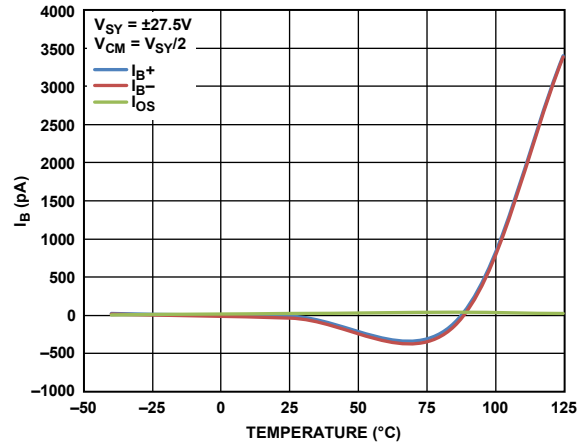

Figure 21. Input Bias Current (I_B) vs. Temperature, $V_{SY} = \pm 27.5 V$

13168-016

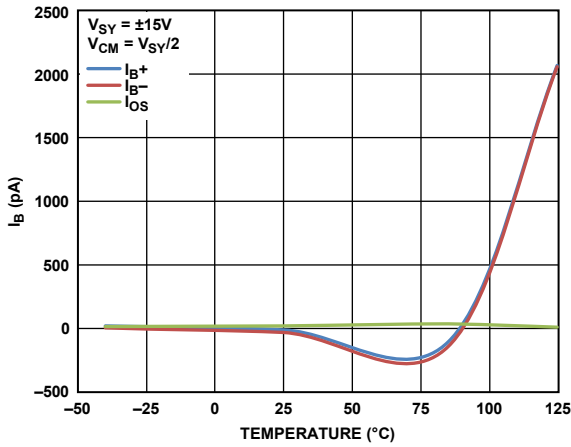

Figure 19. Input Bias Current (I_B) vs. Temperature, $V_{SY} = \pm 15 V$

13168-017

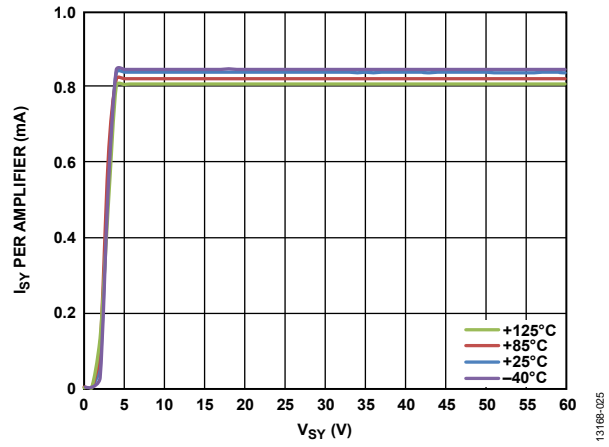

Figure 22. Supply Current (I_{SY}) per Amplifier vs. Supply Voltage (V_{SY})

13168-025

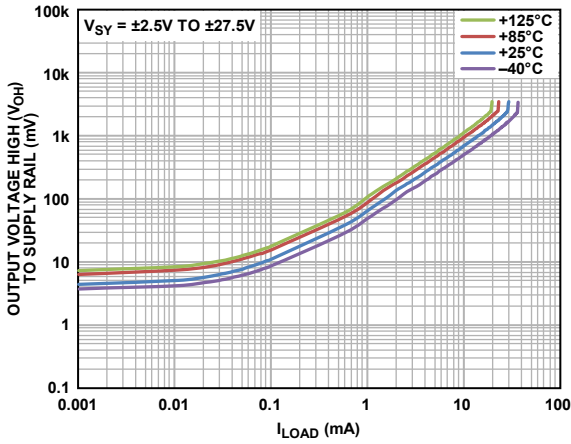

Figure 20. Output Voltage High (V_{OH}) to Supply Rail vs. Load Current (I_{LOAD})

13168-024

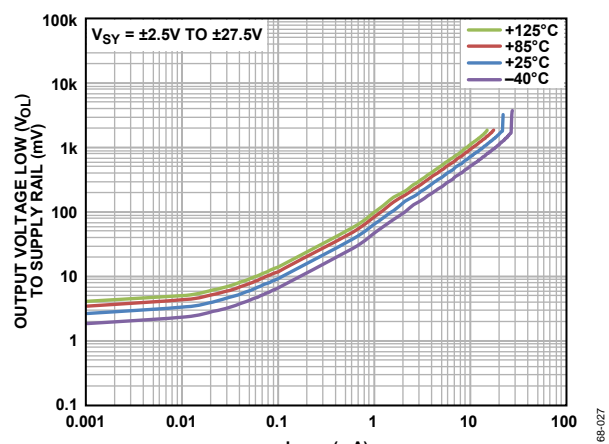

Figure 23. Output Voltage Low (V_{OL}) to Supply Rail vs. Load Current (I_{LOAD})

13168-027

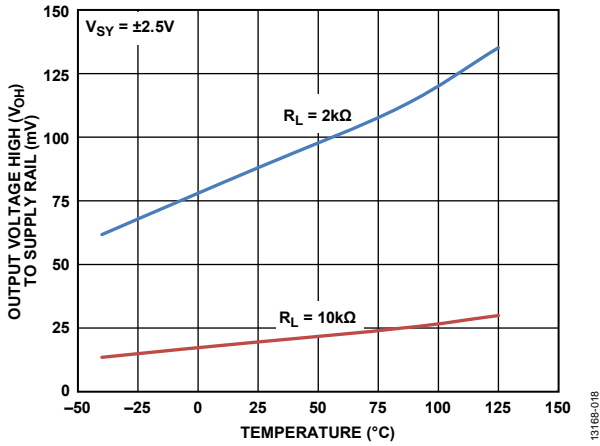

Figure 24. Output Voltage High (V_{OH}) to Supply Rail vs. Temperature, $V_{SY} = \pm 2.5 V$

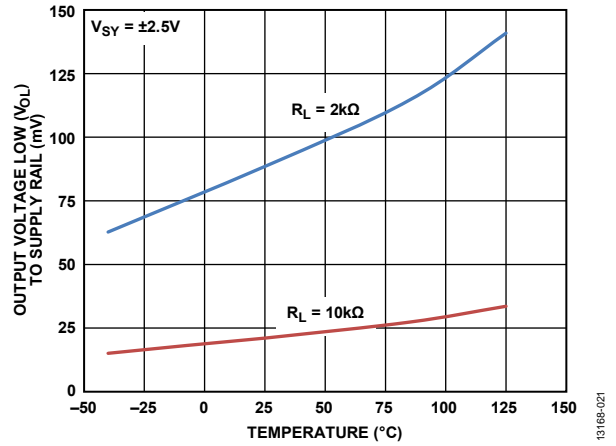

Figure 27. Output Voltage Low (V_{OL}) to Supply Rail vs. Temperature, $V_{SY} = \pm 2.5 V$

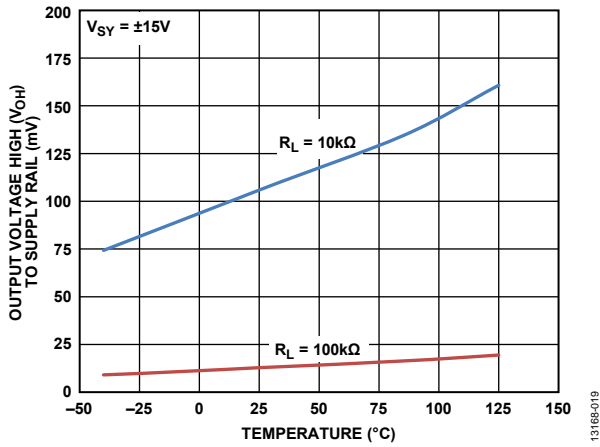

Figure 25. Output Voltage High (V_{OH}) to Supply Rail vs. Temperature, $V_{SY} = \pm 15 V$

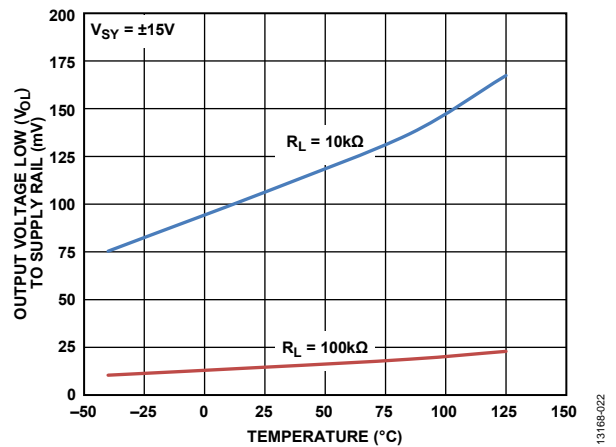

Figure 28. Output Voltage Low (V_{OL}) to Supply Rail vs. Temperature, $V_{SY} = \pm 15 V$

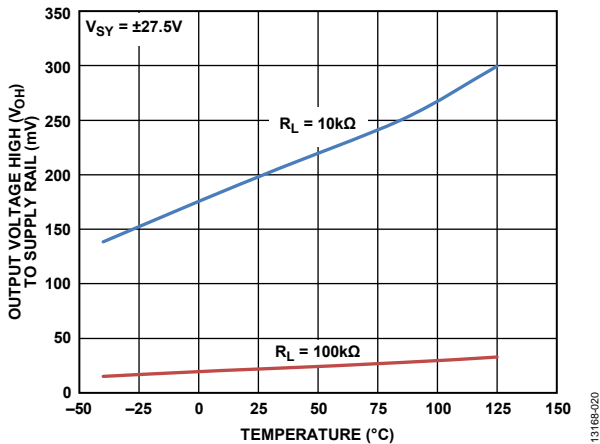

Figure 26. Output Voltage High (V_{OH}) to Supply Rail vs. Temperature, $V_{SY} = \pm 27.5 V$

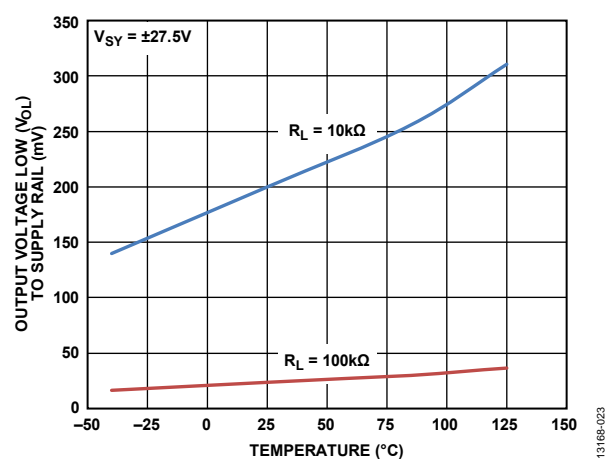

Figure 29. Output Voltage Low (V_{OL}) to Supply Rail vs. Temperature, $V_{SY} = \pm 27.5 V$

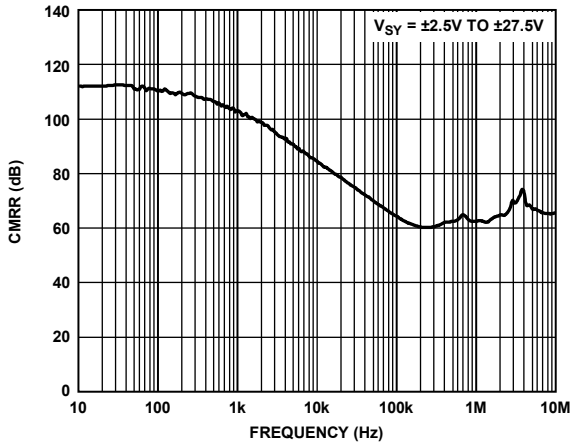

Figure 30. CMRR vs. Frequency

13168-030

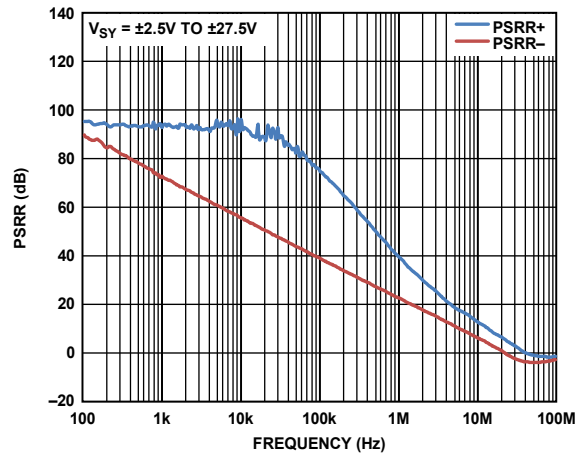

Figure 33. PSRR vs. Frequency

13168-032

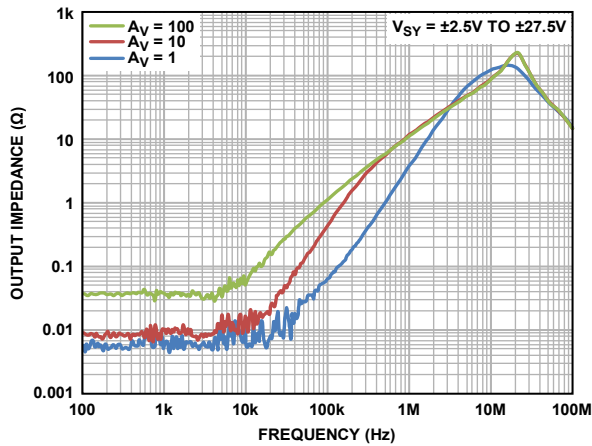

Figure 31. Closed-Loop Output Impedance vs. Frequency

13168-031

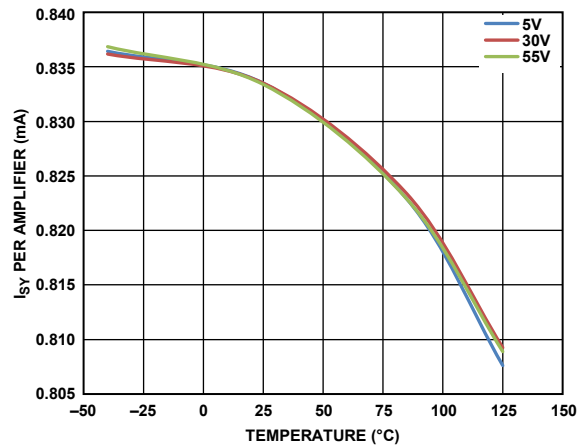

Figure 34. Supply Current (I_{SY}) per Amplifier vs. Temperature

13168-028

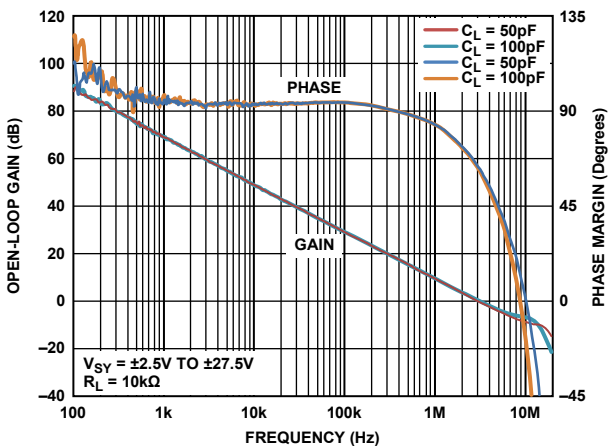

Figure 32. Open-Loop Gain and Phase Margin vs. Frequency

13168-026

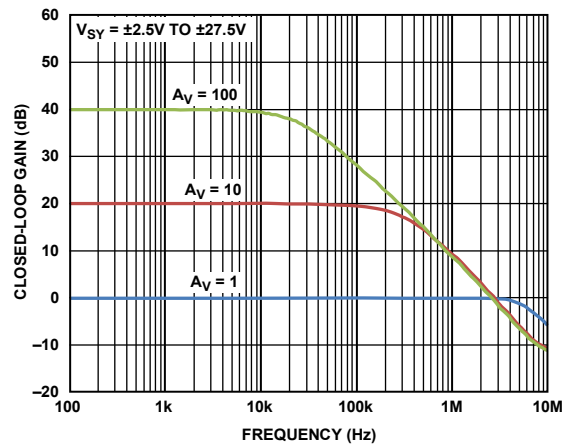

Figure 35. Closed-Loop Gain vs. Frequency

13168-133

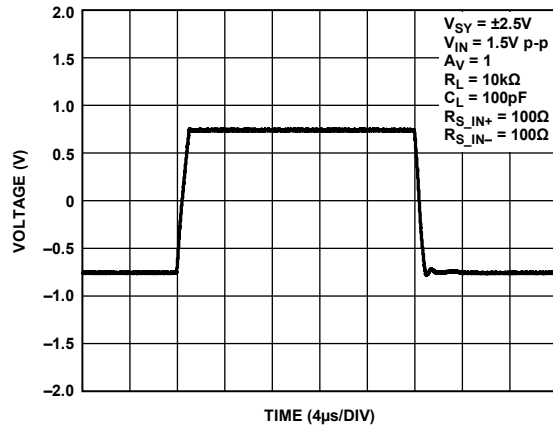

Figure 36. Large Signal Transient Response, $V_{SY} = \pm 2.5 V$

13168-034

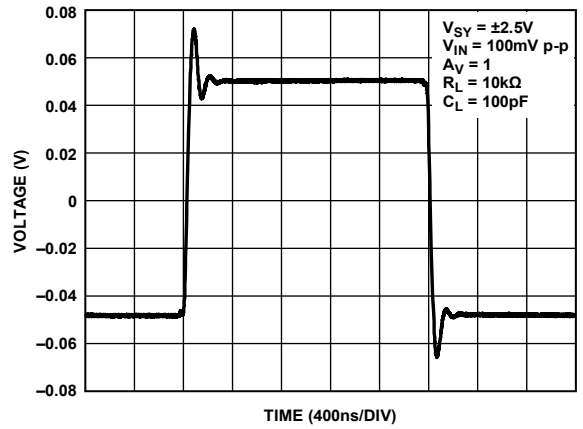

Figure 39. Small Signal Transient Response, $V_{SY} = \pm 2.5 V$

13168-037

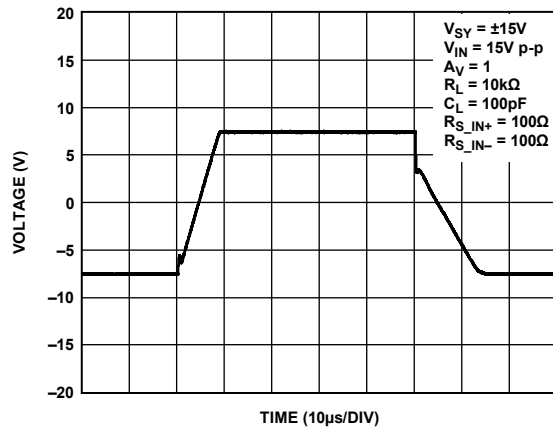

Figure 37. Large Signal Transient Response, $V_{SY} = \pm 15 V$

13168-035

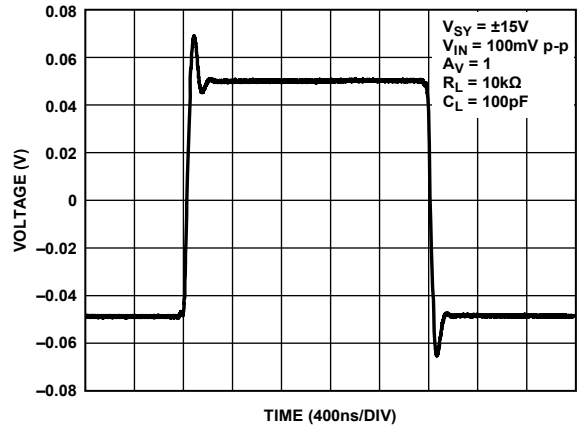

Figure 40. Small Signal Transient Response, $V_{SY} = \pm 15 V$

13168-038

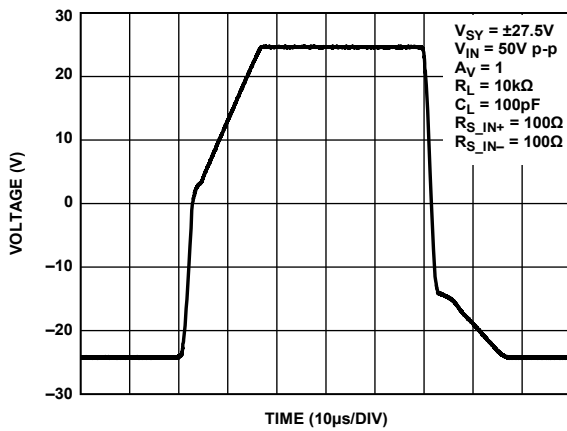

Figure 38. Large Signal Transient Response, $V_{SY} = \pm 27.5 V$

13168-036

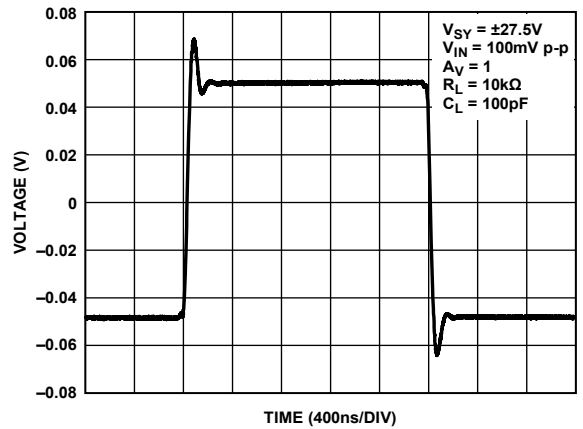

Figure 41. Small Signal Transient Response, $V_{SY} = \pm 27.5 V$

13168-039

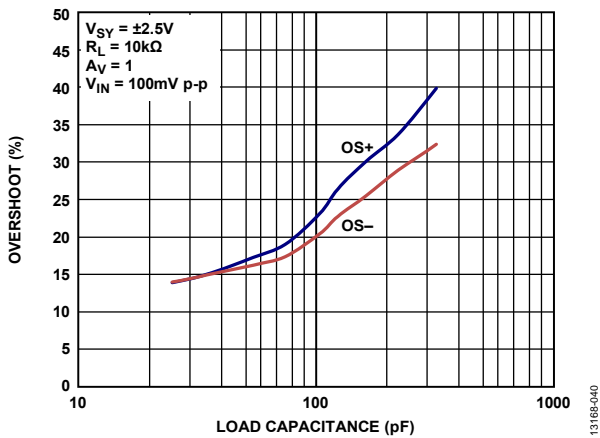

Figure 42. Small Signal Overshoot vs. Load Capacitance, $V_{SY} = \pm 2.5\text{ V}$

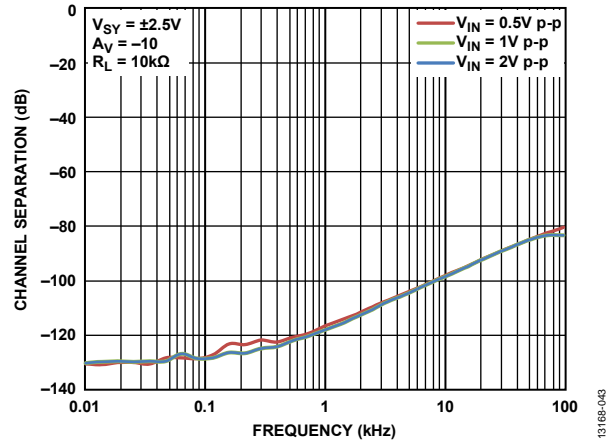

Figure 45. Channel Separation vs. Frequency, $V_{SY} = \pm 2.5\text{ V}$

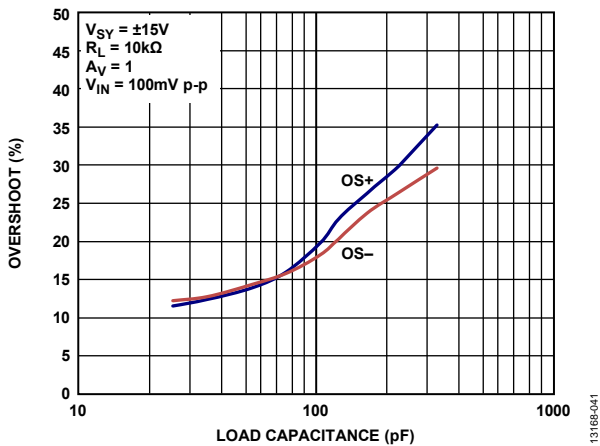

Figure 43. Small Signal Overshoot vs. Load Capacitance, $V_{SY} = \pm 15\text{ V}$

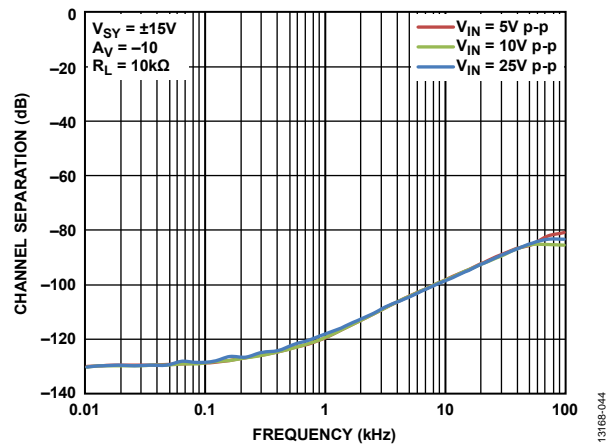

Figure 46. Channel Separation vs. Frequency, $V_{SY} = \pm 15\text{ V}$

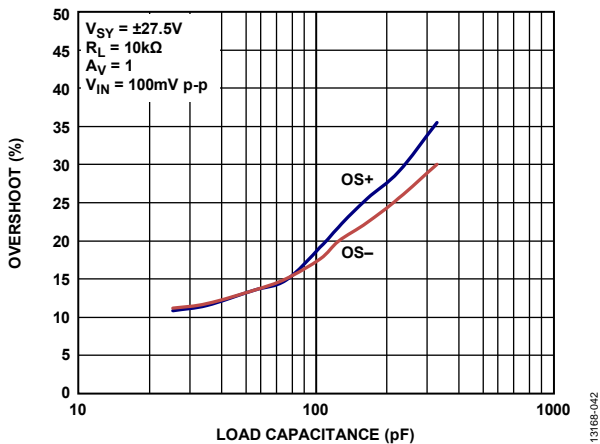

Figure 44. Small Signal Overshoot vs. Load Capacitance, $V_{SY} = \pm 27.5\text{ V}$

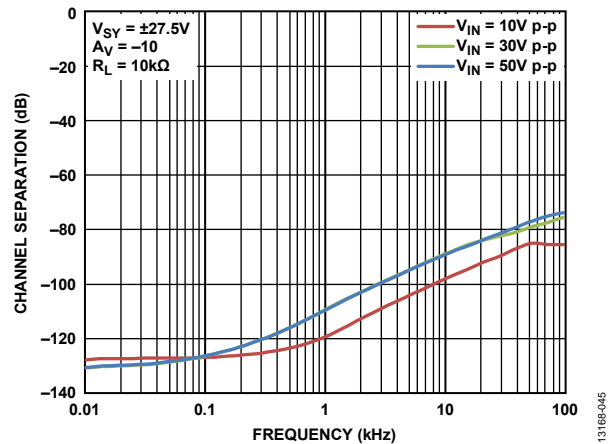

Figure 47. Channel Separation vs. Frequency, $V_{SY} = \pm 27.5\text{ V}$

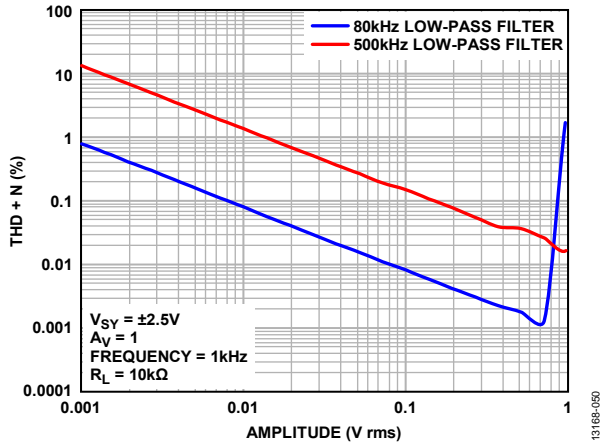

Figure 48. THD + N vs. Amplitude, $V_{SY} = \pm 2.5V$

13168-050

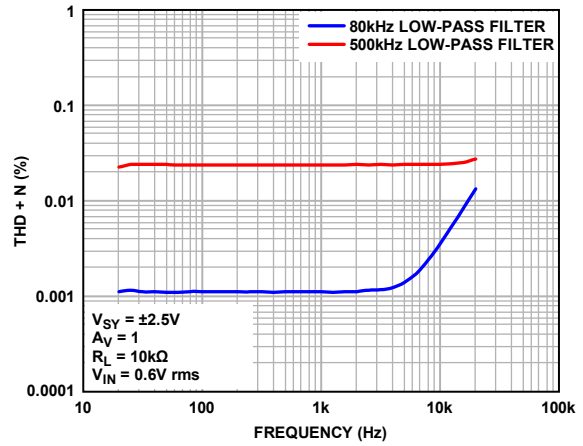

Figure 51. THD + N vs. Frequency, $V_{SY} = \pm 2.5V$

13168-053

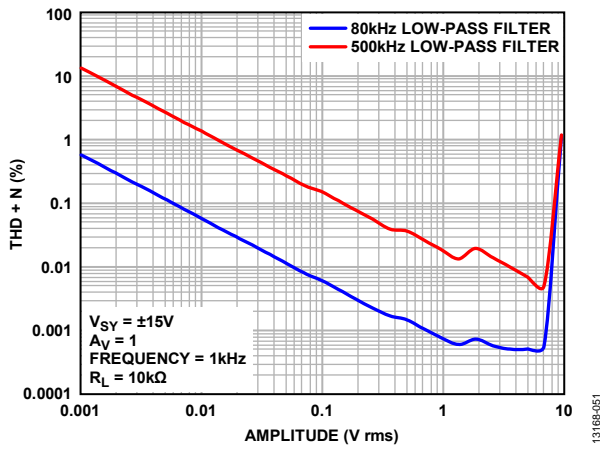

Figure 49. THD + N vs. Amplitude, $V_{SY} = \pm 15V$

13168-051

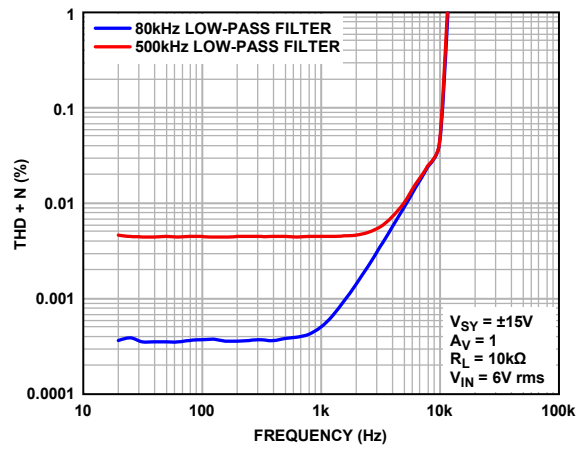

Figure 52. THD + N vs. Frequency, $V_{SY} = \pm 15V$

13168-054

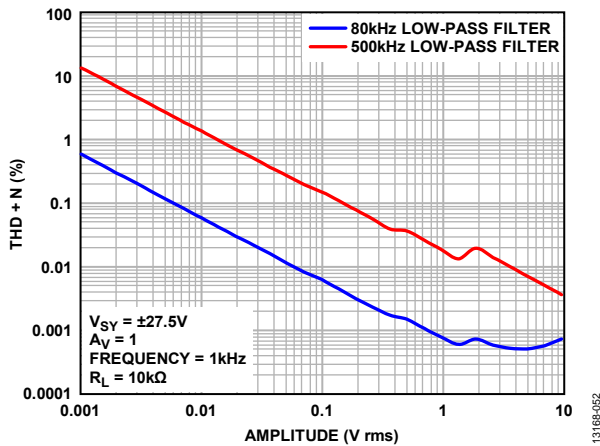

Figure 50. THD + N vs. Amplitude, $V_{SY} = \pm 27.5V$

13168-052

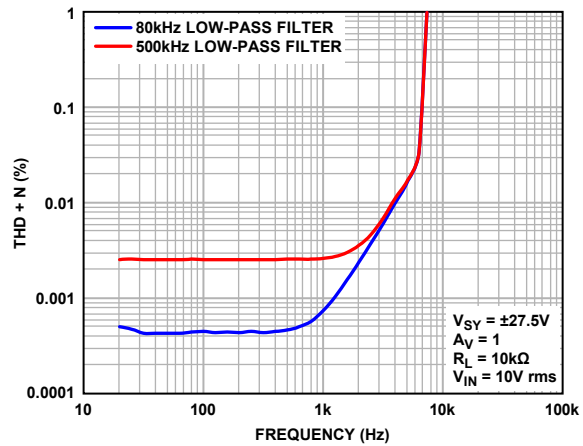

Figure 53. THD + N vs. Frequency, $V_{SY} = \pm 27.5V$

13168-055

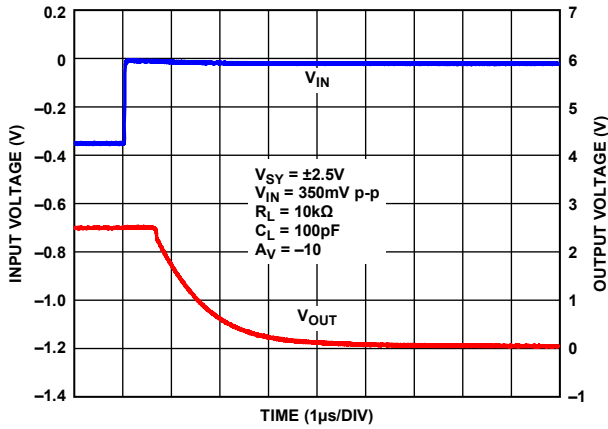

Figure 54. Positive Overload Recovery, $V_{SY} = \pm 2.5V$

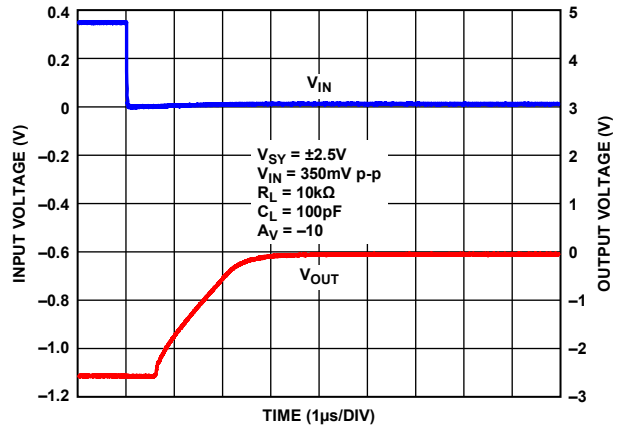

Figure 57. Negative Overload Recovery, $V_{SY} = \pm 2.5V$

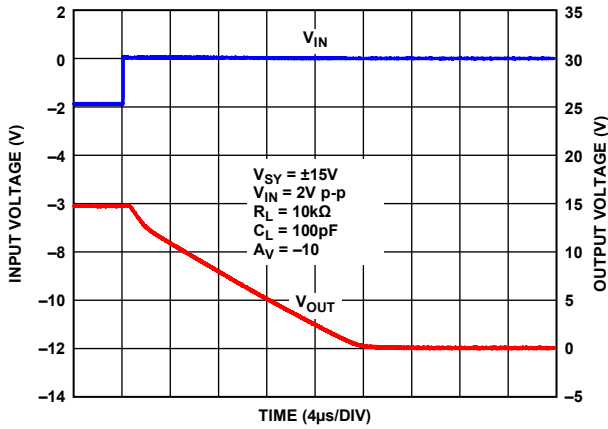

Figure 55. Positive Overload Recovery, $V_{SY} = \pm 15V$

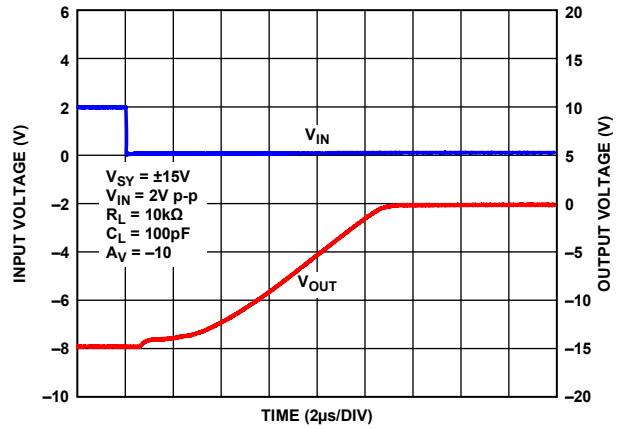

Figure 58. Negative Overload Recovery, $V_{SY} = \pm 15V$

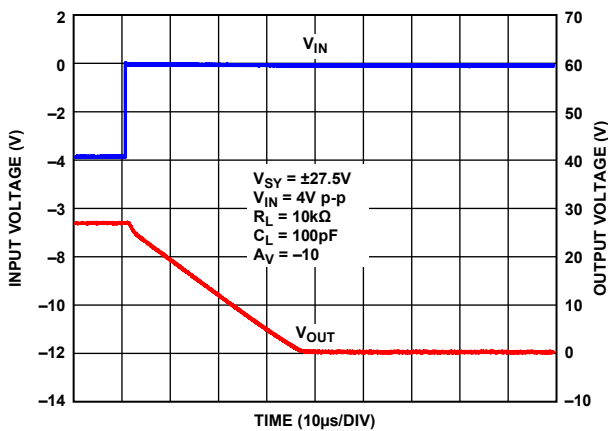

Figure 56. Positive Overload Recovery, $V_{SY} = \pm 27.5V$

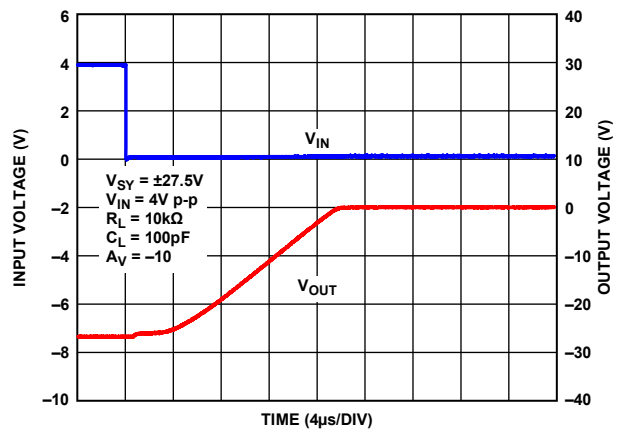

Figure 59. Negative Overload Recovery, $V_{SY} = \pm 27.5V$

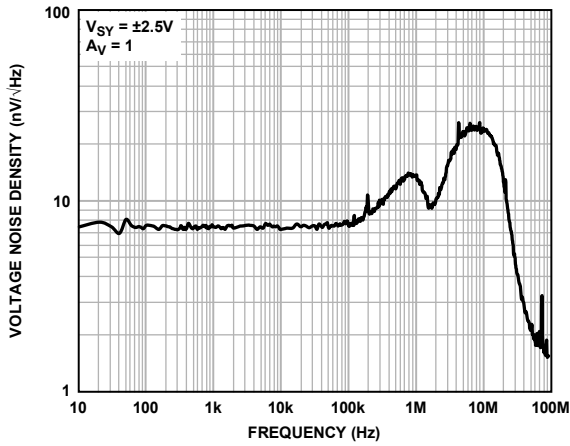

Figure 60. Voltage Noise Density vs. Frequency, $V_{SY} = \pm 2.5V$

13168-062

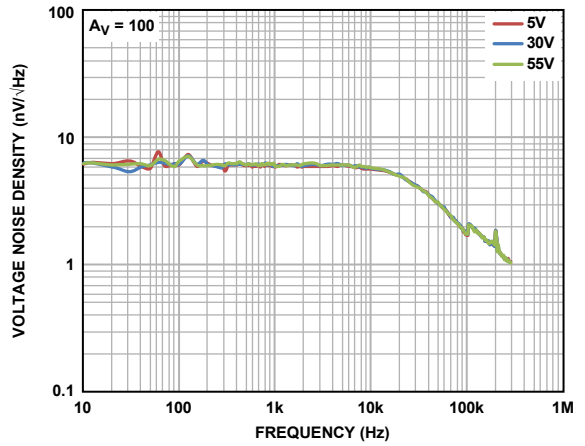

Figure 63. Voltage Noise Density vs. Frequency, $A_V = 100$

13168-065

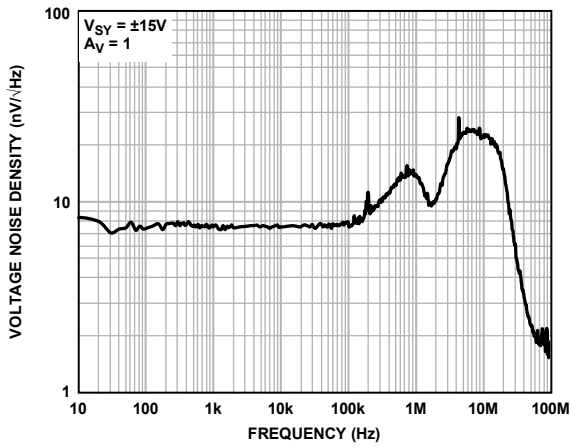

Figure 61. Voltage Noise Density vs. Frequency, $V_{SY} = \pm 15V$

13168-063

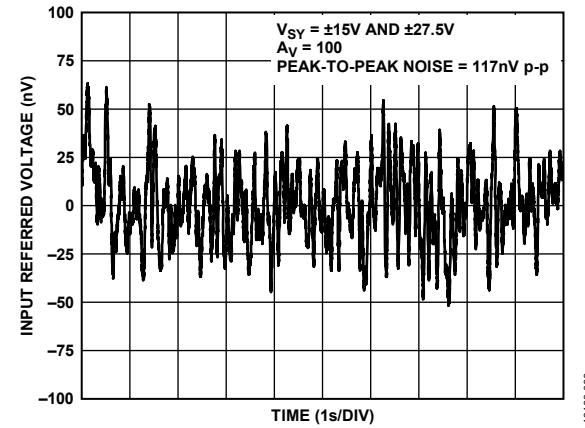

Figure 64. 0.1 Hz to 10 Hz Noise

13168-066

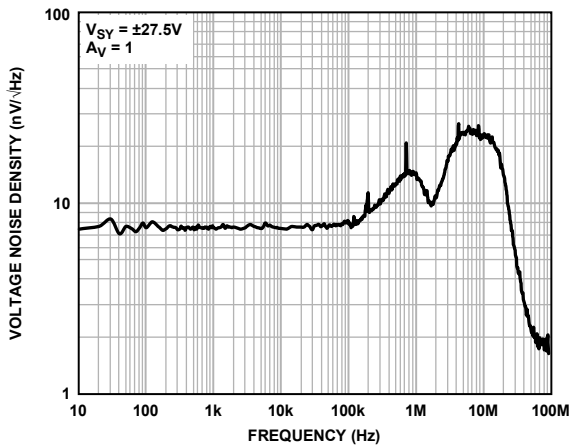

Figure 62. Voltage Noise Density vs. Frequency, $V_{SY} = \pm 27.5V$

13168-064

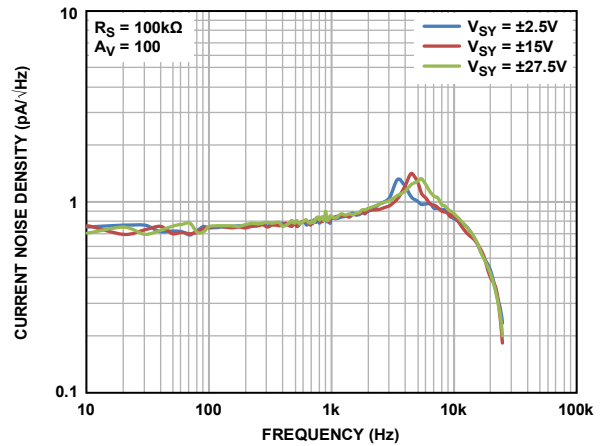

Figure 65. Current Noise Density vs. Frequency

13168-067

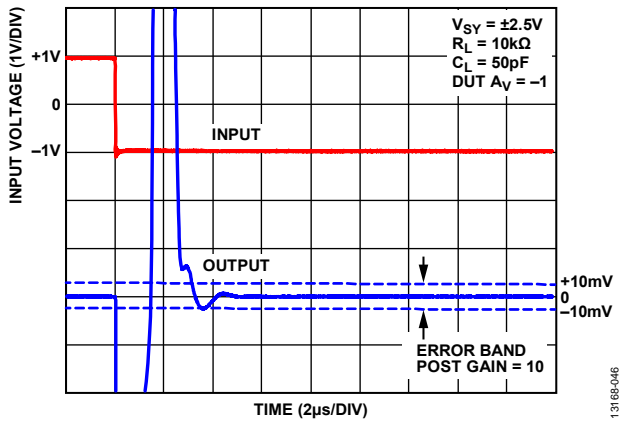

Figure 66. Negative Settling Time to 0.1%, $V_{SY} = \pm 2.5V$

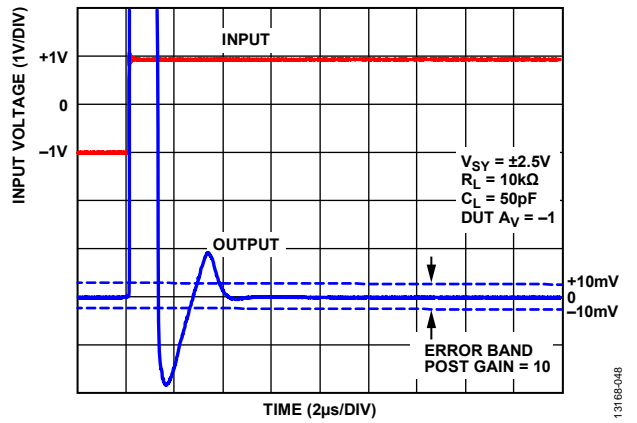

Figure 69. Positive Settling Time to 0.1%, $V_{SY} = \pm 2.5V$

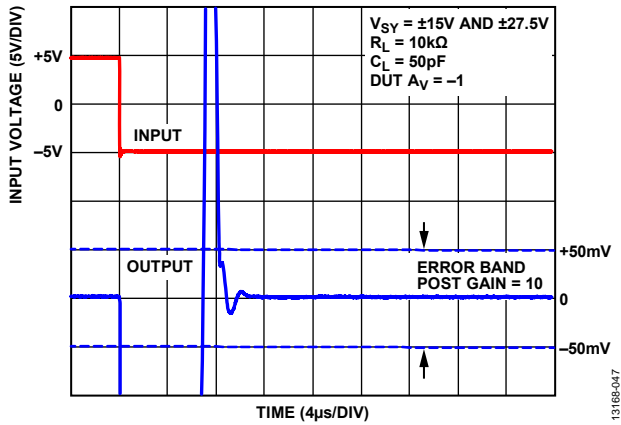

Figure 67. Negative Settling Time to 0.1%, $V_{SY} = \pm 15V$ and $\pm 27.5V$

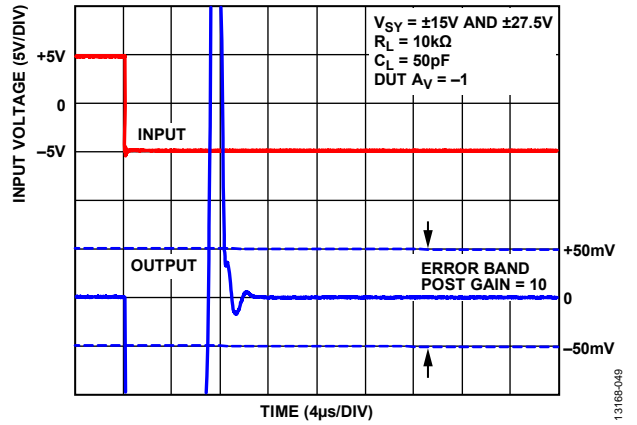

Figure 70. Positive Settling Time to 0.1%, $V_{SY} = \pm 15V$ and $\pm 27.5V$

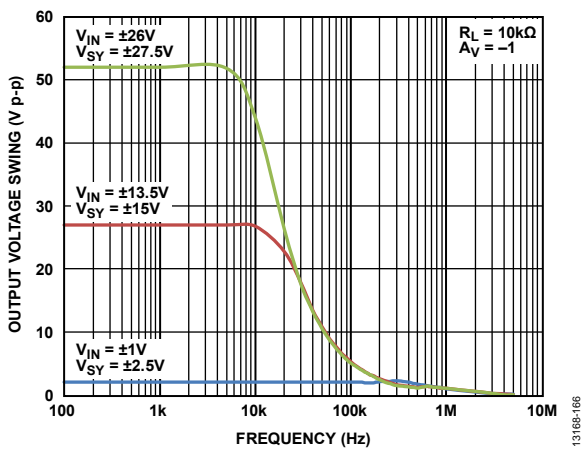

Figure 68. Output Voltage Swing vs. Frequency

13168-046

13168-048

13168-047

13168-049

13168-166

THEORY OF OPERATION

The ADA4522-1/ADA4522-2/ADA4522-4 are single, dual, and quad, ultralow noise, high voltage, zero drift, rail-to-rail output operational amplifiers. They feature a chopping technique that offers an ultralow input offset voltage of 5 μV and an input offset voltage drift of 22 nV/ $^{\circ}\text{C}$ maximum for the ADA4522-1 and ADA4522-2 and 25 nV/ $^{\circ}\text{C}$ maximum for the ADA4522-4. Offset voltage errors due to common-mode voltage swings and power supply variations are also corrected by the chopping technique, resulting in a superb typical CMRR figure of 160 dB and a PSRR figure of 160 dB at a 30 V supply voltage.

The ADA4522-1/ADA4522-2/ADA4522-4 have wide operating voltages from $\pm 2.25\text{ V}$ (or 4.5 V) to $\pm 27.5\text{ V}$ (or 55 V). The devices are single supply amplifiers, where their input voltage range includes the lower supply rail. They also offer low voltage noise density of 5.8 nV/ $\sqrt{\text{Hz}}$ (at $f = 1\text{ kHz}$, $A_V = 100$) and reduced 1/f noise component. These features are ideal for the amplification of low level signals in high precision applications. A few examples of such applications are weigh scales, high precision current sensing, high voltage buffers, and signal conditioning for temperature sensors, among others.

Figure 71 shows the ADA4522-1/ADA4522-2/ADA4522-4 architecture block diagram. The architecture consists of an input EMI filter and clamp circuitry, three gain stages (G_{m1} , G_{m2} , and G_{m3}), input and output chopping networks (CHOP_{IN} and

CHOP_{OUT}), a clock generator, offset and ripple correction loop circuitry, frequency compensation capacitors (C1, C2, and C3), and thermal shutdown circuitry.

An EMI filter and clamp circuit is implemented at the input front end to protect the internal circuitry against electrostatic discharge (ESD) stresses and high voltage transients. The ability of the amplifier to reject EMI is explained in detail in the EMI Rejection Ratio section.

CHOP_{IN} and CHOP_{OUT} are controlled by a clock generator and operate at 4.8 MHz. The input baseband signal is initially modulated by CHOP_{IN}. Next, CHOP_{OUT} demodulates the input signal and modulates the millivolt level input offset voltage and 1/f noise of the input transconductance amplifier, G_{m1} , to the chopping frequency at 4.8 MHz. The chopping networks remove the low frequency errors, but, in return, the networks introduce chopping artifacts at the chopping frequency. Therefore, an offset and ripple correction loop, operating at 800 kHz, is used. This frequency is the switching frequency of the amplifier. This circuitry reduces chopping artifacts, allowing the ADA4522-1/ADA4522-2/ADA4522-4 to have a high chopping frequency with minimal artifacts.

The thermal shutdown circuit shuts down the circuit when the die is overheated (see the Thermal Shutdown section for more information).

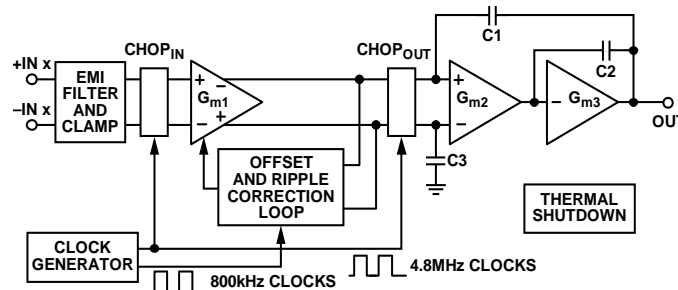

NOTES

1. THE INPUTS ARE +IN x/-IN x ON THE ADA4522-2 AND ADA4522-4, AND +IN/-IN ON THE ADA4522-1.
2. THE OUTPUT IS OUT ON THE ADA4522-1 AND OUT x ON THE ADA4522-2 AND ADA4522-4.

Figure 71. ADA4522-1/ADA4522-2/ADA4522-4 Architecture Block Diagram

1316B-068

ON-CHIP INPUT EMI FILTER AND CLAMP CIRCUIT

Figure 72 shows the input EMI filter and clamp circuit. The ADA4522-1/ADA4522-2/ADA4522-4 have internal ESD protection diodes (D1, D2, D3, and D4) that are connected between the inputs and each supply rail. These diodes protect the input transistors in the event of electrostatic discharge and are reverse biased during normal operation. This protection scheme allows voltages as high as approximately 300 mV beyond the rails to be applied at the input of either terminal without causing permanent damage. See Table 5 in the Absolute Maximum Ratings section for more information.

The EMI filter is composed of two 200 Ω input series resistors (R_{S1} and R_{S2}), two common-mode capacitors (C_{CM1} and C_{CM2}), and a differential capacitor (C_{DM}). These RC networks set the -3 dB low-pass cutoff frequencies at 50 MHz for common-mode signals, and at 33 MHz for differential signals. After the EMI filter, back to back diodes (D5 and D6) are added to protect internal circuit devices from high voltage input transients. Each diode has about 1 V of forward turn on voltage. See the Large Signal Transient Response section for more information on the effect of high voltage input transient on the ADA4522-1/ADA4522-2/ADA4522-4.

As specified in the Absolute Maximum Ratings section (see Table 5), the maximum input differential voltage is limited to ±5 V. If more than ±5 V is applied, a continuous current larger than ±10 mA flows through one of the back to back diodes. This current compromises long-term reliability and can cause permanent damage to the device.

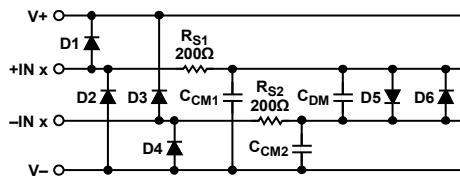

NOTES
1. THE INPUTS ARE +IN x/-IN x ON THE ADA4522-2 AND ADA4522-4, AND +IN/-IN ON THE ADA4522-1.

Figure 72. Input EMI Filter and Clamp Circuit

THERMAL SHUTDOWN

The ADA4522-1/ADA4522-2/ADA4522-4 have internal thermal shutdown circuitry for each channel of the amplifier. The thermal shutdown circuitry prevents internal devices from being damaged by an overheat condition in the die. Overheating can occur due to a high ambient temperature, a high supply voltage, and/or high output currents. As specified in Table 5, take care to maintain the junction temperature below 150°C.

Two conditions affect junction temperature (T_J): the total power dissipation of the device (P_D) and the ambient temperature surrounding the package (T_A). Use the following equation to estimate the approximate junction temperature:

$$T_J = P_D \times \theta_{JA} + T_A \tag{1}$$

where θ_{JA} is the thermal resistance between the die and the ambient environment, as shown in Table 6.

The total power dissipation is the sum of quiescent power of the device and the power required to drive a load for all channels of an amplifier. The power dissipation per amplifier (P_{D,PER_AMP}) for sourcing a load is shown in Equation 2.

$$P_{D,PER_AMP} = (V_{SY+} - V_{SY-}) \times I_{SY_PER_AMP} + I_{OUT} \times (V_{SY+} - V_{OUT}) \tag{2}$$

When sinking current, replace (V_{SY+} - V_{OUT}) in Equation 2 with (V_{OUT} - V_{SY-}).

Also, take note to include the power dissipation of all channels of the amplifier when calculating the total power dissipation for the ADA4522-1/ADA4522-2/ADA4522-4.

The thermal shutdown circuitry does not guarantee the device to be free of permanent damage if the junction temperature exceeds 150°C. However, the internal thermal shutdown function may help avoid permanent damage or reduce the degree of damage. Each amplifier channel has thermal shutdown circuitry, composed of a temperature sensor with hysteresis.

As soon as the junction temperature reaches 190°C, the thermal shutdown circuitry shuts down the amplifier. Note that either one of the two thermal shutdown circuitries is activated; this activation disables the channel. When the amplifier is disabled, the output becomes open state and the quiescent current of the channel decreases to 0.1 mA. When the junction temperature cools down to 160°C, the thermal shutdown circuitry enables the amplifier and the quiescent current increases to its typical value.

When overheating in the die is caused by an undesirable excess amount of output current, the thermal shutdown circuit repeats its function. The junction temperature keeps increasing until it reaches 190°C and one of the channels is disabled. Then, the junction temperature cools down until it reaches 160°C, and the channel is enabled again. The process then repeats.

INPUT PROTECTION

When either input of the ADA4522-1/ADA4522-2/ADA4522-4 exceeds one of the supply rails by more than 300 mV, the ESD diodes mentioned in the On-Chip Input EMI Filter and Clamp Circuit section become forward-biased and large amounts of current begin to flow through them. Without current limiting, this excessive fault current causes permanent damage to the device. If the inputs are expected to be subject to overvoltage conditions, insert a resistor in series with each input to limit the input current to ±10 mA maximum. However, consider the resistor thermal noise effect on the entire circuit.

At a ±15 V supply voltage, the broadband voltage noise of the ADA4522-1/ADA4522-2/ADA4522-4 is approximately 5.8 nV/√Hz (at unity gain), and a 1 kΩ resistor has a thermal noise of 4 nV/√Hz. Adding a 1 kΩ resistor increases the total noise to 7 nV/√Hz.

SINGLE-SUPPLY AND RAIL-TO-RAIL OUTPUT

The ADA4522-1/ADA4522-2/ADA4522-4 are single-supply amplifiers, where their input voltage range includes the lower supply rail. This feature is ideal for applications where the input common-mode voltage is at the lower supply rail, for example, ground sensing. Conversely, the amplifier output is rail to rail. Figure 73 shows the input and output waveforms of the ADA4522-1/ADA4522-2/ADA4522-4 configured as a unity-gain buffer with a supply voltage of ± 15 V. With an input voltage of ± 15 V, the low output voltage tracks the input voltage, whereas the high output swing clamps/distorts when the input goes out of the input voltage range ($-15 \text{ V} \leq \text{IVR} \leq +13.5 \text{ V}$). However, the device does not exhibit phase reversal.

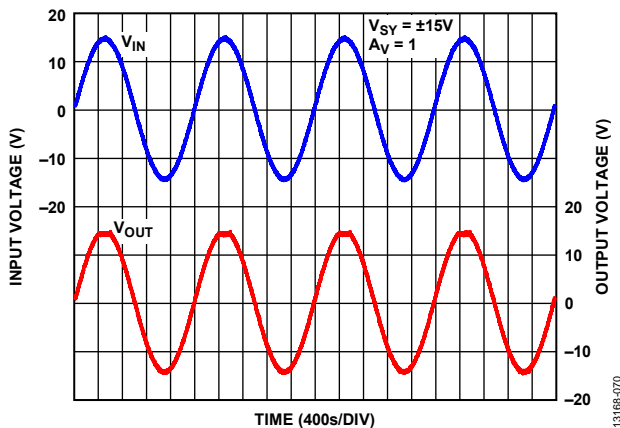

Figure 73. Input and Output Waveforms, No Phase Reversal

LARGE SIGNAL TRANSIENT RESPONSE

When the ADA4522-1/ADA4522-2/ADA4522-4 are configured in a closed-loop configuration with a large input transient (for example, a step input voltage), the internal back to back diodes may turn on. Consider a case where the amplifier is in unity-gain configuration with a step input waveform. This case is shown in Figure 74.

The noninverting input is driven by an input signal source and the inverting input is driven by the output of the amplifier. The maximum amplifier output current depends on the input step function and the external source resistance at the input terminals of the amplifier.

Case 1

If the external source resistance is low (for example, 100Ω in Figure 75) or if the input step function is large, the maximum amplifier output current is limited to the output short-circuit current as specified in the Specifications section. The maximum differential voltage between the input signal and the amplifier output is then limited by the maximum amplifier output current multiplied by the total input resistance (internal and external) and the turn-on voltage of the back to back diode (see Figure 72 for the input EMI filter and clamp circuit architecture).

When the noninverting input voltage changes with a step signal, the inverting input voltage (and, therefore, the output voltage) follows the change quickly until it reaches the maximum differen-

tial voltage between the input signal and amplifier output possible. The inverting input voltage then starts slewing with the slew rate specified in the Specifications section until it reaches its desired output. Therefore, as seen in Figure 74, there are two distinctive sections of the rising and falling edge of the output waveform. With this test condition, the amount and duration of the input/output current is limited and, therefore, does not damage the amplifier.

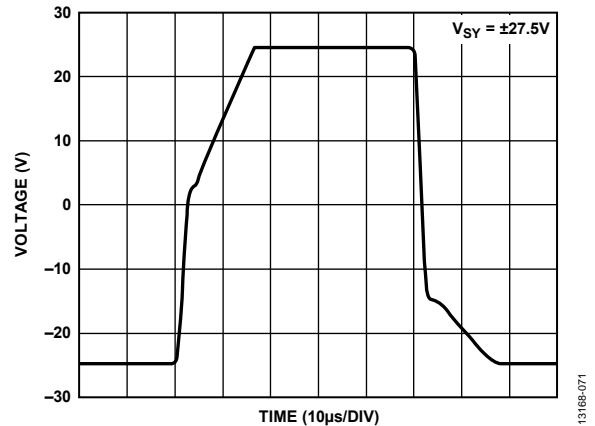

Figure 74. Large Signal Transient Response Example

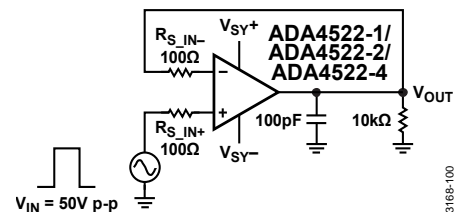

Figure 75. Circuit Diagram for Large Signal Transient Response

Case 2

If the external source resistance is high or if the input step function is small, the maximum output current is limited to the instantaneous difference between the input signal and amplifier output voltage (which is the change in the step function) divided by the source resistance. This maximum output current is less than the amplifier output short-circuit current. The maximum differential voltage between the input signal and the amplifier output is then equal to the step function. The output voltage slews until it reaches its desired output.

Therefore, if desired, reduce the input current by adding a larger external resistor between the signal source and the noninverting input. Similarly, to reduce output current, add an external resistor to the feedback loop between the inverting input and output. This large signal transient response issue is typically not a problem when the amplifier is configured in closed-loop gain, where the input signal source is usually much smaller and the gain and feedback resistors limit the current.

Back to back diodes are also implemented in many other amplifiers; these amplifiers show similar slewing behavior.

NOISE CONSIDERATIONS

1/f Noise

1/f noise, also known as pink noise or flicker noise, is inherent in semiconductor devices and increases as frequency decreases. At a low frequency, 1/f noise is a major noise contributor and causes a significant output voltage offset when amplified by the noise gain of the circuit. However, because the low frequency 1/f noise appears as a slow varying offset to the ADA4522-1/ADA4522-2/ADA4522-4, it is effectively reduced by the chopping technique. This technique allows the ADA4522-1/ADA4522-2/ADA4522-4 to have a much lower noise at dc and low frequency in comparison to standard low noise amplifiers that are susceptible to 1/f noise. Figure 64 shows the 0.1 Hz to 10 Hz noise to be only 117 nV p-p of noise.

Source Resistance

The ADA4522-1/ADA4522-2/ADA4522-4 are some of the lowest noise high voltage zero drift amplifiers with 5.8 nV/√Hz of voltage noise density at 1 kHz (A_v = 100). Therefore, it is important to consider the input source resistance of choice to maintain a total low noise. The total input referred broadband noise (e_{N total}) from any amplifier is primarily a function of three types of noise: input voltage noise, input current noise, and thermal (Johnson) noise from the external resistors.

These uncorrelated noise sources can be summed up in a root sum squared (rss) manner by using the following equation:

$$e_{N \text{ total}} = (e_N^2 + 4 kTR_S + (i_N \times R_S)^2)^{1/2}$$

where:

e_N is the input voltage noise density of the amplifier (V/√Hz).

k is Boltzmann's constant (1.38 × 10⁻²³ J/K).

T is the temperature in Kelvin (K).

R_S is the total input source resistance (Ω).

i_N is the input current noise density of the amplifier (A/√Hz).

The total equivalent rms noise over a specific bandwidth is expressed as

$$e_{N \text{ RMS}} = e_{N \text{ total}} \sqrt{BW}$$

where BW is the bandwidth in hertz.

This analysis is valid for broadband noise calculation up to a decade before the switching frequency. If the bandwidth of concern includes the switching frequency, more complicated calculations must be made to include the effect of the increase in noise at the switching frequency.

With a low source resistance of R_S < 1 kΩ, the voltage noise of the amplifier dominates. As the source resistance increases, the thermal noise of R_S dominates. As the source resistance further increases, where R_S > 50 kΩ, the current noise becomes the main contributor of the total input noise.

Residual Ripple

As shown in Figure 60, Figure 61, and Figure 62, the ADA4522-1/ADA4522-2/ADA4522-4 have a flat noise spectrum density at lower frequencies and exhibits spectrum density bumps and peaks at higher frequencies.

The largest noise bump is centered at 6 MHz; this bump is due to the decrease in the input gain at higher frequencies. This decrease is a typical phenomenon and can also be seen in other amplifiers. In addition to the noise bump, a sharp peak due to the chopping networks is seen at 4.8 MHz. However, this magnitude is significantly reduced by the offset and ripple correction loop. Its magnitude may be different with different amplifier units or with different circuitries around the amplifier. This peak can potentially be hidden by the noise bump and, therefore, may not be detected.

The offset and ripple correction loop, designed to reduce the 4.8 MHz switching artifact, also creates a noise bump centered at 800 kHz and a noise peak on top of this noise bump. Although the magnitude of the bump is mostly constant, the magnitude of the 800 kHz peak is different from unit to unit. Some units may not exhibit the 800 kHz noise peak; however, for other units, peaks occur at multiple integrals of 800 kHz, such as 1.6 MHz or 2.4 MHz.

These noise peaks, albeit small in magnitude, can be significant when the amplifier has a closed-loop frequency that is higher than the chopping frequency. To suppress the noise spike to a desired level, either configure the amplifier in a high gain configuration or apply a post filter at the output of the amplifier.

Figure 76 shows the voltage noise density of the ADA4522-1/ADA4522-2/ADA4522-4 in various gain configurations. Note that the higher the gain, the lower the available bandwidth is. The earlier bandwidth roll-off effectively filters out the higher noise spectrum.

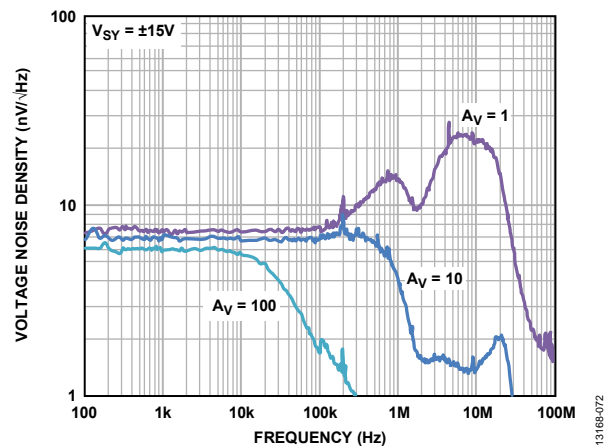

Figure 76. Voltage Noise Density with Various Gains

Figure 77 shows the voltage noise density of the ADA4522-1/ADA4522-2/ADA4522-4 without and with post filters at different frequencies. The post filter serves to roll off the bandwidth before the switching frequency. In this example, the noise peak at 800 kHz is about 38 nV/√Hz. With a post filter at 80 kHz, the noise peak is reduced to 4.1 nV/√Hz. With a post filter at 8 kHz, the noise peak is lower than the noise floor and cannot be detected.

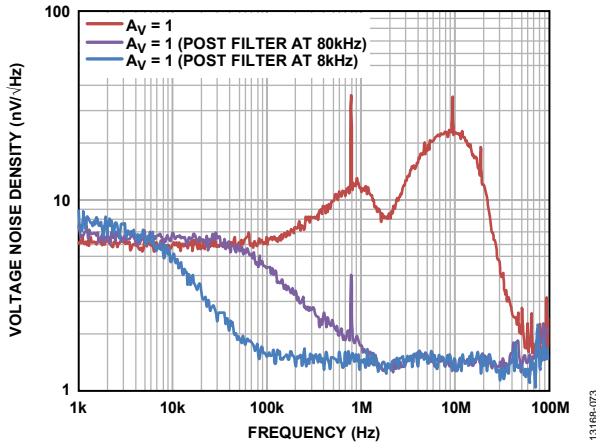

Figure 77. Voltage Noise Density with Post Filters

Current Noise Density

Figure 78 shows the current noise density of the ADA4522-1/ADA4522-2/ADA4522-4 at unity gain. At 1 kHz, the current noise density is about 1.3 pA/√Hz. The current noise density is determined by measuring the voltage noise due to current noise flowing through a resistor. Due to the low current noise density of the amplifier, the voltage noise is usually measured with a high value resistor; in this case, a 100 kΩ source resistor is used. However, the source resistor interacts with the input capacitance of the amplifier and board, causing the bandwidth to roll off. Note that Figure 78 shows the current noise density rolling off much earlier than the unity-gain bandwidth; this roll-off is expected.

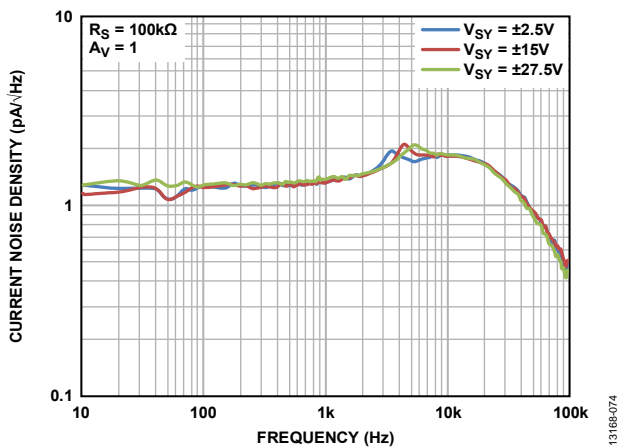

Figure 78. Current Noise Density at Gain = 1

EMI REJECTION RATIO

Circuit performance is often adversely affected by high frequency EMI. When the signal strength is low and transmission lines are long, an op amp must accurately amplify the input signals. However, all op amp pins—the noninverting input, inverting input, positive supply, negative supply, and output pins—are susceptible to EMI signals. These high frequency signals are coupled into an op amp by various means, such as conduction, near field radiation, or far field radiation. For example, wires and printed circuit board (PCB) traces can act as antennas and pick up high frequency EMI signals.

Amplifiers do not amplify EMI or RF signals due to their relatively low bandwidth. However, due to the nonlinearities of the input devices, op amps can rectify these out of band signals. When these high frequency signals are rectified, they appear as a dc offset at the output.

The ADA4522-1/ADA4522-2/ADA4522-4 have integrated EMI filters at their input stage. To describe the ability of the ADA4522-1/ADA4522-2/ADA4522-4 to perform as intended in the presence of electromagnetic energy, the electromagnetic interference rejection ratio (EMIRR) of the noninverting pin is specified in Table 2, Table 3, and Table 4 of the Specifications section. A mathematical method of measuring EMIRR is defined as follows:

$$EMIRR = 20\log(V_{IN_PEAK}/\Delta V_{OS})$$

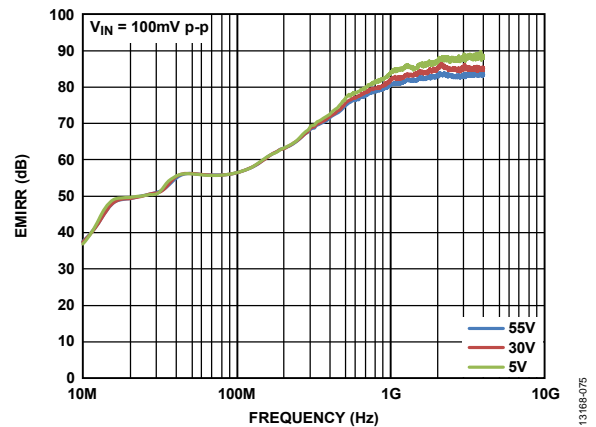

Figure 79. EMIRR vs. Frequency

CAPACITIVE LOAD STABILITY

The ADA4522-1/ADA4522-2/ADA4522-4 can safely drive capacitive loads of up to 250 pF in any configuration. As with most amplifiers, driving larger capacitive loads than specified may cause excessive overshoot and ringing, or even oscillation. A heavy capacitive load reduces the phase margin and causes the amplifier frequency response to peak. Peaking corresponds to overshooting or ringing in the time domain. Therefore, it is recommended that external compensation be used if the ADA4522-1/ADA4522-2/ADA4522-4 must drive a load exceeding 250 pF. This compensation is particularly important in the unity-gain configuration, which is the worst case for stability.

A quick and easy way to stabilize the op amp for capacitive load drive is by adding a series resistor, R_{ISO} , between the amplifier output terminal and the load capacitance, as shown in Figure 80. R_{ISO} isolates the amplifier output and feedback network from the capacitive load. However, with this compensation scheme, the output impedance as seen by the load increases, and this reduces gain accuracy.

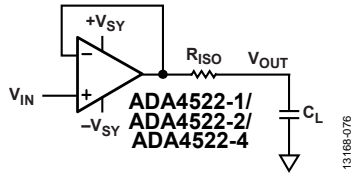

Figure 80. Stability Compensation with Isolating Resistor, R_{ISO}

Figure 81 shows the effect on overshoot with different values of R_{ISO} .

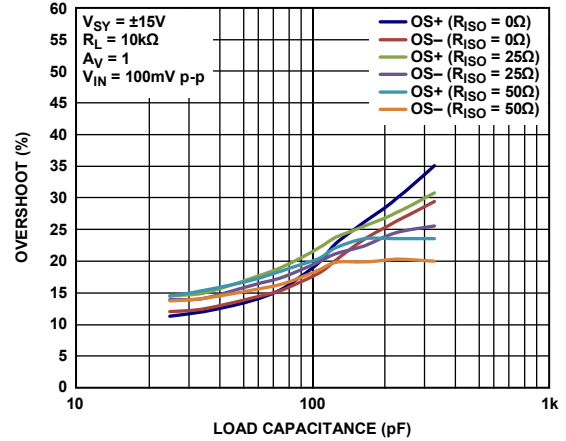

Figure 81. Small Signal Overshoot vs. Load Capacitance with Various Output Isolating Resistors

APPLICATIONS INFORMATION

SINGLE-SUPPLY INSTRUMENTATION AMPLIFIER

The extremely low offset voltage and drift, high open-loop gain, high common-mode rejection, and high power supply rejection of the [ADA4522-1/ADA4522-2/ADA4522-4](#) make them excellent op amp choices as discrete, single-supply instrumentation amplifiers.

Figure 82 shows the classic 3-op-amp instrumentation amplifier using the [ADA4522-1/ADA4522-2/ADA4522-4](#). The key to high CMRR for the instrumentation amplifier are resistors that are well matched for both the resistive ratio and relative drift. For true difference amplification, matching of the resistor ratio is very important, where $R5/R2 = R6/R4$. The resistors are important in determining the performance over manufacturing tolerances, time, and temperature. Assuming a perfect unity-gain difference amplifier with infinite common-mode rejection, a 1% tolerance resistor matching results in only 34 dB of common-mode rejection. Therefore, at least 0.01% or better resistors are recommended.

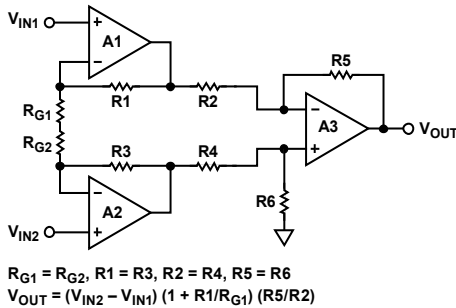

Figure 82. Discrete 3-Op-Amp Instrumentation Amplifier

To build a discrete instrumentation amplifier with external resistors without compromising on noise, pay close attention to the resistor values chosen. R_{G1} and R_{G2} each have thermal noise that is amplified by the total noise gain of the instrumentation amplifier and, therefore, a sufficiently low value must be chosen to reduce thermal noise contribution at the output while still providing an accurate measurement. Table 10 shows the external resistors noise contribution referred to the output (RTO).

Table 10. Thermal Noise Contribution Example

Resistor	Value (kΩ)	Resistor Thermal Noise (nV/√Hz)	Thermal Noise RTO (nV/√Hz)
R_{G1}	0.4	2.57	128.30
R_{G2}	0.4	2.57	128.30
R1	10	12.83	25.66
R2	10	12.83	25.66
R3	10	12.83	25.66
R4	10	12.83	25.66
R5	20	18.14	18.14
R6	20	18.14	18.14

Note that A1 and A2 have a high gain of $1 + R1/R_{G1}$. Therefore, use a high precision, low offset voltage and low noise amplifier for A1 and A2, such as the [ADA4522-1/ADA4522-2/ADA4522-4](#). Conversely, A3 operates at a much lower gain and has a differ-

ent set of op amp requirements. Its input noise, referred to the overall instrumentation amplifier input, is divided by the first stage gain and is not as important. Note that the input offset voltage and the input voltage noise of the amplifiers are also amplified by the overall noise gain.

Any unused channel of the [ADA4522-1/ADA4522-2/ADA4522-4](#) must be configured in unity gain with the input common-mode voltage tied to the midpoint of the power supplies.

Understanding how noise impacts a discrete instrumentation amplifier or a difference amplifier (the second stage of a 3-op-amp instrumentation amplifier) is important, because they are commonly used in many different applications. The Load Cell/Strain Gage Sensor Signal Conditioning section and the Precision Low-Side Current Shunt Sensor section show the [ADA4522-1/ADA4522-2/ADA4522-4](#) used as a discrete instrumentation or difference amplifier in an application.

LOAD CELL/STRAIN GAGE SENSOR SIGNAL CONDITIONING USING THE ADA4522-2

The [ADA4522-2](#), with its ultralow offset, drift, and noise, is well suited to signal condition a low level sensor output with high gain and accuracy. A weigh scale/load cell is an example of an application with such requirements. Figure 83 shows a configuration for a single-supply, precision, weigh scale measurement system. The [ADA4522-2](#) is used at the front end for amplification of the low level signal from the load cell.

Current flowing through a PCB trace produces an IR voltage drop; with longer traces, this voltage drop can be several millivolts or more, introducing a considerable error. A 1 inch long, 0.005 inch wide trace of 1 oz copper has a resistance of approximately 100 mΩ at room temperature. With a load current of 10 mA, the resistance can introduce a 1 mV error.

Therefore, a 6-wire load cell is used in the circuit. The load cell has two sense pins, in addition to excitation, ground, and two output connections. The sense pins are connected to the high side (excitation pin) and low side (ground pin) of the Wheatstone bridge. The voltage across the bridge can then be accurately measured regardless of voltage drop due to wire resistance. The two sense pins are also connected to the analog-to-digital converter (ADC) reference inputs for a ratiometric configuration that is immune to low frequency changes in the power supply excitation voltage.

The [ADA4522-2](#) is configured as the first stage of a 3-op-amp instrumentation amplifier to amplify the low level amplitude signal from the load cell by a factor of $1 + 2R1/R_G$. Capacitors C1 and C2 are placed in the feedback loops of the amplifiers and interact with R1 and R2 to perform low-pass filtering. This filtering limits the amount of noise entering the Σ - Δ ADC. In addition, C3, C4, C5, R3, and R4 provide further common-mode and differential mode filtering to reduce noise and unwanted signals.

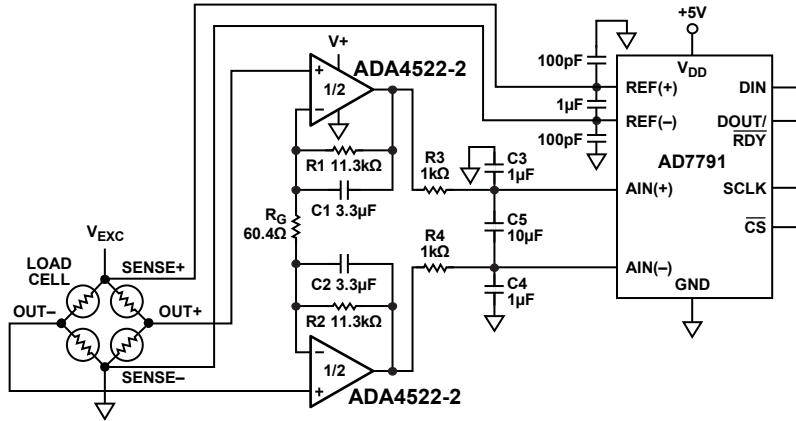

Figure 83. Precision Weigh Scale Measurement System

PRECISION LOW-SIDE CURRENT SHUNT SENSOR

Many applications require the sensing of signals near the positive or negative rails. Current shunt sensors are one such application and are mostly used for feedback control systems. They are also used in a variety of other applications, including power metering, battery fuel gauging, and feedback controls in industrial applications. In such applications, it is desirable to use a shunt with very low resistance to minimize series voltage drop. This configuration not only minimizes wasted power, but also allows the measurement of high currents while saving power.

A typical shunt may be 100 mΩ. At a measured current of 1 A, the voltage produced from the shunt is 100 mV, and the amplifier error sources are not critical. However, at low measured current in the 1 mA range, the 100 μV generated across the shunt demands a very low offset voltage and drift amplifier to maintain absolute accuracy. The unique attributes of a zero drift amplifier provide a solution. Figure 84 shows a low-side current sensing circuit using the ADA4522-1/ADA4522-2/ADA4522-4. The ADA4522-1/ADA4522-2/ADA4522-4 are configured as difference amplifiers with a gain of 1000. Although the ADA4522-1/ADA4522-2/ADA4522-4 have high CMRR, the CMRR of the system is limited by the external resistors. Therefore, as mentioned in the Single-Supply Instrumentation Amplifier section, the key to high CMRR for the system is resistors that are well matched from both the resistive ratio and relative drift, where R1/R2 = R3/R4.

Any unused channel of the ADA4522-1/ADA4522-2/ADA4522-4 must be configured in unity gain with the input common-mode voltage tied to the midpoint of the power supplies.

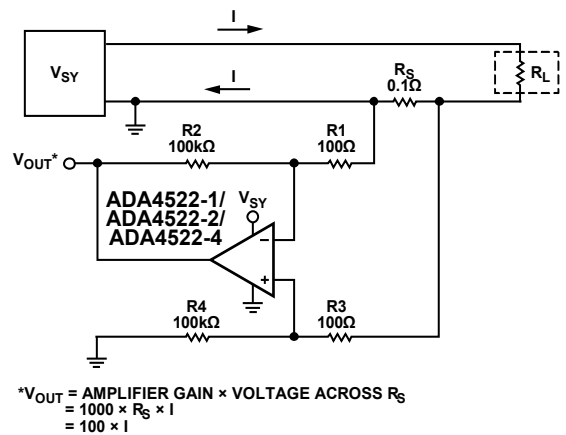

Figure 84. Low-Side Current Sensing Circuit

PRINTED CIRCUIT BOARD LAYOUT

The ADA4522-1/ADA4522-2/ADA4522-4 are high precision devices with ultralow offset voltage and noise. Therefore, take care in the design of the PCB layout to achieve optimum performance of the ADA4522-1/ADA4522-2/ADA4522-4 at the board level.

To avoid leakage currents, keep the surface of the board clean and free of moisture.

Properly bypassing the power supplies and keeping the supply traces short minimizes power supply disturbances caused by output current variation. Connect bypass capacitors as close as possible to the device supply pins. Stray capacitances are a concern at the outputs and the inputs of the amplifier. It is recommended that signal traces be kept at a distance of at least 5 mm from supply lines to minimize coupling.

A potential source of offset error is the Seebeck voltage on the circuit board. The Seebeck voltage occurs at the junction of two dissimilar metals and is a function of the temperature of the junction. The most common metallic junctions on a circuit board are solder to board traces and solder to component leads. Figure 85 shows a cross section of a surface-mount component soldered to a PCB. A variation in temperature across the board (where T_{A1} ≠ T_{A2}) causes a mismatch in the Seebeck voltages at the solder joints, thereby resulting in thermal voltage errors that degrade the

performance of the ultralow offset voltage of the [ADA4522-1/ADA4522-2/ADA4522-4](#).

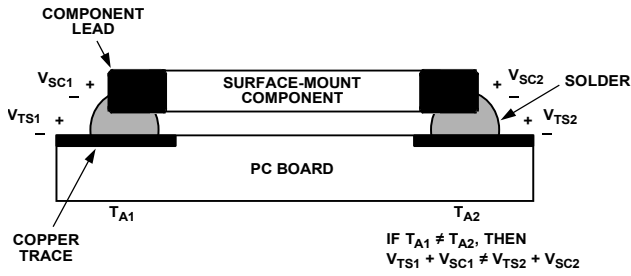

Figure 85. Mismatch in Seebeck Voltages Causes Seebeck Voltage Error

In Figure 85, V_{SC1} and V_{SC2} are the Seebeck voltages due to solder to component at Junction 1 and Junction 2, respectively. V_{TS1} and V_{TS2} are the Seebeck voltages due to solder to trace at Junction 1 and Junction 2. T_{A1} and T_{A2} are the temperatures of Junction 1 and Junction 2, respectively.

To minimize these thermocouple effects, orient resistors so that heat sources warm both ends equally. Where possible, it is recommended that the input signal paths contain matching numbers and types of components to match the number and type of thermocouple junctions. For example, dummy components, such as zero value resistors, can be used to match the thermoelectric error source (real resistors in the opposite input path). Place matching components in close proximity and orient them in the same manner to ensure equal Seebeck voltages, thus cancelling thermal errors. Additionally, use leads that are of equal length to keep thermal conduction in equilibrium. Keep heat sources on the PCB as far away from amplifier input circuitry as is practical.

It is highly recommended to use a ground plane. A ground plane helps distribute heat throughout the board, maintain a constant temperature across the board, and reduce EMI noise pickup.

COMPARATOR OPERATION

An op amp is designed to operate in a closed-loop configuration with feedback from its output to its inverting input. In contrast to op amps, comparators are designed to operate in an open-loop configuration and to drive logic circuits. Although op amps are different from comparators, occasionally an unused section of a dual op amp is used as a comparator to save board space and cost; however, this is not recommended for the [ADA4522-1/ADA4522-2/ADA4522-4](#).

Figure 86 and Figure 87 show the [ADA4522-1/ADA4522-2/ADA4522-4](#) configured as a comparator, with 10 kΩ resistors in series with the input pins. Any unused channels are configured as buffers with the input voltage kept at the midpoint of the power supplies. The [ADA4522-1/ADA4522-2/ADA4522-4](#) have input devices that are protected from large differential input voltages by Diode D5 and Diode D6, as shown in Figure 72. These diodes consist of substrate PNP bipolar transistors, and conduct whenever the differential input voltage exceeds approximately 600 mV; however, these diodes also allow a current path from the input

to the lower supply rail, resulting in an increase in the total supply current of the system. Both comparator configurations yield the same result. At 30 V of power supply, I_{SY+} remains at 1.55 mA per dual amplifier, but I_{SY-} increases close to 2 mA in magnitude per dual amplifier.

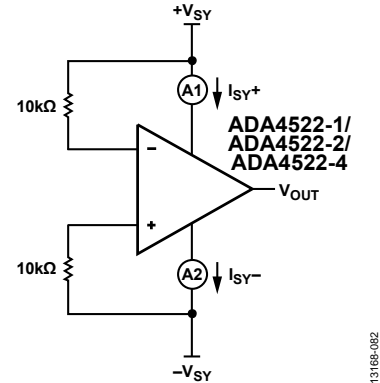

Figure 86. Comparator Configuration A

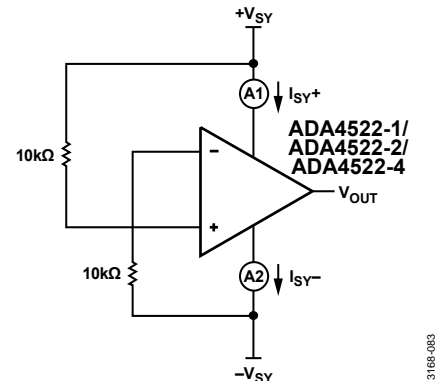

Figure 87. Comparator Configuration B

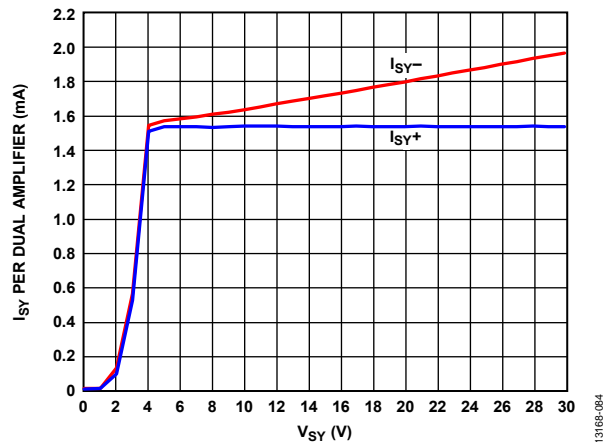

Figure 88. Supply Current (I_{SY}) per Dual Amplifier vs. Supply Voltage (V_{SY}) ([ADA4522-1/ADA4522-2/ADA4522-4](#) as a Comparator)

Note that 10 kΩ resistors are used in series with the input of the op amp. If smaller resistor values are used, the supply current of the system increases much more. For more details on op amps as comparators, see the [AN-849 Application Note, Using Op Amps as Comparators](#).

USE OF LARGE SOURCE RESISTANCE

The ADA4522-1/ADA4522-2/ADA4522-4 are designed to work with low value source resistance. Note that the amplifier has an ultralow voltage noise density of 6 nV/√Hz. A 1 kΩ resistor contributes 4 nV/√Hz; therefore, placing a 1 kΩ resistor at the input increases total noise to 7.2 nV/√Hz. For this noise reason, it is recommended to avoid using large source resistance.

Unity Gain Follower with Large Source Resistance

When the ADA4522-1/ADA4522-2/ADA4522-4 are configured in a unity-gain follower configuration with a large source resistance and slow power supply ramp rate, the amplifier output may rail to the positive supply.

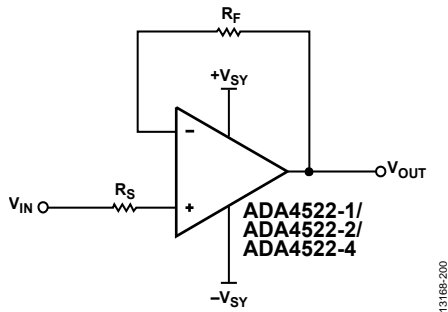

Figure 89. Insert R_F When Large R_S is Used

Workaround

To avoid the amplifier output railing to the positive supply, implement one of the following actions (see Table 11 and Figure 89):

- Reduce the value of the source resistance (R_S).
- Insert a feedback resistor (R_F).

Table 11. Amplifier Output Railing Workaround Recommendations

Condition	Recommendation
$1.5\text{ V} \leq V_{SY} - V_{IN} < 2.5\text{ V}$	$R_F = 200\ \Omega$ or $R_F \geq 50 R_S$, whichever is greater
$2.5\text{ V} \leq V_{SY} - V_{IN} < 3.5\text{ V}$	$R_S \leq 200\ \Omega$ or $R_F \geq 2 R_S$
$V_{SY} - V_{IN} \geq 3.5\text{ V}$	$R_S \leq 500\ \Omega$ or $R_F \geq 0.5 R_S$

OUTLINE DIMENSIONS

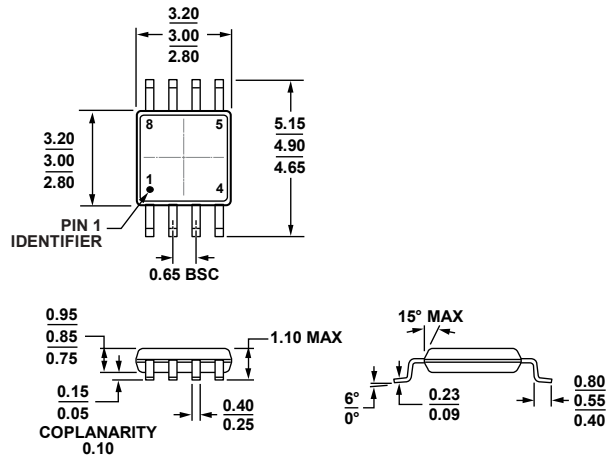

COMPLIANT TO JEDEC STANDARDS MO-187-AA

Figure 90. 8-Lead Mini Small Outline Package [MSOP] (RM-8)

Dimensions shown in millimeters

10-07-2009-B

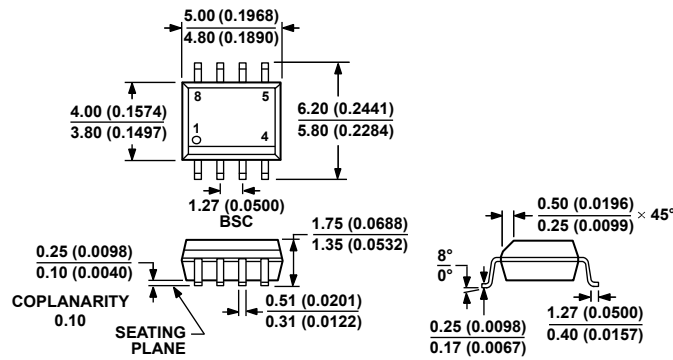

COMPLIANT TO JEDEC STANDARDS MS-012-AA

CONTROLLING DIMENSIONS ARE IN MILLIMETERS; INCH DIMENSIONS (IN PARENTHESES) ARE ROUNDED-OFF MILLIMETER EQUIVALENTS FOR REFERENCE ONLY AND ARE NOT APPROPRIATE FOR USE IN DESIGN.

Figure 91. 8-Lead Small Outline Package [SOIC_N] Narrow Body (R-8)

Dimensions shown in millimeters and (inches)

0 12 407-A

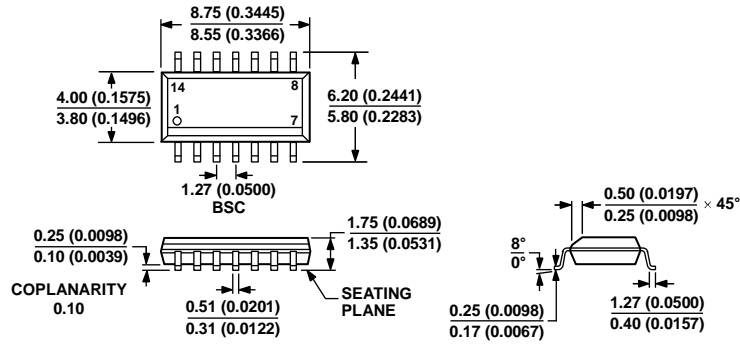

COMPLIANT TO JEDEC STANDARDS MS-012-AB
 CONTROLLING DIMENSIONS ARE IN MILLIMETERS; INCH DIMENSIONS
 (IN PARENTHESES) ARE ROUNDED-OFF MILLIMETER EQUIVALENTS FOR
 REFERENCE ONLY AND ARE NOT APPROPRIATE FOR USE IN DESIGN.

Figure 92. 14-Lead Small Outline Package [SOIC_N]
 Narrow Body
 (R-14)
 Dimensions shown in millimeters and (inches)

060606-A

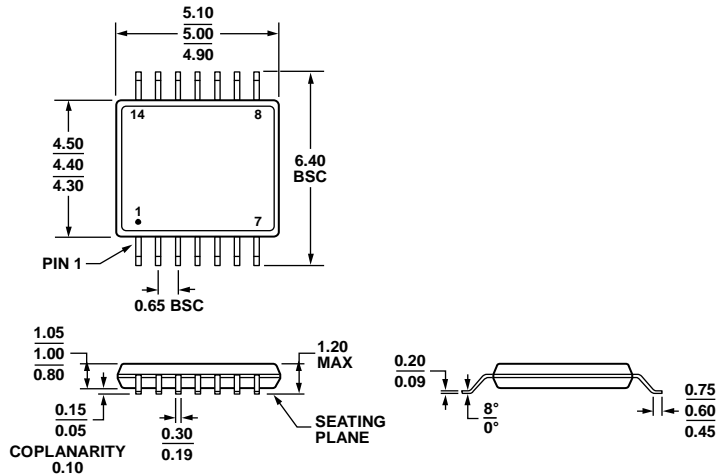

COMPLIANT TO JEDEC STANDARDS MO-153-AB-1
 Figure 93. 14-Lead Thin Shrink Small Outline Package [TSSOP]
 (RU-14)
 Dimensions shown in millimeters

051906-A

ORDERING GUIDE

Model ¹	Temperature Range	Package Description	Package Option	Branding
ADA4522-1ARMZ	-40°C to +125°C	8-Lead Mini Small Outline Package [MSOP]	RM-8	A3G
ADA4522-1ARMZ-R7	-40°C to +125°C	8-Lead Mini Small Outline Package [MSOP]	RM-8	A3G
ADA4522-1ARMZ-RL	-40°C to +125°C	8-Lead Mini Small Outline Package [MSOP]	RM-8	A3G
ADA4522-1ARZ	-40°C to +125°C	8-Lead Small Outline Package [SOIC_N]	R-8	
ADA4522-1ARZ-R7	-40°C to +125°C	8-Lead Small Outline Package [SOIC_N]	R-8	
ADA4522-1ARZ-RL	-40°C to +125°C	8-Lead Small Outline Package [SOIC_N]	R-8	
ADA4522-2ARMZ	-40°C to +125°C	8-Lead Mini Small Outline Package [MSOP]	RM-8	A39
ADA4522-2ARMZ-R7	-40°C to +125°C	8-Lead Mini Small Outline Package [MSOP]	RM-8	A39
ADA4522-2ARMZ-RL	-40°C to +125°C	8-Lead Mini Small Outline Package [MSOP]	RM-8	A39
ADA4522-2ARZ	-40°C to +125°C	8-Lead Small Outline Package [SOIC_N]	R-8	
ADA4522-2ARZ-R7	-40°C to +125°C	8-Lead Small Outline Package [SOIC_N]	R-8	
ADA4522-2ARZ-RL	-40°C to +125°C	8-Lead Small Outline Package [SOIC_N]	R-8	
ADA4522-4ARUZ	-40°C to +125°C	14-Lead Thin Shrink Small Outline Package [TSSOP]	RU-14	
ADA4522-4ARUZ-R7	-40°C to +125°C	14-Lead Thin Shrink Small Outline Package [TSSOP]	RU-14	
ADA4522-4ARUZ-RL	-40°C to +125°C	14-Lead Thin Shrink Small Outline Package [TSSOP]	RU-14	
ADA4522-4ARZ	-40°C to +125°C	14-Lead Standard Small Outline Package [SOIC_N]	R-14	
ADA4522-4ARZ-R7	-40°C to +125°C	14-Lead Standard Small Outline Package [SOIC_N]	R-14	
ADA4522-4ARZ-RL	-40°C to +125°C	14-Lead Standard Small Outline Package [SOIC_N]	R-14	

¹ Z = RoHS Compliant Part.

Mouser Electronics

Authorized Distributor

Click to View Pricing, Inventory, Delivery & Lifecycle Information:

[Analog Devices Inc.:](#)

[ADA4522-2ARMZ](#) [ADA4522-2ARZ-R7](#) [ADA4522-2ARMZ-RL](#) [ADA4522-2ARMZ-R7](#) [ADA4522-2ARZ-RL](#) [ADA4522-2ARZ](#) [ADA4522-4ARUZ-R7](#) [ADA4522-4ARZ-RL](#) [ADA4522-4ARZ](#) [ADA4522-4ARUZ](#) [ADA4522-4ARZ-R7](#) [ADA4522-4ARUZ-RL](#) [ADA4522-1ARZ](#) [ADA4522-1ARMZ](#) [ADA4522-1ARZ-RL](#) [ADA4522-1ARZ-R7](#) [ADA4522-1ARMZ-R7](#) [ADA4522-1ARMZ-RL](#)