

Click to view price, real time Inventory,
Delivery & Lifecycle Information ;

STD12NF06LT4

STMicroelectronics

MOSFET N-Ch 60 Volt 12 Amp

Any questions, please feel free to contact us.
info@kaimte.com

N-channel 60 V, 70 mΩ typ., 12 A, StripFET™ II Power MOSFET in a DPAK package

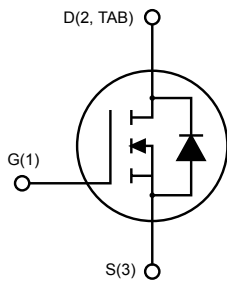
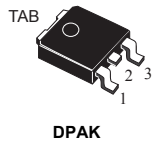

AM01475v1_noZen

Features

Order code	V _{DS}	R _{DS(on)} max.	I _D
STD12NF06LT4	60 V	90 mΩ	12 A

- Exceptional dv/dt capability
- 100% avalanche tested
- Low gate charge

Applications

- Switching applications

Description

This Power MOSFET series has been developed using STMicroelectronics' unique STripFET™ process, which is specifically designed to minimize input capacitance and gate charge. This renders the device suitable for use as primary switch in advanced high-efficiency isolated DC-DC converters for telecom and computer applications, and applications with low gate charge driving requirements.

Product status link

[STD12NF06LT4](#)

Product summary

Order code	STD12NF06LT4
Marking	D12NF06L
Package	DPAK
Packing	Tape and reel

1 Electrical ratings

Table 1. Absolute maximum ratings

Symbol	Parameter	Value	Unit
V_{DS}	Drain-source voltage	60	V
V_{GS}	Gate-source voltage	±16	V
I_D	Drain current (continuous) at $T_{case} = 25\text{ °C}$	12	A
	Drain current (continuous) at $T_{case} = 100\text{ °C}$	8.5	
$I_{DM}^{(1)}$	Drain current (pulsed)	48	A
P_{TOT}	Total dissipation at $T_{case} = 25\text{ °C}$	30	W
$dv/dt^{(2)}$	Peak diode recovery voltage slope	15	V/ns
$E_{AS}^{(3)}$	Single pulse avalanche energy	100	mJ
T_{stg}	Storage temperature range	-55 to 175	°C
T_J	Operating junction temperature range		

1. Pulse width is limited by safe operating area.
2. $I_{SD} \leq 12\text{ A}$, $di/dt \leq 200\text{ A}/\mu\text{s}$, $V_{DS} \leq 40\text{ V}$, $T_J \leq T_{JMAX}$
3. Starting $T_J = 25\text{ °C}$, $I_D = 6\text{ A}$, $V_{DD} = 30\text{ V}$

Table 2. Thermal data

Symbol	Parameter	Value	Unit
$R_{thj-case}$	Thermal resistance junction-case	5	°C/W
$R_{thj-pcb}^{(1)}$	Thermal resistance junction-pcb	50	

1. When mounted on a 1-inch² FR-4, 2 Oz copper board.

2 Electrical characteristics

($T_{\text{case}} = 25\text{ }^{\circ}\text{C}$ unless otherwise specified)

Table 3. On/off states

Symbol	Parameter	Test conditions	Min.	Typ.	Max.	Unit
$V_{(\text{BR})\text{DSS}}$	Drain-source breakdown voltage	$V_{\text{GS}} = 0\text{ V}$, $I_{\text{D}} = 250\text{ }\mu\text{A}$	60			V
I_{DSS}	Zero gate voltage drain current	$V_{\text{GS}} = 0\text{ V}$, $V_{\text{DS}} = 60\text{ V}$			1	μA
		$V_{\text{GS}} = 0\text{ V}$, $V_{\text{DS}} = 60\text{ V}$, $T_{\text{case}} = 125\text{ }^{\circ}\text{C}^{(1)}$			10	
I_{GSS}	Gate-body leakage current	$V_{\text{DS}} = 0\text{ V}$, $V_{\text{GS}} = \pm 16\text{ V}$			± 100	nA
$V_{\text{GS(th)}}$	Gate threshold voltage	$V_{\text{DS}} = V_{\text{GS}}$, $I_{\text{D}} = 250\text{ }\mu\text{A}$	1		2	V
$R_{\text{DS(on)}}$	Static drain-source on-resistance	$V_{\text{GS}} = 10\text{ V}$, $I_{\text{D}} = 6\text{ A}$		70	90	m Ω
		$V_{\text{GS}} = 5\text{ V}$, $I_{\text{D}} = 6\text{ A}$		80	100	

1. Defined by design, not subject to production test.

Table 4. Dynamic

Symbol	Parameter	Test conditions	Min.	Typ.	Max.	Unit
C_{iss}	Input capacitance	$V_{\text{DS}} = 25\text{ V}$, $f = 1\text{ MHz}$, $V_{\text{GS}} = 0\text{ V}$	-	350		μF
C_{oss}	Output capacitance		-	75		
C_{riss}	Reverse transfer capacitance		-	30		
Q_{g}	Total gate charge	$V_{\text{DD}} = 48\text{ V}$, $I_{\text{D}} = 12\text{ A}$,	-	7.5	10	nC
Q_{gs}	Gate-source charge	$V_{\text{GS}} = 0\text{ to }5\text{ V}$	-	2.5		
Q_{gd}	Gate-drain charge	(see Figure 13. Test circuit for gate charge behavior)	-	3.0		

Table 5. Switching times

Symbol	Parameter	Test conditions	Min.	Typ.	Max.	Unit
$t_{\text{d(on)}}$	Turn-on delay time	$V_{\text{DD}} = 30\text{ V}$, $I_{\text{D}} = 6\text{ A}$, $R_{\text{G}} = 4.7\text{ }\Omega$, $V_{\text{GS}} = 4.5\text{ V}$	-	10	-	ns
t_{r}	Rise time		-	35	-	
$t_{\text{d(off)}}$	Turn-off delay time	(see Figure 12. Test circuit for resistive load switching times and Figure 17. Switching time waveform)	-	20	-	
t_{f}	Fall time		-	13	-	

Table 6. Source-drain diode

Symbol	Parameter	Test conditions	Min.	Typ.	Max.	Unit
I_{SD}	Source-drain current		-		12	A
$I_{\text{SDM}}^{(1)}$	Source-drain current (pulsed)		-		48	A

Symbol	Parameter	Test conditions	Min.	Typ.	Max.	Unit
$V_{SD}^{(2)}$	Forward on voltage	$V_{GS} = 0\text{ V}$, $I_{SD} = 12\text{ A}$	-		1.5	V
t_{rr}	Reverse recovery time	$I_{SD} = 12\text{ A}$, $di/dt = 100\text{ A}/\mu\text{s}$, $V_{DD} = 16\text{ V}$, $T_J = 150\text{ }^\circ\text{C}$ (see Figure 14. Test circuit for inductive load switching and diode recovery times)	-	50		ns
Q_{rr}	Reverse recovery charge		-	65		nC
I_{RRM}	Reverse recovery current		-	2.5		A

1. Pulse width limited by safe operating area.
2. Pulsed: pulse duration = 300 μs , duty cycle 1.5%.

2.1 Electrical characteristics (curves)

Figure 1. Safe operating area

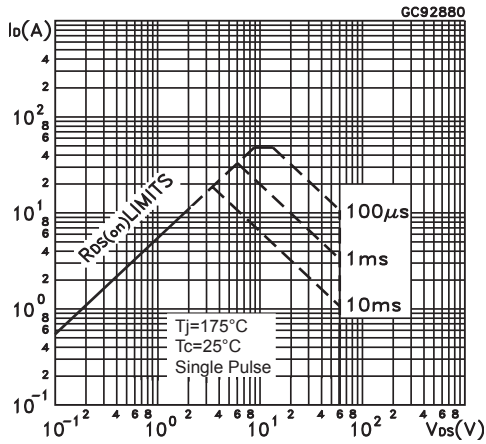

Figure 2. Thermal impedance

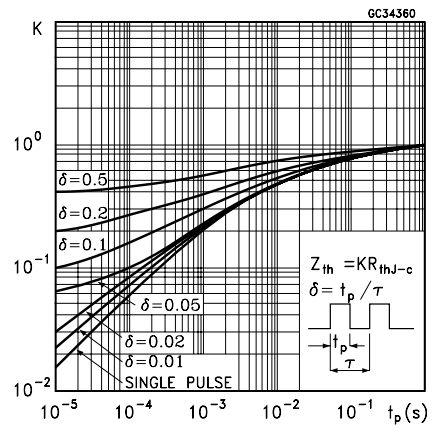

Figure 3. Output characteristics

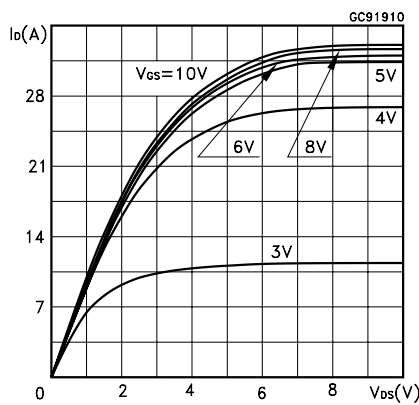

Figure 4. Transfer characteristics

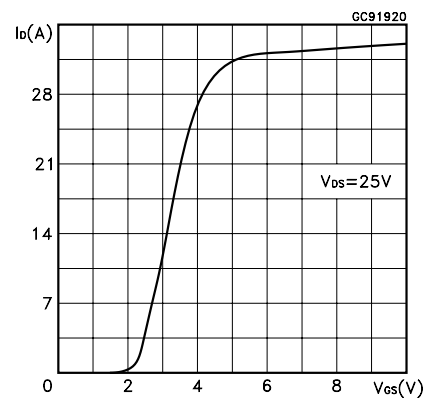

Figure 5. Normalized $V_{(BR)DSS}$ vs temperature

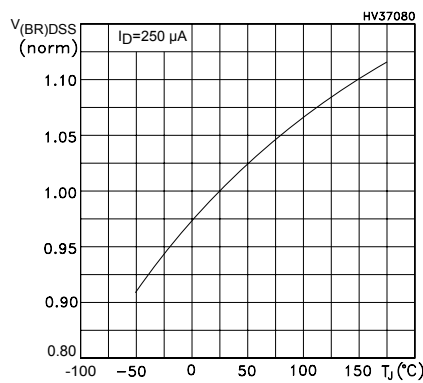

Figure 6. Static drain-source on-resistance

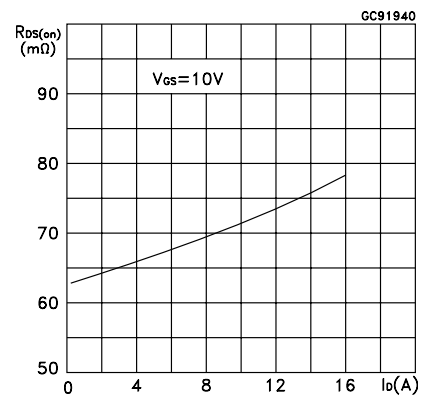

Figure 7. Gate charge vs gate-source voltage

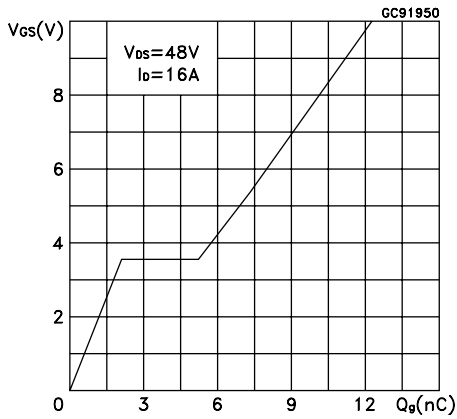

Figure 8. Capacitance variations

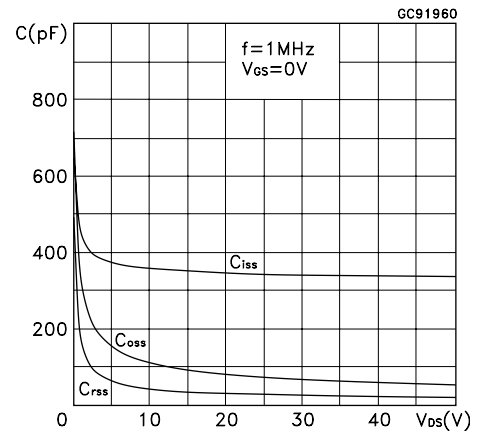

Figure 9. Normalized gate threshold vs temperature

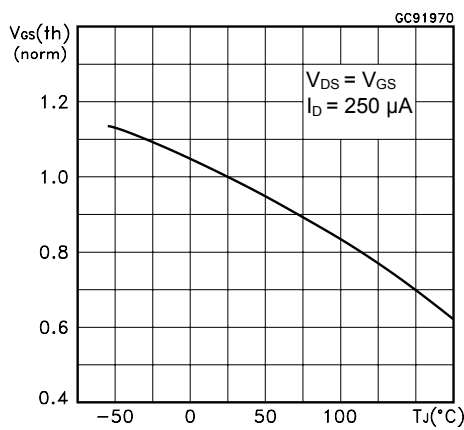

Figure 10. Normalized on-resistance vs temperature

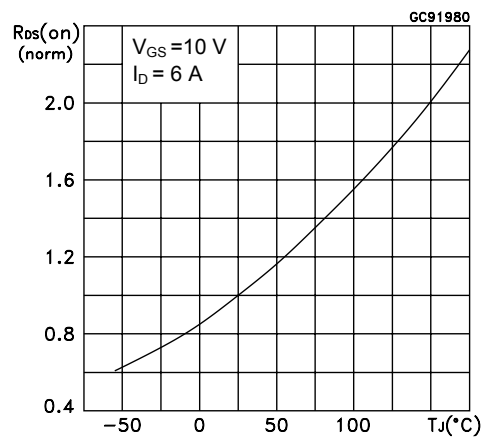
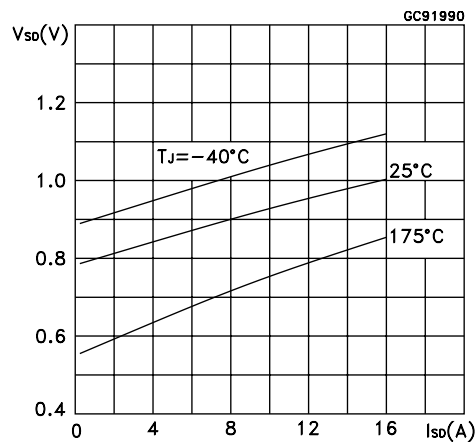
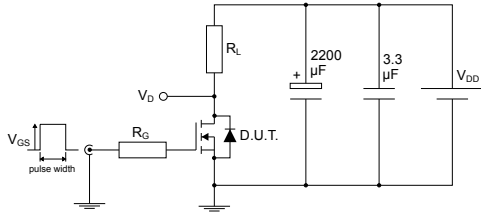

Figure 11. Source-drain diode forward characteristics



3 Test circuits

Figure 12. Test circuit for resistive load switching times

AM01468v1

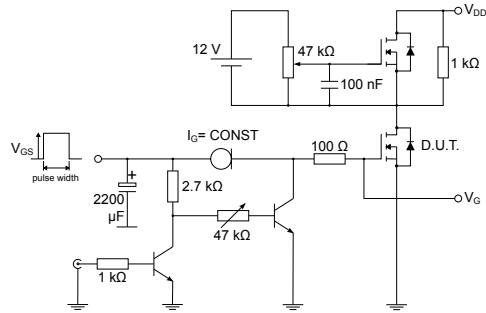
Figure 13. Test circuit for gate charge behavior

AM01469v1

Figure 14. Test circuit for inductive load switching and diode recovery times

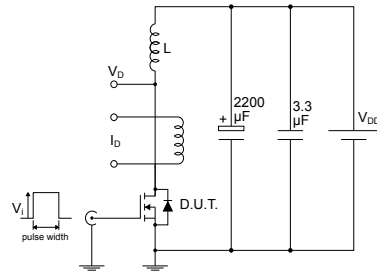

AM01470v1

Figure 15. Unclamped inductive load test circuit

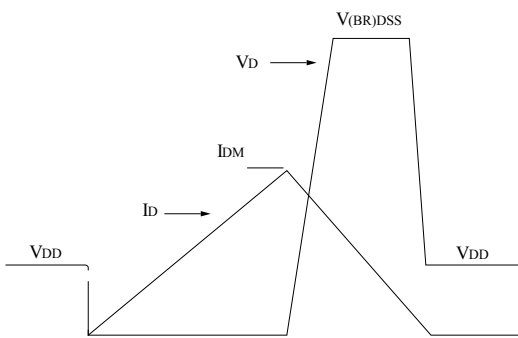
AM01471v1

Figure 16. Unclamped inductive waveform

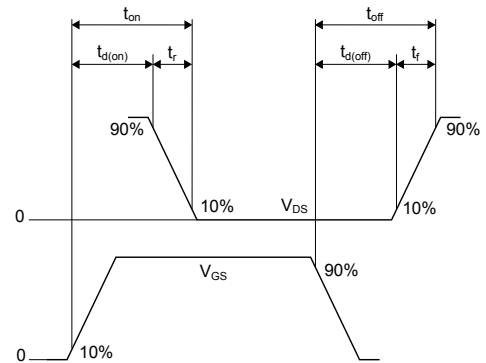
AM01472v1

Figure 17. Switching time waveform

AM01473v1

4 Package information

In order to meet environmental requirements, ST offers these devices in different grades of ECOPACK® packages, depending on their level of environmental compliance. ECOPACK® specifications, grade definitions and product status are available at: www.st.com. ECOPACK® is an ST trademark.

4.1 DPAK (TO-252) type A package information

Figure 18. DPAK (TO-252) type A package outline

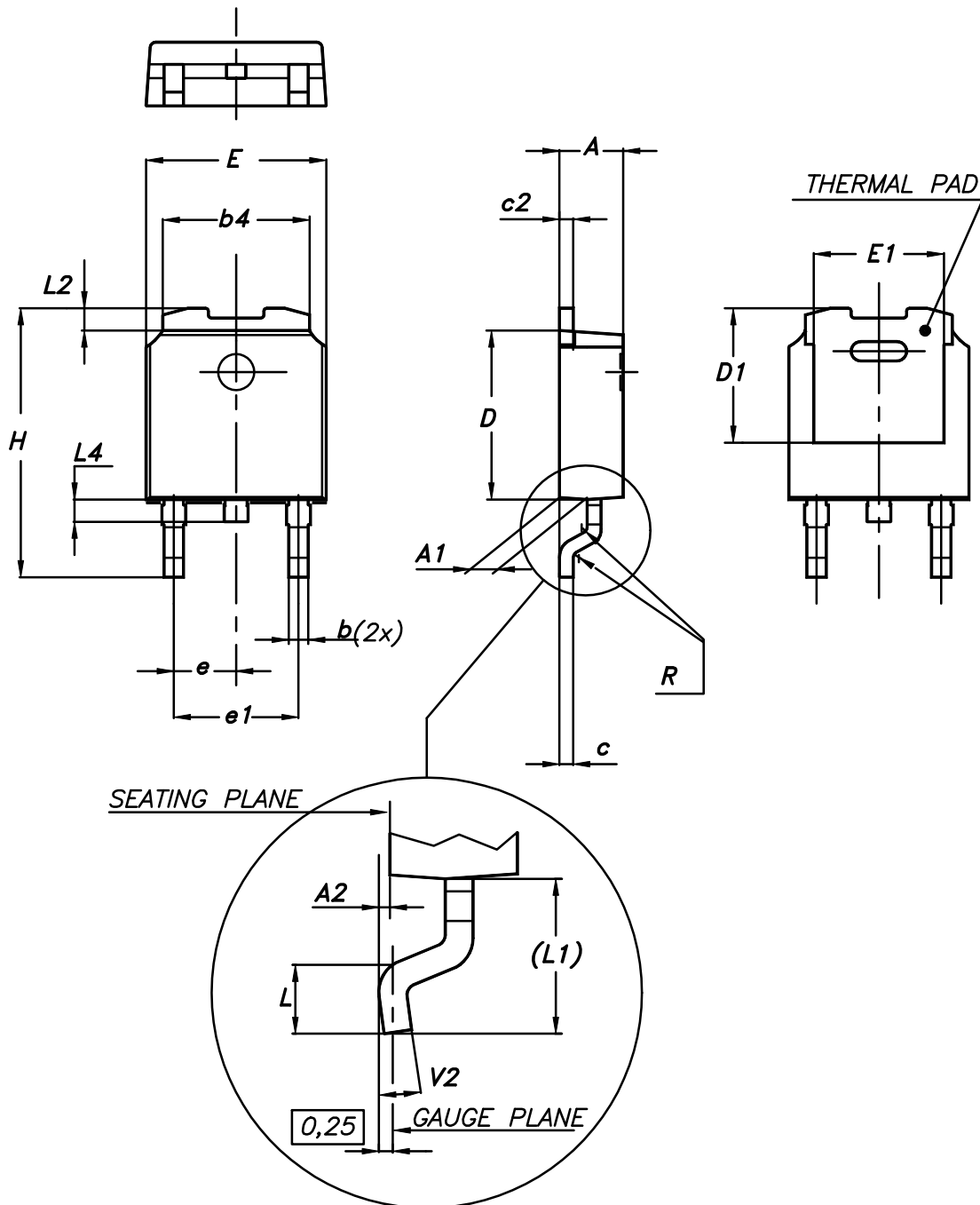

0068772_A_25

Table 7. DPAK (TO-252) type A mechanical data

Dim.	mm		
	Min.	Typ.	Max.
A	2.20		2.40
A1	0.90		1.10
A2	0.03		0.23
b	0.64		0.90
b4	5.20		5.40
c	0.45		0.60
c2	0.48		0.60
D	6.00		6.20
D1	4.95	5.10	5.25
E	6.40		6.60
E1	4.60	4.70	4.80
e	2.159	2.286	2.413
e1	4.445	4.572	4.699
H	9.35		10.10
L	1.00		1.50
(L1)	2.60	2.80	3.00
L2	0.65	0.80	0.95
L4	0.60		1.00
R		0.20	
V2	0°		8°

4.2 DPAK (TO-252) type C package information

Figure 19. DPAK (TO-252) type C package outline

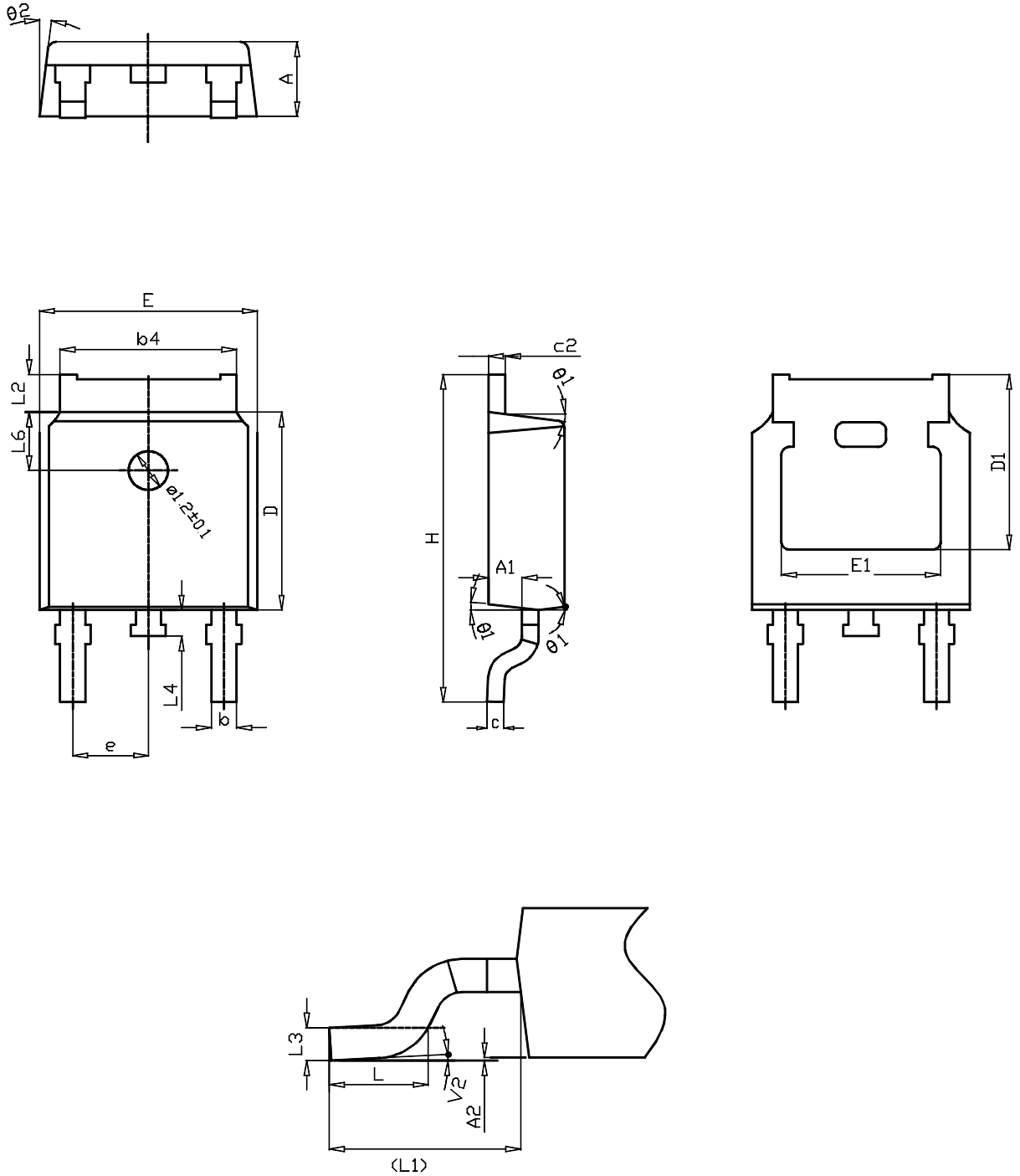

0068772_C_25

Table 8. DPAK (TO-252) type C mechanical data

Dim.	mm		
	Min.	Typ.	Max.
A	2.20	2.30	2.38
A1	0.90	1.01	1.10
A2	0.00		0.10
b	0.72		0.85
b4	5.13	5.33	5.46
c	0.47		0.60
c2	0.47		0.60
D	6.00	6.10	6.20
D1	5.25		
E	6.50	6.60	6.70
E1	4.70		
e	2.186	2.286	2.386
H	9.80	10.10	10.40
L	1.40	1.50	1.70
L1	2.90 REF		
L2	0.90		1.25
L3	0.51 BSC		
L4	0.60	0.80	1.00
L6	1.80 BSC		
θ1	5°	7°	9°
θ2	5°	7°	9°
V2	0°		8°

4.3 DPAK (TO-252) type E package information

Figure 20. DPAK (TO-252) type E package outline

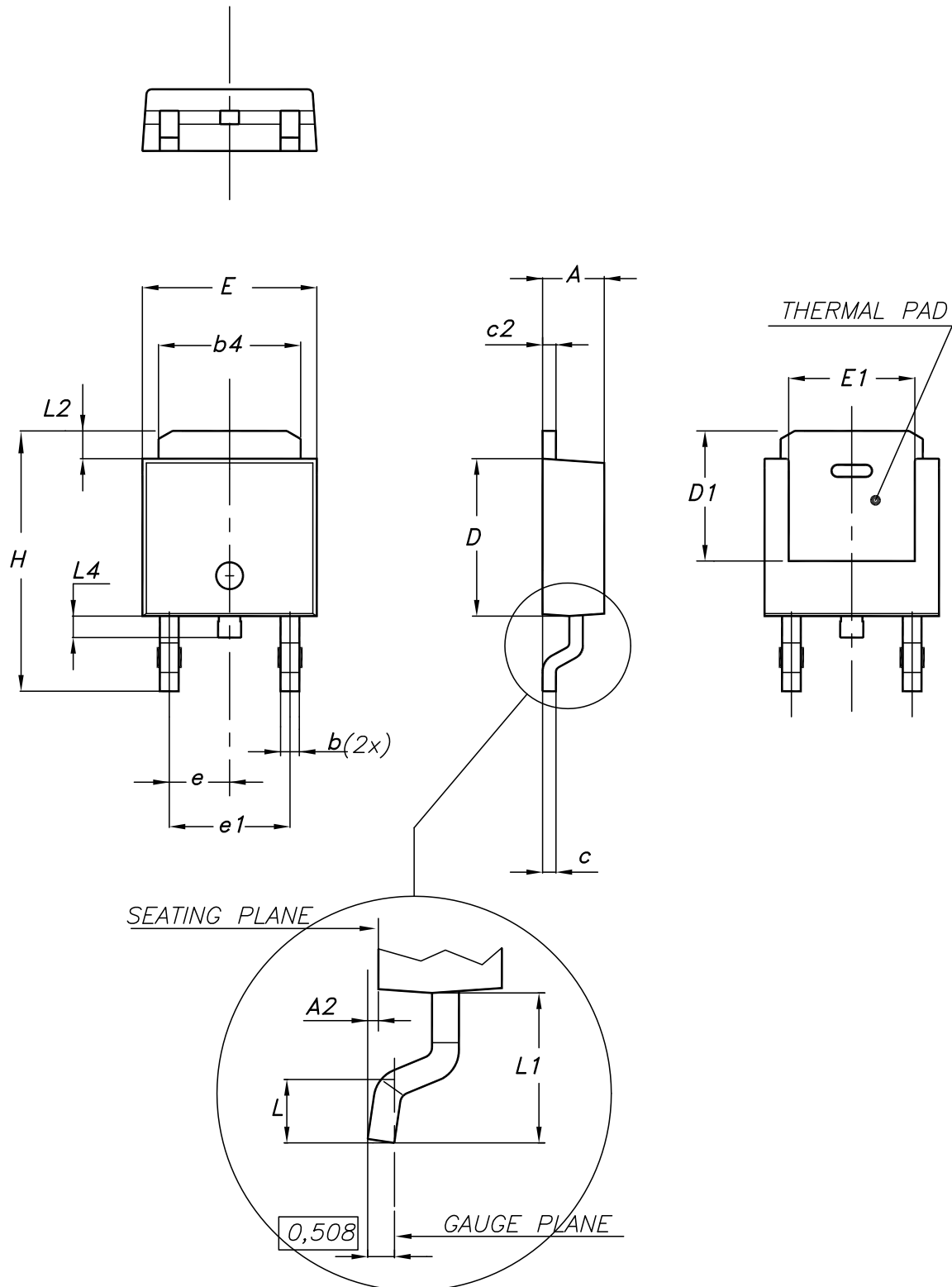
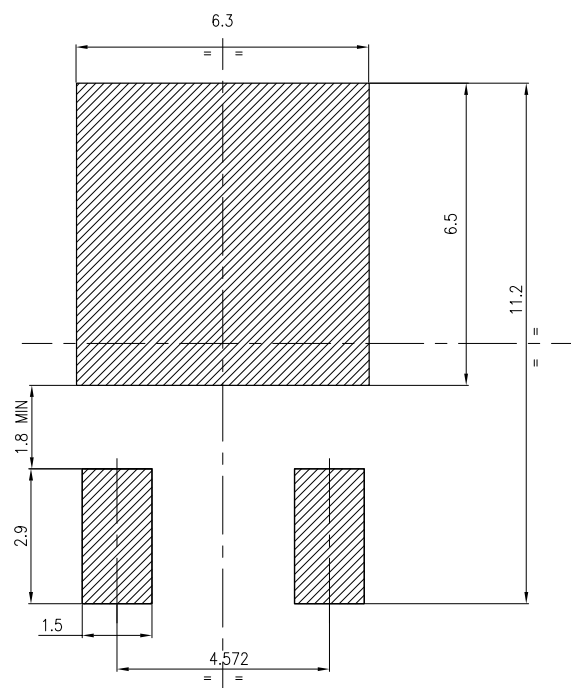

Table 9. DPAK (TO-252) type E mechanical data

Dim.	mm		
	Min.	Typ.	Max.
A	2.18		2.39
A2			0.13
b	0.65		0.884
b4	4.95		5.46
c	0.46		0.61
c2	0.46		0.60
D	5.97		6.22
D1	5.21		
E	6.35		6.73
E1	4.32		
e		2.286	
e1		4.572	
H	9.94		10.34
L	1.50		1.78
L1		2.74	
L2	0.89		1.27
L4			1.02

Figure 21. DPAK (TO-252) recommended footprint (dimensions are in mm)

FP_0068772_25

4.4 DPAK (TO-252) packing information

Figure 22. DPAK (TO-252) tape outline

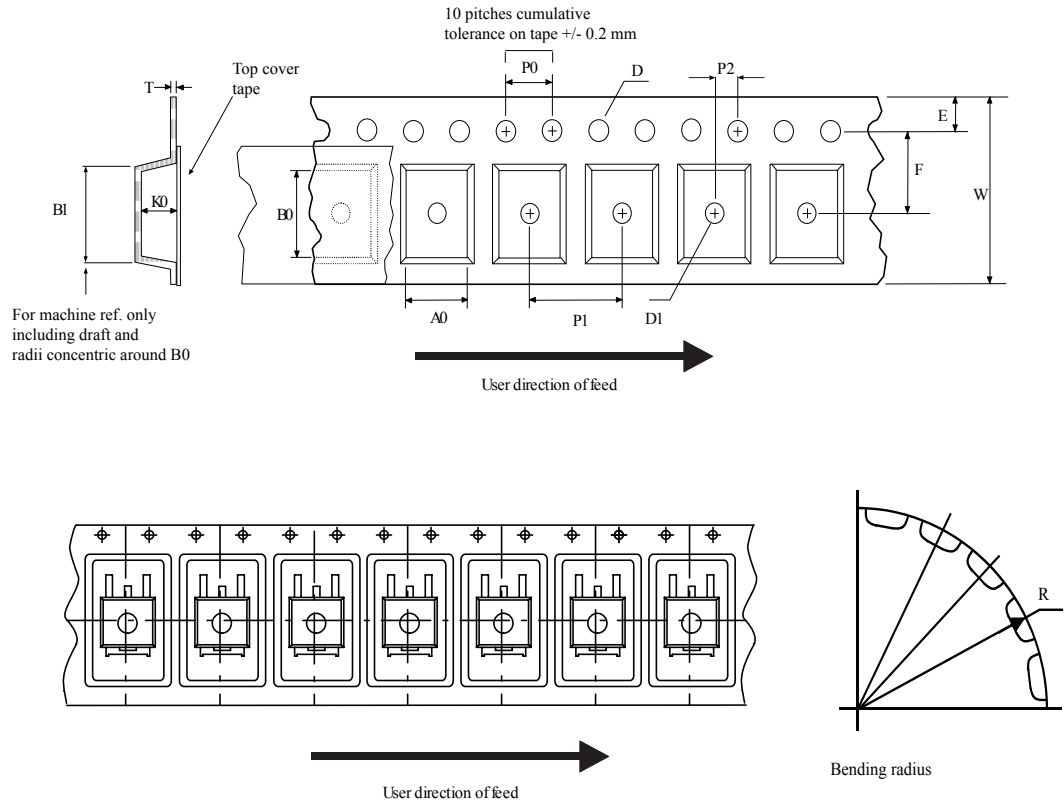

AM08852v1

Figure 23. DPAK (TO-252) reel outline

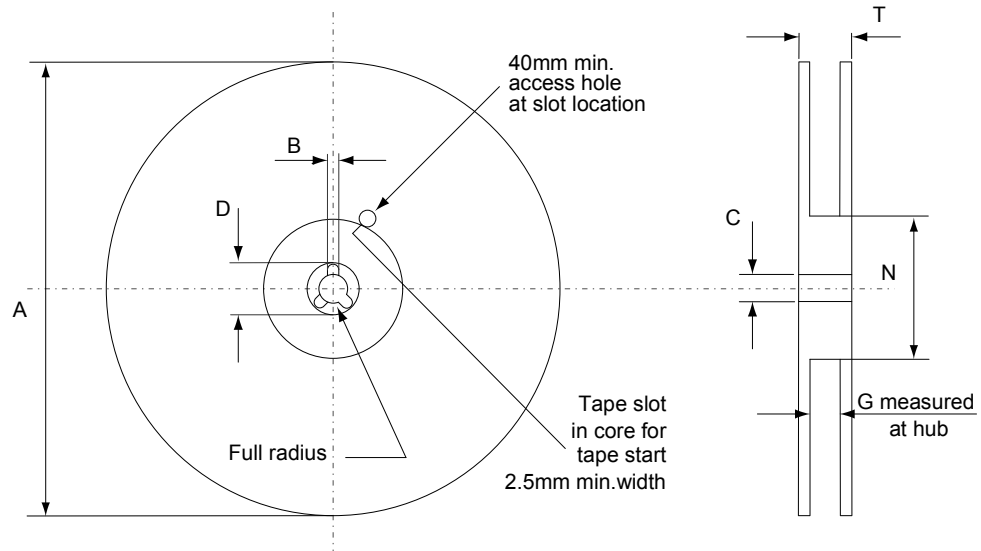

AM06038v1

Table 10. DPAK (TO-252) tape and reel mechanical data

Tape			Reel		
Dim.	mm		Dim.	mm	
	Min.	Max.		Min.	Max.
A0	6.8	7	A		330
B0	10.4	10.6	B	1.5	
B1		12.1	C	12.8	13.2
D	1.5	1.6	D	20.2	
D1	1.5		G	16.4	18.4
E	1.65	1.85	N	50	
F	7.4	7.6	T		22.4
K0	2.55	2.75			
P0	3.9	4.1	Base qty.		2500
P1	7.9	8.1	Bulk qty.		2500
P2	1.9	2.1			
R	40				
T	0.25	0.35			
W	15.7	16.3			

Revision history

Table 11. Document revision history

Date	Version	Changes
26-Jun-2014	1	First release.
14-Nov-2014	2	Updated title and features in cover page Updated <i>Table 3: Thermal data</i> , <i>Table 4: On/off states</i> and <i>Table 5:Dynamic</i> . Updated <i>Figure 2: Safe operating area</i> , <i>Figure 3: Thermal impedance</i> , <i>Figure 6: Normalized V(BR)DSS vs. temperature</i> , <i>Figure 10</i> , <i>Figure 11: Normalized on-resistance vs. temperature</i> and <i>Section 4: Package mechanical data</i> .
09-Aug-2018	3	Removed maturity status indication from cover page. The document status is production data. Updated title and features on cover page. Updated Section 4 Package information . Minor text changes

Contents

1	Electrical ratings	2
2	Electrical characteristics	3
2.1	Electrical characteristics (curves)	5
3	Test circuits	7
4	Package information	8
4.1	DPAK (TO-252) type A package information	8
4.2	DPAK (TO-252) type C package information	10
4.3	DPAK (TO-252) type E package information	12
4.4	DPAK (TO-252) packing information	14
	Revision history	17

IMPORTANT NOTICE – PLEASE READ CAREFULLY

STMicroelectronics NV and its subsidiaries (“ST”) reserve the right to make changes, corrections, enhancements, modifications, and improvements to ST products and/or to this document at any time without notice. Purchasers should obtain the latest relevant information on ST products before placing orders. ST products are sold pursuant to ST’s terms and conditions of sale in place at the time of order acknowledgement.

Purchasers are solely responsible for the choice, selection, and use of ST products and ST assumes no liability for application assistance or the design of Purchasers’ products.

No license, express or implied, to any intellectual property right is granted by ST herein.

Resale of ST products with provisions different from the information set forth herein shall void any warranty granted by ST for such product.

ST and the ST logo are trademarks of ST. All other product or service names are the property of their respective owners.

Information in this document supersedes and replaces information previously supplied in any prior versions of this document.

© 2018 STMicroelectronics – All rights reserved

Mouser Electronics

Authorized Distributor

Click to View Pricing, Inventory, Delivery & Lifecycle Information:

[STMicroelectronics:](#)

[STD12NF06LT4](#)