

Click to view price, real time Inventory,  
Delivery & Lifecycle Information ;

## STF25N60M2-EP

STMicroelectronics

MOSFET N-channel 600 V, 0.175 Ohm typ 18 A MDmesh M2 EP  
Power MOSFET

Any questions, please feel free to contact us.  
[info@kaimte.com](mailto:info@kaimte.com)

## N-channel 600 V, 0.175 $\Omega$ typ., 18 A MDmesh™ M2 EP Power MOSFET in a TO-220FP package

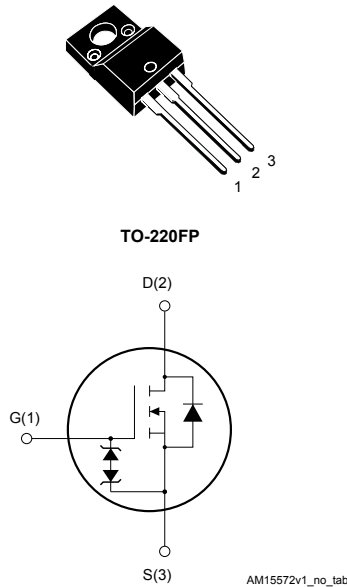

### Features

Order code	$V_{DS}$ at $T_J$ max.	$R_{DS(on)}$ max.	$I_D$
STF25N60M2-EP	650 V	0.188 $\Omega$	18 A

- Extremely low gate charge
- Excellent output capacitance ( $C_{OSS}$ ) profile
- Very low turn-off switching losses
- 100% avalanche tested
- Zener-protected

### Applications

- Switching applications
- Tailored for Very high frequency converters ( $f > 150$  kHz)

### Description

This device is an N-channel Power MOSFET developed using MDmesh™ M2 enhanced performance (EP) technology. Thanks to its strip layout and an improved vertical structure, the device exhibits low on-resistance, optimized switching characteristics with very low turn-off switching losses, rendering it suitable for the most demanding very high frequency converters.

#### Product status link

[STF25N60M2-EP](#)

#### Product summary

<b>Order code</b>	STF25N60M2-EP
<b>Marking</b>	25N60M2EP
<b>Package</b>	TO-220FP
<b>Packing</b>	Tube

# 1 Electrical ratings

**Table 1. Absolute maximum ratings**

Symbol	Parameter	Value	Unit
$V_{GS}$	Gate-source voltage	$\pm 25$	V
$V_{GS}$	Transient gate-source voltage ( $t_p \leq 10$ ns)	$\pm 35$	V
$I_D^{(1)}$	Drain current (continuous) at $T_C = 25$ °C	18	A
$I_D^{(1)}$	Drain current (continuous) at $T_C = 100$ °C	11.3	A
$I_{DM}^{(2)}$	Drain current (pulsed)	72	A
$P_{TOT}$	Total dissipation at $T_C = 25$ °C	30	W
$dv/dt^{(3)}$	Peak diode recovery voltage slope	15	V/ns
$dv/dt^{(4)}$	MOSFET $dv/dt$ ruggedness	50	V/ns
$V_{ISO}$	Insulation withstand voltage (RMS) from all three leads to external heat sink ( $t = 1$ s, $T_C = 25$ °C)	2500	V
$T_{stg}$	Storage temperature range	-55 to 150	°C
$T_j$	Operating junction temperature range		

1. Limited by maximum junction temperature
2. Pulse width limited by safe operating area
3.  $I_{SD} \leq 18$  A,  $di/dt \leq 400$  A/ $\mu$ s,  $V_{DS\ peak} < V_{(BR)DSS}$ ,  $V_{DD} = 400$  V
4.  $V_{DS} \leq 480$  V

**Table 2. Thermal data**

Symbol	Parameter	Value	Unit
$R_{thj-case}$	Thermal resistance junction-case	4.2	°C/W
$R_{thj-amb}$	Thermal resistance junction-ambient	62.5	°C/W

**Table 3. Avalanche characteristics**

Symbol	Parameter	Value	Unit
$I_{AR}$	Avalanche current, repetitive or not repetitive (pulse width limited by $T_{jmax}$ )	3.5	A
$E_{AS}$	Single pulse avalanche energy (starting $T_j = 25$ °C, $I_D = I_{AR}$ , $V_{DD} = 50$ V)	200	mJ

## 2 Electrical characteristics

$T_C = 25\text{ }^\circ\text{C}$  unless otherwise specified

**Table 4. On/off states**

Symbol	Parameter	Test conditions	Min.	Typ.	Max.	Unit
$V_{(BR)DSS}$	Drain-source breakdown voltage	$V_{GS} = 0\text{ V}, I_D = 1\text{ mA}$	600			V
$I_{DSS}$	Zero gate voltage drain current	$V_{GS} = 0\text{ V}, V_{DS} = 600\text{ V}$			1	$\mu\text{A}$
		$V_{GS} = 0\text{ V}, V_{DS} = 600\text{ V}, T_C = 125\text{ }^\circ\text{C}^{(1)}$			100	$\mu\text{A}$
$I_{GSS}$	Gate-body leakage current	$V_{DS} = 0\text{ V}, V_{GS} = \pm 25\text{ V}$			$\pm 10$	$\mu\text{A}$
$V_{GS(th)}$	Gate threshold voltage	$V_{DS} = V_{GS}, I_D = 250\text{ }\mu\text{A}$	3.25	4	4.75	V
$R_{DS(on)}$	Static drain-source on-resistance	$V_{GS} = 10\text{ V}, I_D = 9\text{ A}$		0.175	0.188	$\Omega$

1. Defined by design, not subject to production test.

**Table 5. Dynamic**

Symbol	Parameter	Test conditions	Min.	Typ.	Max.	Unit
$C_{iss}$	Input capacitance		-	1090	-	pF
$C_{oss}$	Output capacitance	$V_{DS} = 100\text{ V}, f = 1\text{ MHz}, V_{GS} = 0\text{ V}$	-	56	-	pF
$C_{rss}$	Reverse transfer capacitance		-	1.6	-	pF
$C_{oss\text{ eq.}}^{(1)}$	Equivalent output capacitance	$V_{DS} = 0\text{ to }480\text{ V}, V_{GS} = 0\text{ V}$	-	255	-	pF
$R_G$	Intrinsic gate resistance	$f = 1\text{ MHz}, I_D = 0\text{ A}$	-	7	-	$\Omega$
$Q_g$	Total gate charge	$V_{DD} = 480\text{ V}, I_D = 18\text{ A},$ $V_{GS} = 0\text{ to }10\text{ V}$ (see Figure 15. Test circuit for gate charge behavior)	-	29	-	nC
$Q_{gs}$	Gate-source charge		-	6	-	nC
$Q_{gd}$	Gate-drain charge		-	12	-	nC

1.  $C_{oss\text{ eq.}}$  is defined as a constant equivalent capacitance giving the same charging time as  $C_{oss}$  when  $V_{DS}$  increases from 0 to 80%  $V_{DSS}$ .

**Table 6. Switching energy**

Symbol	Parameter	Test conditions	Min.	Typ.	Max.	Unit
$E_{(off)}$	Turn-off energy (from 90% $V_{GS}$ to 0% $I_D$ )	$V_{DD} = 400\text{ V}, I_D = 2\text{ A},$ $R_G = 4.7\text{ }\Omega, V_{GS} = 10\text{ V}$	-	7	-	$\mu\text{J}$
		$V_{DD} = 400\text{ V}, I_D = 4\text{ A},$ $R_G = 4.7\text{ }\Omega, V_{GS} = 10\text{ V}$	-	8	-	$\mu\text{J}$

**Table 7. Switching times**

Symbol	Parameter	Test conditions	Min.	Typ.	Max.	Unit
$t_{d(on)}$	Turn-on delay time	$V_{DD} = 300\text{ V}$ , $I_D = 9\text{ A}$ , $R_G = 4.7\ \Omega$ , $V_{GS} = 10\text{ V}$ (see Figure 14. Test circuit for resistive load switching times and Figure 19. Switching time waveform)	-	15	-	ns
$t_r$	Rise time		-	10	-	ns
$t_{d(off)}$	Turn-off delay time		-	61	-	ns
$t_f$	Fall time		-	16	-	ns

**Table 8. Source drain diode**

Symbol	Parameter	Test conditions	Min.	Typ.	Max.	Unit
$I_{SD}$	Source-drain current		-		18	A
$I_{SDM}^{(1)}$	Source-drain current (pulsed)		-		72	A
$V_{SD}^{(2)}$	Forward on voltage	$V_{GS} = 0\text{ V}$ , $I_{SD} = 18\text{ A}$	-		1.6	V
$t_{rr}$	Reverse recovery time	$I_{SD} = 18\text{ A}$ , $di/dt = 100\text{ A}/\mu\text{s}$ , $V_{DD} = 100\text{ V}$ (see Figure 16. Test circuit for inductive load switching and diode recovery times)	-	360		ns
$Q_{rr}$	Reverse recovery charge		-	5		$\mu\text{C}$
$I_{RRM}$	Reverse recovery current	$I_{SD} = 18\text{ A}$ , $di/dt = 100\text{ A}/\mu\text{s}$ , $V_{DD} = 100\text{ V}$ , $T_j = 150\text{ }^\circ\text{C}$ (see Figure 16. Test circuit for inductive load switching and diode recovery times)	-	28		A
$t_{rr}$	Reverse recovery time		-	445		ns
$Q_{rr}$	Reverse recovery charge		-	6.5		$\mu\text{C}$
$I_{RRM}$	Reverse recovery current		-	29		A

1. Pulse width is limited by safe operating area
2. Pulsed: pulse duration = 300  $\mu\text{s}$ , duty cycle 1.5%

## 2.1 Electrical characteristics (curves)

Figure 1. Safe operating area

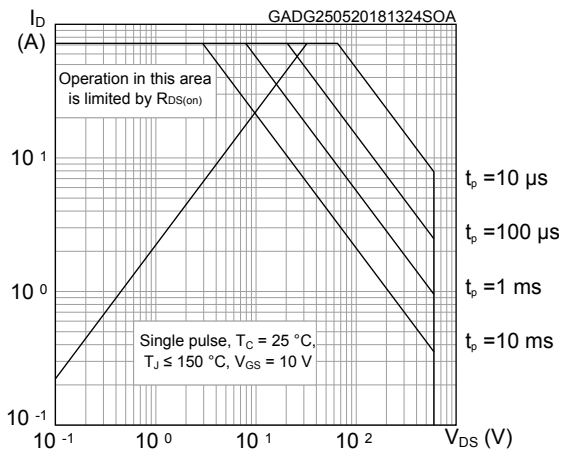

Figure 2. Thermal impedance

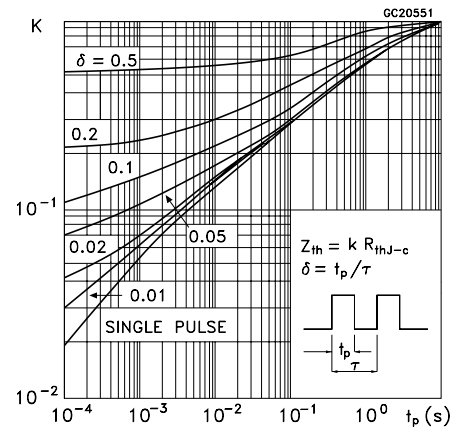

Figure 3. Output characteristics

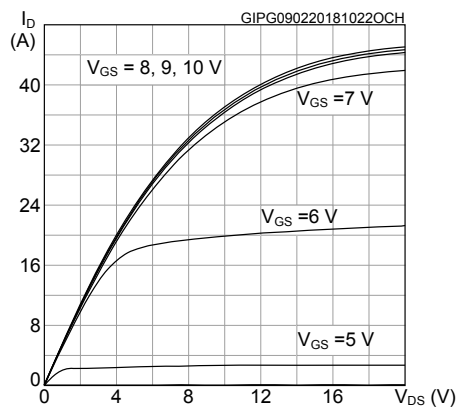

Figure 4. Transfer characteristics

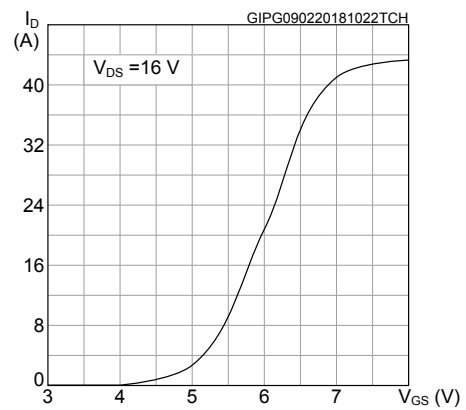

Figure 5. Gate charge vs gate-source voltage

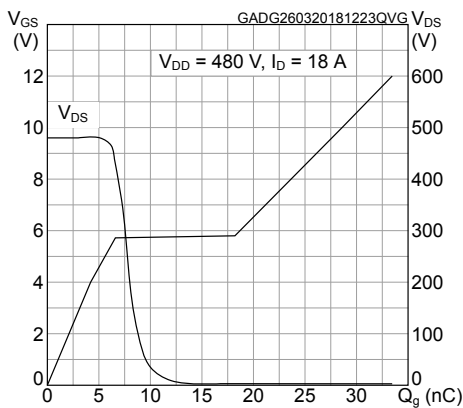

Figure 6. Static drain-source on-resistance

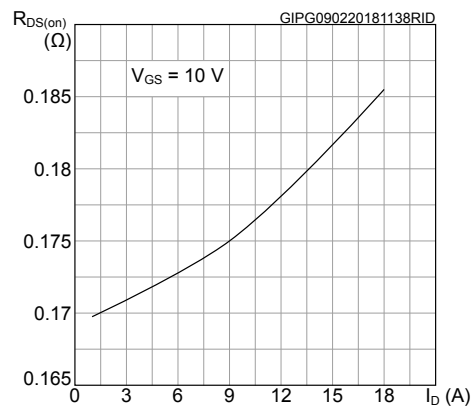

Figure 7. Capacitance variations

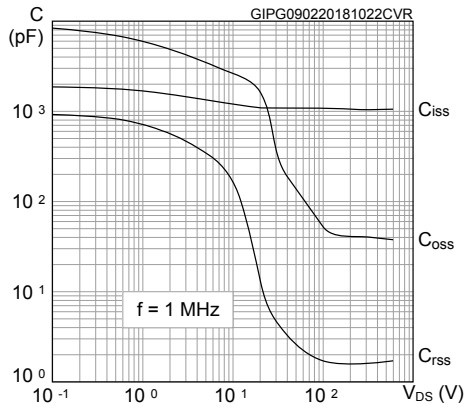

Figure 8. Output capacitance stored energy

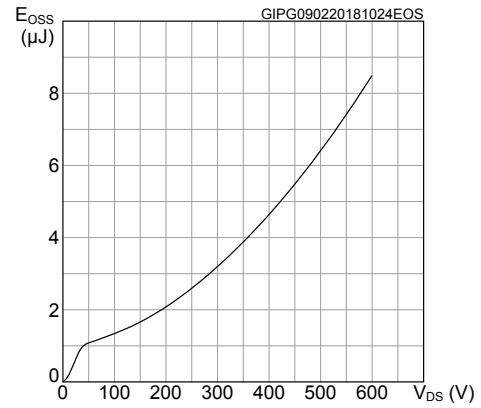

Figure 9. Turn-off switching energy vs drain current

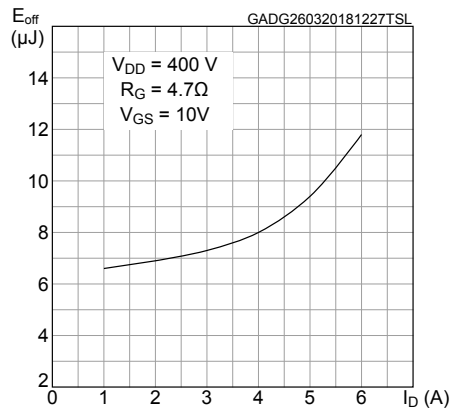

Figure 10. Normalized gate threshold voltage vs temperature

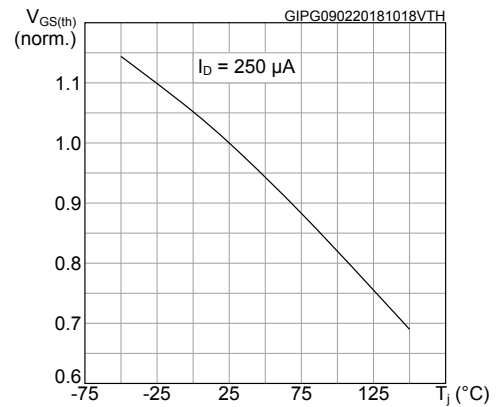

Figure 11. Normalized on-resistance vs temperature

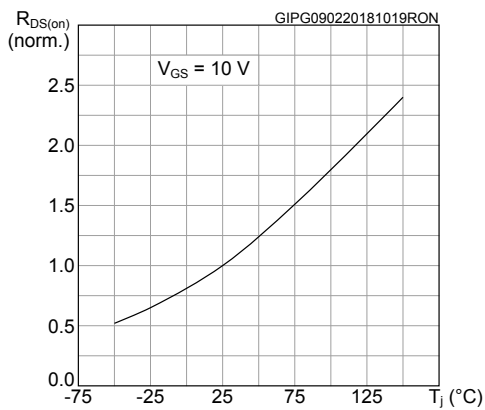
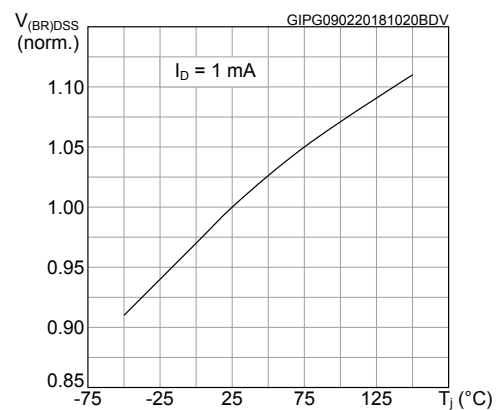
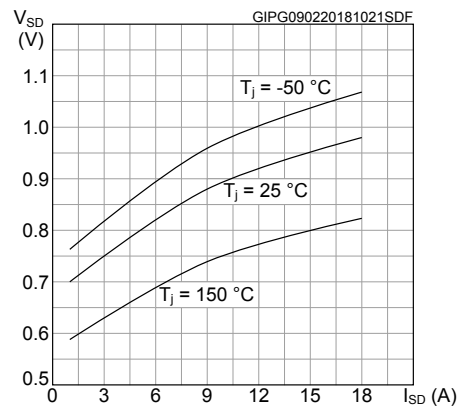

Figure 12. Normalized V(BR)DSS vs temperature

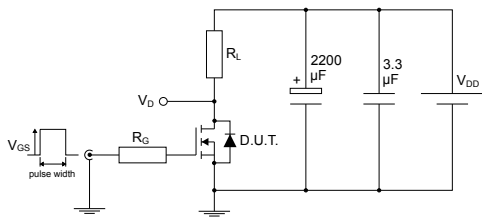

**Figure 13. Source-drain diode forward characteristics**





### 3 Test circuits

**Figure 14. Test circuit for resistive load switching times**

AM01468v1

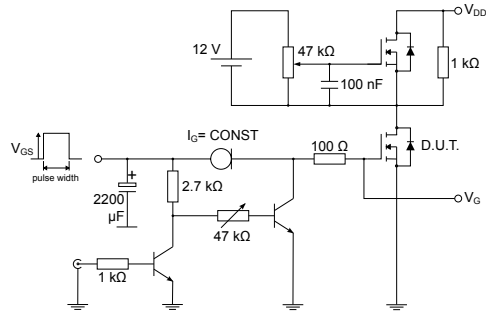
**Figure 15. Test circuit for gate charge behavior**

AM01469v1

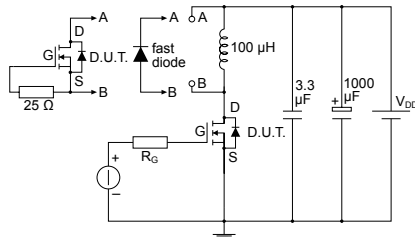
**Figure 16. Test circuit for inductive load switching and diode recovery times**

AM01470v1

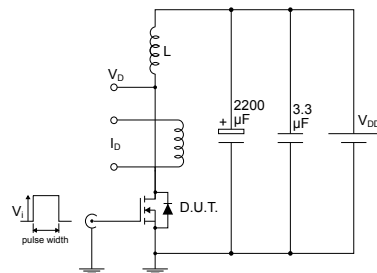
**Figure 17. Unclamped inductive load test circuit**

AM01471v1

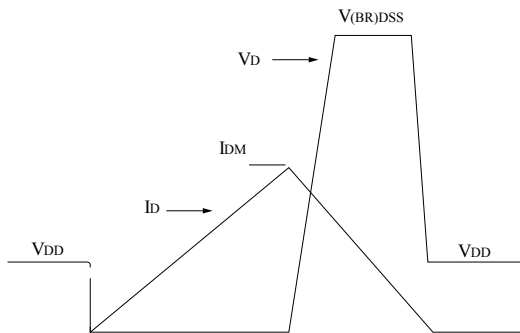
**Figure 18. Unclamped inductive waveform**

AM01472v1

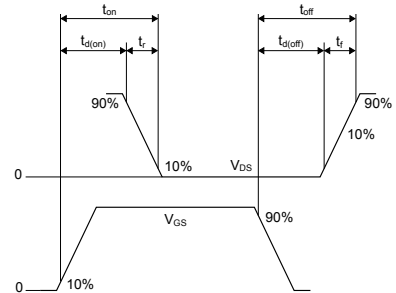
**Figure 19. Switching time waveform**

AM01473v1

## 4 Package information

---

In order to meet environmental requirements, ST offers these devices in different grades of ECOPACK® packages, depending on their level of environmental compliance. ECOPACK® specifications, grade definitions and product status are available at: [www.st.com](http://www.st.com). ECOPACK® is an ST trademark.

## 4.1 TO-220FP package information

Figure 20. TO-220FP package outline

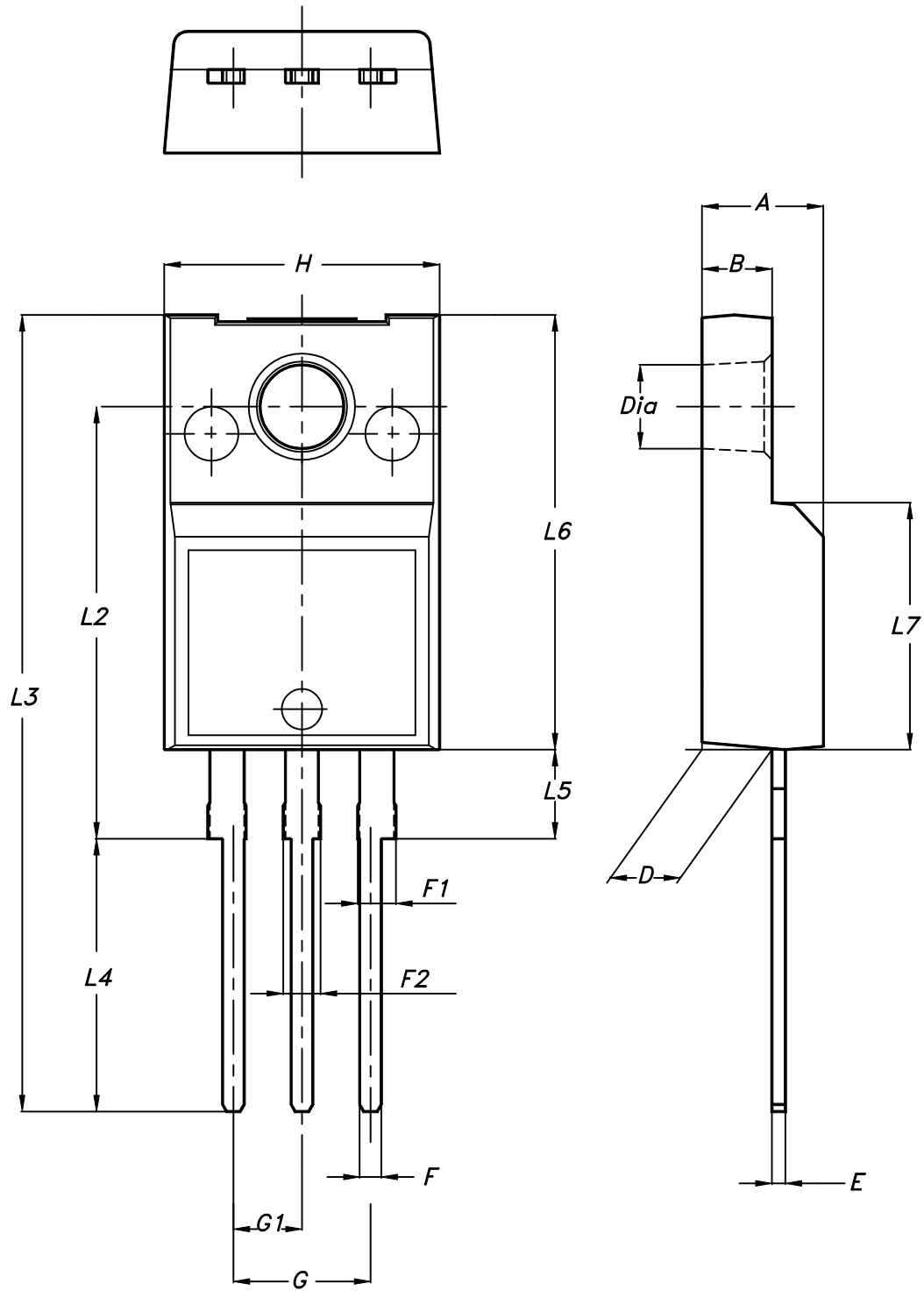

7012510\_Rev\_12\_B

**Table 9. TO-220FP package mechanical data**

Dim.	mm		
	Min.	Typ.	Max.
A	4.4		4.6
B	2.5		2.7
D	2.5		2.75
E	0.45		0.7
F	0.75		1
F1	1.15		1.70
F2	1.15		1.70
G	4.95		5.2
G1	2.4		2.7
H	10		10.4
L2		16	
L3	28.6		30.6
L4	9.8		10.6
L5	2.9		3.6
L6	15.9		16.4
L7	9		9.3
Dia	3		3.2

## Revision history

**Table 10. Document revision history**

Date	Revision	Changes
02-Dec-2014	1	First release.
12-Jan-2015	2	Updated product status from "preliminary data" to "production data".
14-Jan-2015	3	Corrected product status information on cover page.
25-Aug-2016	4	Modified: <i>Table 2: "Absolute maximum ratings"</i> Minor text changes
13-Feb-2018	5	Removed maturity status indication from cover page. Modified <i>Table 1. Absolute maximum ratings, Table 4. On/off states, Table 5. Dynamic, Table 6. Switching Energy, Table 7. Switching times and Table 8. Source drain diode.</i> Updated Section 2.1 Electrical characteristics (curves). Minor text changes.
28-May-2018	6	Updated <a href="#">Table 1. Absolute maximum ratings</a> . Updated <a href="#">Section 2 Electrical characteristics</a> and <a href="#">Section 2.1 Electrical characteristics (curves)</a> . Minor text changes

---

## Contents

<b>1</b>	<b>Electrical ratings</b> .....	<b>2</b>
<b>2</b>	<b>Electrical characteristics</b> .....	<b>3</b>
<b>2.1</b>	<b>Electrical characteristics (curves)</b> .....	<b>5</b>
<b>3</b>	<b>Test circuits</b> .....	<b>8</b>
<b>4</b>	<b>Package information</b> .....	<b>9</b>
<b>4.1</b>	<b>TO-220FP package information</b> .....	<b>9</b>
	<b>Revision history</b> .....	<b>12</b>

**IMPORTANT NOTICE – PLEASE READ CAREFULLY**

STMicroelectronics NV and its subsidiaries (“ST”) reserve the right to make changes, corrections, enhancements, modifications, and improvements to ST products and/or to this document at any time without notice. Purchasers should obtain the latest relevant information on ST products before placing orders. ST products are sold pursuant to ST’s terms and conditions of sale in place at the time of order acknowledgement.

Purchasers are solely responsible for the choice, selection, and use of ST products and ST assumes no liability for application assistance or the design of Purchasers’ products.

No license, express or implied, to any intellectual property right is granted by ST herein.

Resale of ST products with provisions different from the information set forth herein shall void any warranty granted by ST for such product.

ST and the ST logo are trademarks of ST. All other product or service names are the property of their respective owners.

Information in this document supersedes and replaces information previously supplied in any prior versions of this document.

© 2018 STMicroelectronics – All rights reserved

# Mouser Electronics

Authorized Distributor

Click to View Pricing, Inventory, Delivery & Lifecycle Information:

[STMicroelectronics:](#)

[STF25N60M2-EP](#)