

Click to view price, real time Inventory,
Delivery & Lifecycle Information ;

BSS138LT1G

onsemi

MOSFET 50V 200mA N-Channel

Any questions, please feel free to contact us.
info@kaimte.com

BSS138L, BVSS138L

Power MOSFET 200 mA, 50 V

N-Channel SOT-23

Typical applications are DC-DC converters, power management in portable and battery-powered products such as computers, printers, PCMCIA cards, cellular and cordless telephones.

Features

- Low Threshold Voltage ($V_{GS(th)}$: 0.85 V–1.5 V) Makes it Ideal for Low Voltage Applications
- Miniature SOT-23 Surface Mount Package Saves Board Space
- BVSS Prefix for Automotive and Other Applications Requiring Unique Site and Control Change Requirements; AEC-Q101 Qualified and PPAP Capable
- These Devices are Pb-Free, Halogen Free/BFR Free and are RoHS Compliant

MAXIMUM RATINGS ($T_A = 25^\circ\text{C}$ unless otherwise noted)

Rating	Symbol	Value	Unit
Drain-to-Source Voltage	V_{DSS}	50	Vdc
Gate-to-Source Voltage – Continuous	V_{GS}	± 20	Vdc
Drain Current			mA
– Continuous @ $T_A = 25^\circ\text{C}$	I_D	200	
– Pulsed Drain Current ($t_p \leq 10 \mu\text{s}$)	I_{DM}	800	
Total Power Dissipation @ $T_A = 25^\circ\text{C}$	P_D	225	mW
Operating and Storage Temperature Range	T_J, T_{stg}	- 55 to 150	$^\circ\text{C}$
Thermal Resistance, Junction-to-Ambient	$R_{\theta JA}$	556	$^\circ\text{C}/\text{W}$
Maximum Lead Temperature for Soldering Purposes, for 10 seconds	T_L	260	$^\circ\text{C}$

Stresses exceeding those listed in the Maximum Ratings table may damage the device. If any of these limits are exceeded, device functionality should not be assumed, damage may occur and reliability may be affected.



ON Semiconductor®

www.onsemi.com

200 mA, 50 V
 $R_{DS(on)} = 3.5 \Omega$

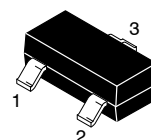
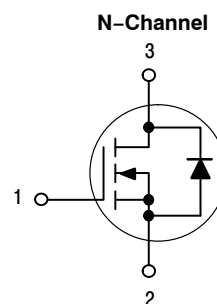

SOT-23
CASE 318
STYLE 21

MARKING DIAGRAM

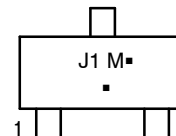

J1 = Device Code
M = Date Code*
▪ = Pb-Free Package

(Note: Microdot may be in either location)

*Date Code orientation and/or overbar may vary depending upon manufacturing location.

ORDERING INFORMATION

Device	Package	Shipping†
BSS138LT1G, BVSS138LT1G	SOT-23 (Pb-Free)	3,000 / Tape & Reel
BSS138LT7G	SOT-23 (Pb-Free)	3,500 / Tape & Reel
BSS138LT3G, BVSS138LT3G	SOT-23 (Pb-Free)	10,000 / Tape & Reel

†For information on tape and reel specifications, including part orientation and tape sizes, please refer to our Tape and Reel Packaging Specifications Brochure, BRD8011/D.

BSS138L, BVSS138L

ELECTRICAL CHARACTERISTICS ($T_A = 25^\circ\text{C}$ unless otherwise noted)

Characteristic	Symbol	Min	Typ	Max	Unit
OFF CHARACTERISTICS					
Drain-to-Source Breakdown Voltage ($V_{GS} = 0\text{ Vdc}$, $I_D = 250\ \mu\text{Adc}$)	$V_{(BR)DSS}$	50	-	-	Vdc
Zero Gate Voltage Drain Current ($V_{DS} = 25\text{ Vdc}$, $V_{GS} = 0\text{ Vdc}$, 25°C) ($V_{DS} = 50\text{ Vdc}$, $V_{GS} = 0\text{ Vdc}$, 25°C) ($V_{DS} = 50\text{ Vdc}$, $V_{GS} = 0\text{ Vdc}$, 150°C)	I_{DSS}	-	-	0.1 0.5 5.0	μAdc
Gate-Source Leakage Current ($V_{GS} = \pm 20\text{ Vdc}$, $V_{DS} = 0\text{ Vdc}$)	I_{GSS}	-	-	± 0.1	μAdc

ON CHARACTERISTICS (Note 1)

Gate-Source Threshold Voltage ($V_{DS} = V_{GS}$, $I_D = 1.0\text{ mAdc}$)	$V_{GS(th)}$	0.85	-	1.5	Vdc
Static Drain-to-Source On-Resistance ($V_{GS} = 2.75\text{ Vdc}$, $I_D < 200\text{ mAdc}$, $T_A = -40^\circ\text{C}$ to $+85^\circ\text{C}$) ($V_{GS} = 5.0\text{ Vdc}$, $I_D = 200\text{ mAdc}$)	$r_{DS(on)}$	-	5.6	10	Ω
Forward Transconductance ($V_{DS} = 25\text{ Vdc}$, $I_D = 200\text{ mAdc}$, $f = 1.0\text{ kHz}$)	g_{fs}	100	-	-	mmhos

DYNAMIC CHARACTERISTICS

Input Capacitance	($V_{DS} = 25\text{ Vdc}$, $V_{GS} = 0$, $f = 1\text{ MHz}$)	C_{iss}	-	40	50	pF
Output Capacitance	($V_{DS} = 25\text{ Vdc}$, $V_{GS} = 0$, $f = 1\text{ MHz}$)	C_{oss}	-	12	25	
Transfer Capacitance	($V_{DG} = 25\text{ Vdc}$, $V_{GS} = 0$, $f = 1\text{ MHz}$)	C_{rss}	-	3.5	5.0	

SWITCHING CHARACTERISTICS (Note 2)

Turn-On Delay Time	($V_{DD} = 30\text{ Vdc}$, $I_D = 0.2\text{ Adc}$)	$t_{d(on)}$	-	-	20	ns
Turn-Off Delay Time		$t_{d(off)}$	-	-	20	

Product parametric performance is indicated in the Electrical Characteristics for the listed test conditions, unless otherwise noted. Product performance may not be indicated by the Electrical Characteristics if operated under different conditions.

1. Pulse Test: Pulse Width $\leq 300\ \mu\text{s}$, Duty Cycle $\leq 2\%$.
2. Switching characteristics are independent of operating junction temperature.

TYPICAL ELECTRICAL CHARACTERISTICS

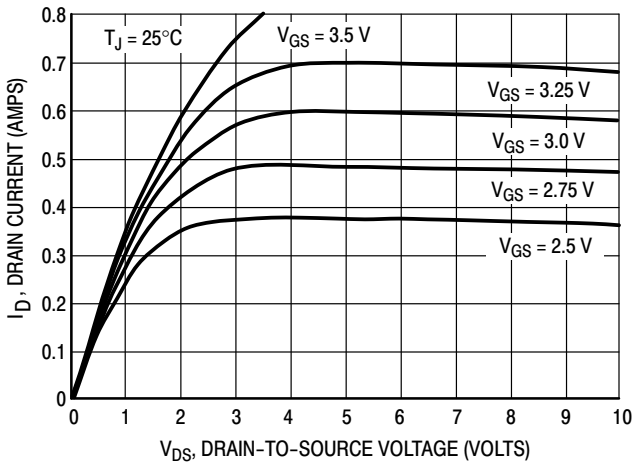

Figure 1. On-Region Characteristics

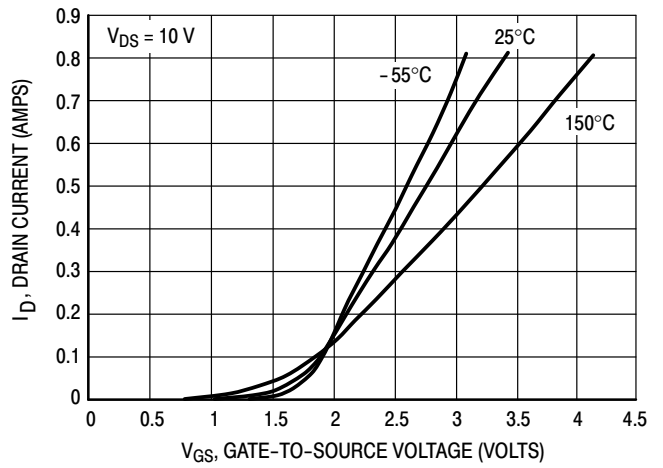

Figure 2. Transfer Characteristics

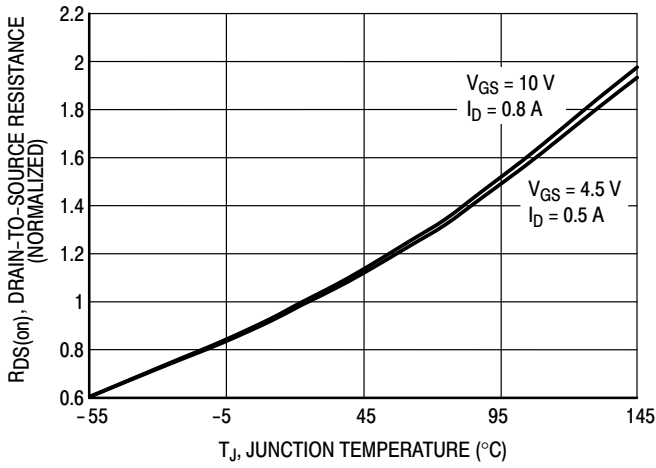

Figure 3. On-Resistance Variation with Temperature

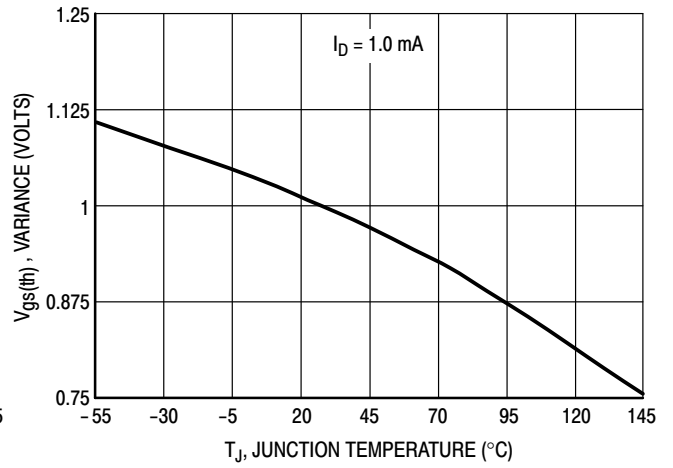

Figure 4. Threshold Voltage Variation with Temperature

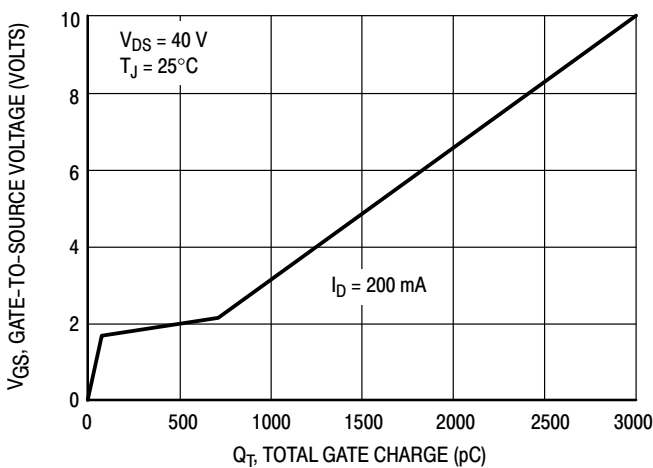

Figure 5. Gate Charge

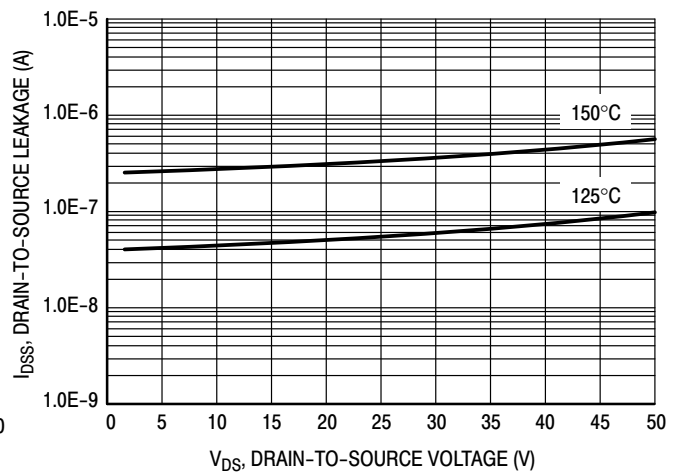

Figure 6. IDSS

BSS138L, BVSS138L

TYPICAL ELECTRICAL CHARACTERISTICS

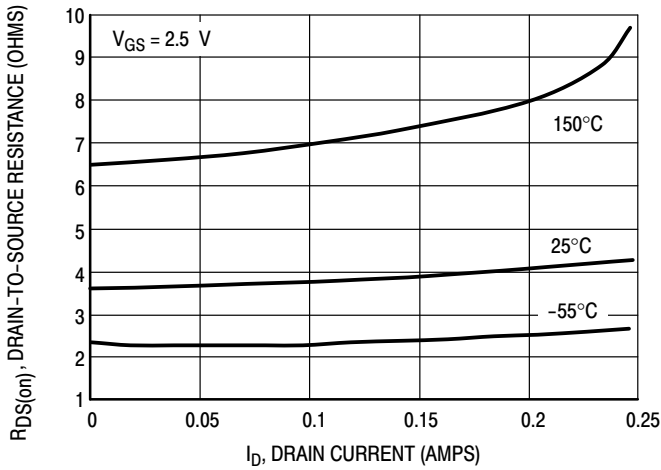

Figure 7. On-Resistance versus Drain Current

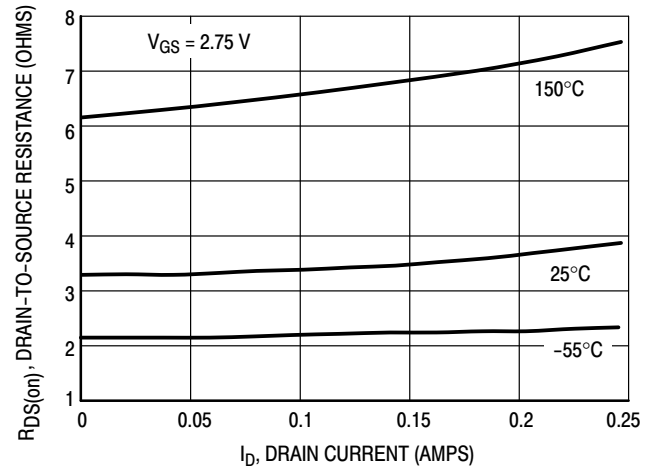

Figure 8. On-Resistance versus Drain Current

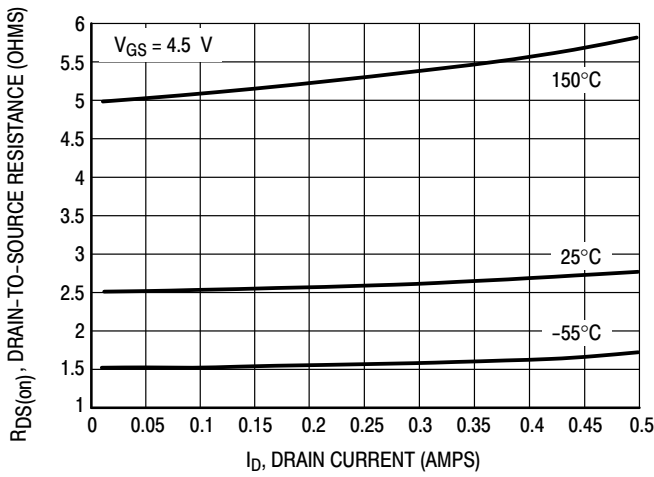

Figure 9. On-Resistance versus Drain Current

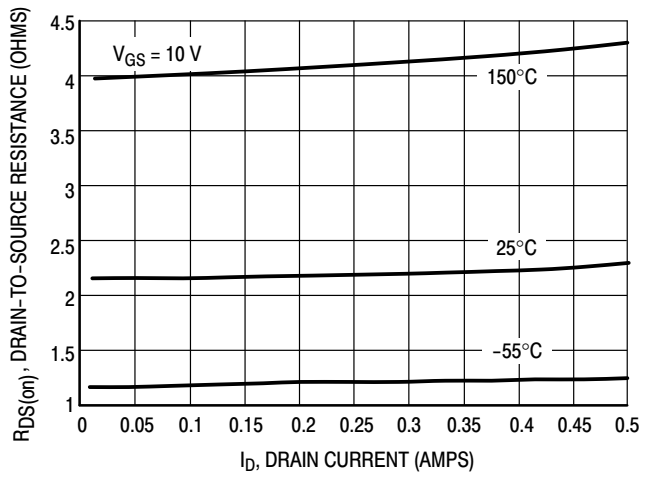

Figure 10. On-Resistance versus Drain Current

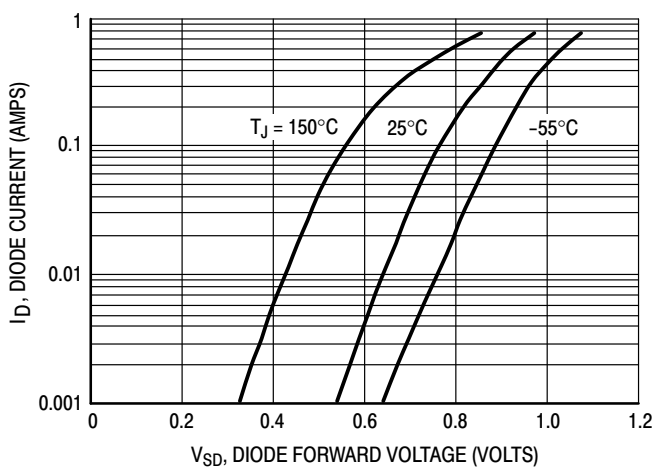

Figure 11. Body Diode Forward Voltage

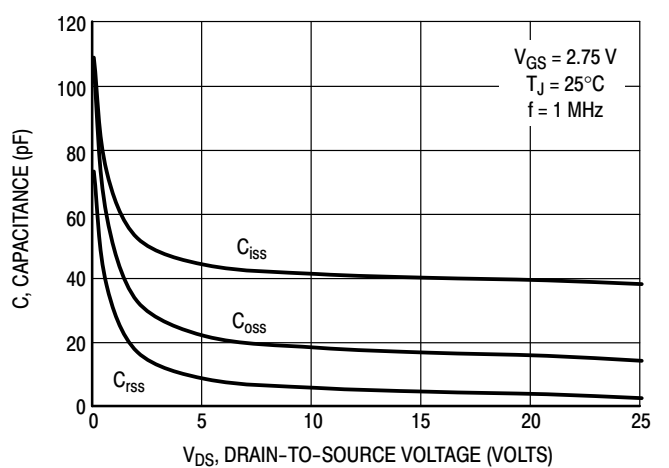

Figure 12. Capacitance

BSS138L, BVSS138L

TYPICAL ELECTRICAL CHARACTERISTICS

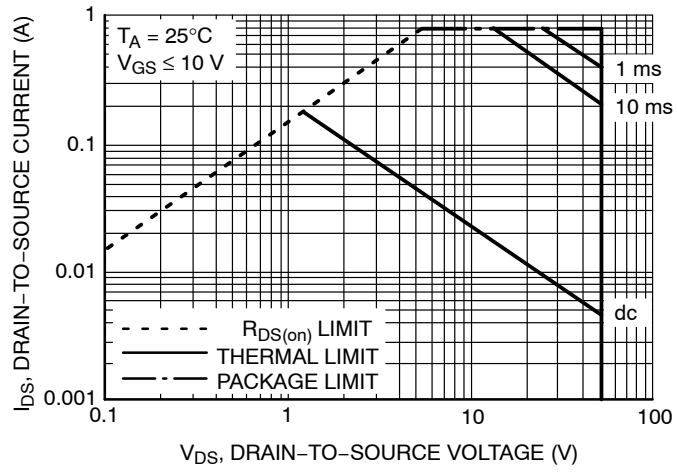
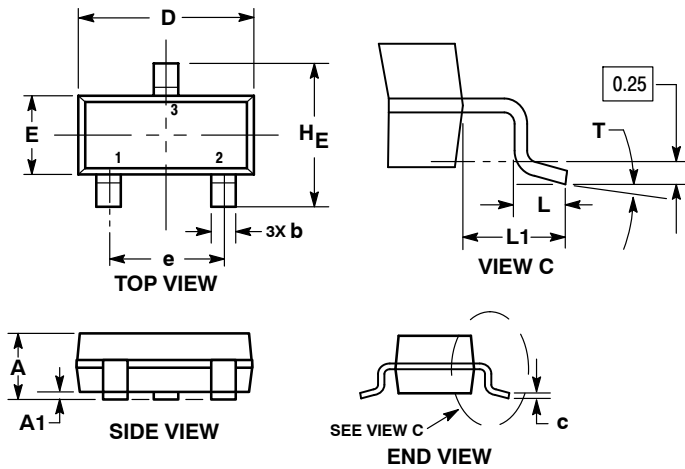

Figure 13. Safe Operating Area

BSS138L, BVSS138L

PACKAGE DIMENSIONS

SOT-23 (TO-236)
CASE 318-08
ISSUE AS



NOTES:

1. DIMENSIONING AND TOLERANCING PER ASME Y14.5M, 1994.
2. CONTROLLING DIMENSION: MILLIMETERS.
3. MAXIMUM LEAD THICKNESS INCLUDES LEAD FINISH. MINIMUM LEAD THICKNESS IS THE MINIMUM THICKNESS OF THE BASE MATERIAL.
4. DIMENSIONS D AND E DO NOT INCLUDE MOLD FLASH, PROTRUSIONS, OR GATE BURRS.

DIM	MILLIMETERS			INCHES		
	MIN	NOM	MAX	MIN	NOM	MAX
A	0.89	1.00	1.11	0.035	0.039	0.044
A1	0.01	0.06	0.10	0.000	0.002	0.004
b	0.37	0.44	0.50	0.015	0.017	0.020
c	0.08	0.14	0.20	0.003	0.006	0.008
D	2.80	2.90	3.04	0.110	0.114	0.120
E	1.20	1.30	1.40	0.047	0.051	0.055
e	1.78	1.90	2.04	0.070	0.075	0.080
L	0.30	0.43	0.55	0.012	0.017	0.022
L1	0.35	0.54	0.69	0.014	0.021	0.027
HE	2.10	2.40	2.64	0.083	0.094	0.104
T	0°	---	10°	0°	---	10°

STYLE 21:
PIN 1. GATE
2. SOURCE
3. DRAIN

RECOMMENDED SOLDERING FOOTPRINT

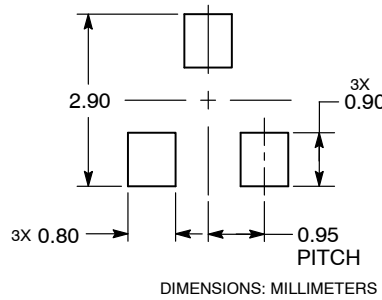

ON Semiconductor and are trademarks of Semiconductor Components Industries, LLC dba ON Semiconductor or its subsidiaries in the United States and/or other countries. ON Semiconductor owns the rights to a number of patents, trademarks, copyrights, trade secrets, and other intellectual property. A listing of ON Semiconductor's product/patent coverage may be accessed at www.onsemi.com/site/pdf/Patent-Marking.pdf. ON Semiconductor reserves the right to make changes without further notice to any products herein. ON Semiconductor makes no warranty, representation or guarantee regarding the suitability of its products for any particular purpose, nor does ON Semiconductor assume any liability arising out of the application or use of any product or circuit, and specifically disclaims any and all liability, including without limitation special, consequential or incidental damages. Buyer is responsible for its products and applications using ON Semiconductor products, including compliance with all laws, regulations and safety requirements or standards, regardless of any support or applications information provided by ON Semiconductor. "Typical" parameters which may be provided in ON Semiconductor data sheets and/or specifications can and do vary in different applications and actual performance may vary over time. All operating parameters, including "Typicals" must be validated for each customer application by customer's technical experts. ON Semiconductor does not convey any license under its patent rights nor the rights of others. ON Semiconductor products are not designed, intended, or authorized for use as a critical component in life support systems or any FDA Class 3 medical devices or medical devices with a same or similar classification in a foreign jurisdiction or any devices intended for implantation in the human body. Should Buyer purchase or use ON Semiconductor products for any such unintended or unauthorized application, Buyer shall indemnify and hold ON Semiconductor and its officers, employees, subsidiaries, affiliates, and distributors harmless against all claims, costs, damages, and expenses, and reasonable attorney fees arising out of, directly or indirectly, any claim of personal injury or death associated with such unintended or unauthorized use, even if such claim alleges that ON Semiconductor was negligent regarding the design or manufacture of the part. ON Semiconductor is an Equal Opportunity/Affirmative Action Employer. This literature is subject to all applicable copyright laws and is not for resale in any manner.

PUBLICATION ORDERING INFORMATION

LITERATURE FULFILLMENT:
Literature Distribution Center for ON Semiconductor
19521 E. 32nd Pkwy, Aurora, Colorado 80011 USA
Phone: 303-675-2175 or 800-344-3860 Toll Free USA/Canada
Fax: 303-675-2176 or 800-344-3867 Toll Free USA/Canada
Email: orderlit@onsemi.com

N. American Technical Support: 800-282-9855 Toll Free
USA/Canada
Europe, Middle East and Africa Technical Support:
Phone: 421 33 790 2910

ON Semiconductor Website: www.onsemi.com
Order Literature: <http://www.onsemi.com/orderlit>

For additional information, please contact your local Sales Representative

Mouser Electronics

Authorized Distributor

Click to View Pricing, Inventory, Delivery & Lifecycle Information:

[ON Semiconductor:](#)

[BSS138LT1G](#) [BSS138LT3G](#) [BVSS138LT1G](#)